

PRIMA'S OFFICIAL STRATEGY GUIDE

**TWO
GAMES IN
ONE
GUIDE**

METROID

PRIME

METROID

FUSION

This game has received the following rating from the ESRB



This game has received the following rating from the ESRB



GAME BOY ADVANCE



primagames.com
METROID-DATABASE.COM

METROID[®]

P R I M E

METROID[®]

F U S I O N



PRIMA'S OFFICIAL STRATEGY GUIDE

DAVID CASSADY
MARK COHEN
TRI PHAM

Prima Games
A Division of Random House, Inc.
3000 Lava Ridge Court
Roseville, CA 95661
(800) 722-3000
www.primagames.com



The Prima Games logo is a registered trademark of Random House, Inc., registered in the United States and other countries. Primagames.com is a registered trademark of Random House, Inc., registered in the United States.

© 2001 by Prima Games. All rights reserved. No part of this book may be reproduced or transmitted in any form or by any means, electronic or mechanical, including photocopying, recording, or by any information storage or retrieval system without written permission from Prima Games. Prima Games is a division of Random House, Inc.

Product Manager: Sara E. Wilson
Project Editor: Sara E. Wilson
Editorial Assistant: Carrie Ponseti
Design and Layout: Jody Seltzer and Melissa Francis

© 2002 Nintendo. TM, ®, Game Boy Advance, and the Nintendo GameCube logo are trademarks of Nintendo.

All products and characters mentioned in this book are trademarks of their respective companies.

Please be advised that the ESRB rating icons, "EC", "K-A", "E", "T", "M", "AO" and "RP" are copyrighted works and certification marks owned by the Interactive Digital Software Association and the Entertainment Software Rating Board and may only be used with their permission and authority. Under no circumstances may the rating icons be self-applied or used in connection with any product that has not been rated by the ESRB. For information regarding whether a product has been rated by the ESRB, please call the ESRB at 1-800-771-3772 or visit www.esrb.org. For information regarding licensing issues, please call the IDSA at (212) 223-8936. Please note that ESRB ratings only apply to the content of the game itself and does NOT apply to the content of this book.

IMPORTANT:

Prima Games has made every effort to determine that the information contained in this book is accurate. However, the publisher makes no warranty, either expressed or implied, as to the accuracy, effectiveness, or completeness of the material in this book; nor does the publisher assume liability for damages, either incidental or consequential, that may result from using the information in this book. The publisher cannot provide information regarding game play, hints and strategies, or problems with hardware or software. Questions should be directed to the support numbers provided by the game and device manufacturers in their documentation. Some game tricks require precise timing and may require repeated attempts before the desired result is achieved.

ISBN: 0-7615-3959-X

Library of Congress Catalog Card Number: 2002114062

Printed in the United States of America

02 03 04 XX 10 9 8 7 6 5 4 3 2 1

Acknowledgments

Prima Games and the authors would like to extend heart-felt thanks and appreciation to our friends at Nintendo of America for their assistance: Edward A. Ridgeway, Scott Callahan, Robert Fuller II, Jeff Olsen, Michael Leslie, Stephen Ward, Cammy Budd, and Amanda Bowes

Contents

METROID® PRIME

- The Hunter Returns**1
- The Basics of *Metroid Prime***2
 - Basic Controls2
 - The Interface3
 - Samus's Equipment4
 - Adventuring in Tallon IV8
- Space Pirate Frigate**9
 - Learning the Ropes9
 - Boss Battle: Parasite Queen10
 - Escaping the Space Pirate Frigate10
- Universe Map**11
- Tallon Overworld Map**12
- Chozo Ruins Map**13
- Magmoor Caverns Map**14
- Phendrana Drifts Map**15
- Phazon Mines Map**16
- Impact Crater Map**17
- Tallon Overworld First Visit**18
 - Finding Chozo Ruins18
- Chozo Ruins First Visit**19
 - Boss Battle: Hive Mecha20
 - The Missile Launcher21
 - Boss Battle: Plated Beetle21
 - The Morph Ball21
 - The Charge Beam22
 - The Morph Ball Bomb23
 - Boss Battle: Incinerator Drone23
 - The Varia Suit24
 - Boss Battle: Flaahgra25
- Magmoor Caverns First Visit**27
 - Collecting the Goodies27
- Phendrana Drifts First Visit**30
 - The Boost Ball30
- Tallon Overworld Second Visit**32
 - The Space Jump Boots32
 - The Artifact of Truth33
- Phendrana Drifts Second Visit**34
 - The Artifact of Strength34
 - The Wave Beam34
 - Boss Battle: Sheegoth35
 - The Super Missile36
 - The Thermal Visor38
 - The Spider Ball39
 - Boss Battle: Thardus40
- Chozo Ruins Second Visit**41
 - Passage From Magmoor Caverns to Chozo Ruins41
 - The Ice Beam43
- Phendrana Drifts Third Visit**44
 - The Gravity Suit45

- Tallon Overworld Third Visit**46
 - Passage to Phazon Mines46
- Phazon Mines First Visit**48
 - The Power Bomb48
 - The Grapple Beam50
- Tallon Overworld Fourth Visit**52
 - The X-Ray Visor and Artifact of Chozo52
 - The Artifact of Nature and the Ice Spreader53
 - The Plasma Beam53
 - Time to Upgrade54
- Phazon Mines Second Visit**56
 - The Flamethrower, Artifact of Warrior, and More56
 - The Phazon Suit56
 - Boss Battle: Omega Pirate58
- Meta Ridley and the Impact Crater**60
 - Returning the Artifacts60
 - Impact Crater: The Final Showdown61
- Enemies: Dangers on Tallon IV**64
- Upgrades and Log Book Entries**75
 - Finding it All75
- Metroid Prime* Game Secrets**81
 - Endings81
 - Hard Mode81
 - Image Gallery81
 - Connecting *Metroid Fusion* for the Game Boy Advance81

METROID® FUSION

- Meet Samus Aran**82
 - Introduction82
 - Samus Aran's Lost Weapons and Abilities82
- Special Blocks**86
- Main Deck**88
- Quarantine Bay**88
- Sector 1**91
- Sector 2**95
- Sector 4**99
- Sector 3**103
- Sector 6**106
- Sector 5**109
- Sector 3**112
- Main Deck**115
- Sector 5**116
- Main Deck**119
- Sector 2**122
- Sector 5**126
- Sector 4**129
- Sector 6**133
- Sector 1**136
- Main Deck**140



The Hunter Returns

It's been a long time since we last adventured with Samus Aran, but she's back and better than ever. Not only do you find her starring in *Metroid Prime* for the Nintendo GameCube, but also in *Metroid Fusion* for the Game Boy Advance. Both of these massive games push your skills to the limit as you deal with the terrifying Metroid threat and those who would seize the Metroid's horrific powers for their very own. Fear not, devoted gamer. We're here to help you every step of the way.

Contained within this guide is everything you need to know about both *Metroid Prime* and *Metroid Fusion*. We walk you through both games with maps, full walkthroughs, surefire boss strategy, and lots more.

Both games allow you a great deal of freedom to explore on your own and discover the many hidden secrets tucked within both worlds. There's no specific way in which either game must be played to guarantee your success, but there are things you need to know that will make your adventures much easier and turn you into a one-person parasite-pulverizing machine. We've customized this book to give you as little or as much help as you like. Maybe you've already played through both games and you're just wondering what you've missed. Maybe you need a push in the right direction. Either way, you'll find exactly what you need in the pages to come. Every upgrade, power-up, secret passage, map, and bit of data you'll need is at your disposal. How you choose to use them is up to you.

The time for talk is over. Evil waits and the darkness grows ever stronger. It's time to charge your weapons and strap on your Power Suit. The hunter has returned, and the parasites are going to pay.

The Basics of *Metroid Prime*

SAMUS RETURNS

Those gamers who have been around awhile will surely remember the astounding adventures of Samus. It's been a long time since she last graced our televisions, but she's back and better than ever. For those of you who've yet to experience *Metroid*, you're in for a treat. It can be said that *Metroid* is one of the greatest game series ever to grace console and handheld systems. *Metroid* is a game unlike any other, and as such, there's lots to know before you go off into battle. Even if you're a veteran, it's probably been a long time since you took control of Samus Aran. Take a few minutes to flip through this chapter, and you'll enter Tallon IV better prepared for the adventure to come.

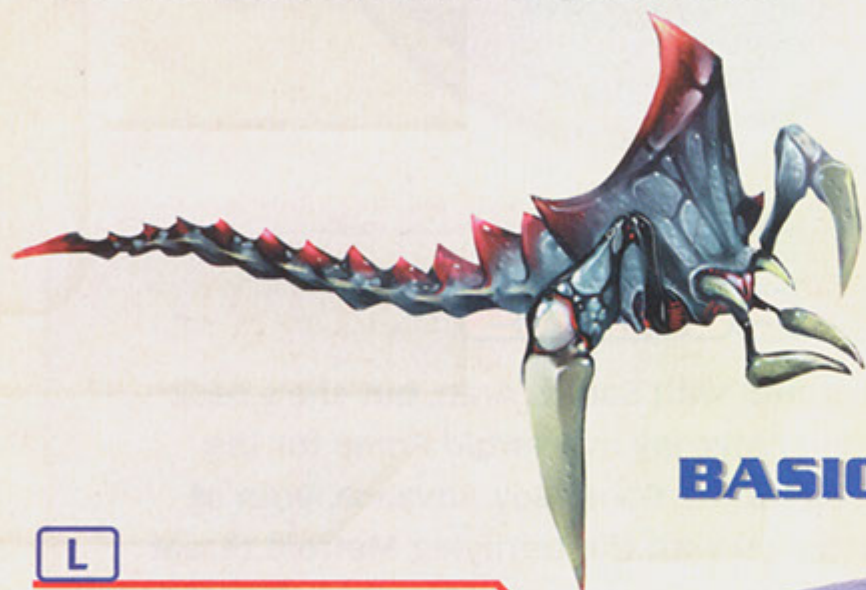

BASIC CONTROLS

L
Lock onto enemies, scan objects in Scan mode, use Grapple Beam

Control Stick

Move Samus, look around, aim (holding **R**)

+ Control Pad

Switch Visors



START
Pause the game and access Samus's databanks

R
Look around

Z
Call up map

Y
Fire missiles, lay Power Bombs in Morph Ball mode

X
Switch between standard and Morph Ball modes

A
Fire beam weapon, lay bombs in Morph Ball mode

B
Jump, activate Boost Ball in Morph Ball mode

C
Select beam weapon

THE INTERFACE

As you play, a great deal of information is displayed onscreen. These bits of information are the Power Suit's diagnostic functions. It's important that you understand the information you're seeing because it's vital to your survival.



Radar

This displays any enemies in the immediate area. Though using the radar isn't always necessary, it will help you a great deal in situations where you're unsure of an enemy's location.

Threat Assessment

It warns you when Samus is near volatile substances or dangerous environments like extreme heat. As you draw closer to a dangerous area, the Threat Assessment meter will fill. When you're very close to an area or object that could be harmful, an exclamation point appears at the top of the meter. Should you draw any closer to the object or area, you'll begin to take damage unless Samus is wearing a suit with the ability to protect her.

Visors

There are several Visors available to you. You begin the game with the Combat and Scan Visors, but eventually you'll find the Thermal and X-ray Visors. Each Visor is used for a different purpose, which we'll cover later. To switch between them, just press on the + Control Pad in the proper direction.

Energy Reserves

This bar and number indicate the amount of Energy that remains in the Power Suit. Energy powers the suit's shielding. Each time you take a hit, the attack drains a bit of Energy from the reserves. Should the Energy supply be completely drained, Samus will fall to the enemy's attack and be defeated.

Samus's Energy reserves can be restored by collecting power-ups that are dropped from defeated enemies, or by visiting Save Stations or her ship. Finding and collecting Energy Tanks, which are hidden throughout the game, increases her Energy capacity. These additional tanks are represented by squares above the white Energy line. A white tank is full, containing 100 Energy units, and gray tanks are empty. Energy collected throughout the game is placed in the bar first. When the bar is filled, one of the reserve tanks turns white, if available, and the bar is made available for refilling. Visiting a Save Station or your ship refills all of your tanks and bar.

NOTE

Please note that the heads-up display's (HUD's) layout changes depending upon the visor being used. The layout discussed is that for the Combat Visor. The same information is displayed for other visors, but in different locations around the screen.

Map

This displays the room you're currently exploring and the immediate area. Here you'll be able to see nearby doors and get a general idea of the direction you're facing. You can view a larger version of the map by pressing . There you'll be able to see all of the areas you've explored. This is especially useful when attempting to travel great distances.

Missile Reserves

This long meter displays the number of missiles Samus has available. As you use missiles and collect power-ups, the Missile Reserves meter will rise and fall. When you begin the game, you'll be able to hold only five missiles at a time, but when you find Missile Expansions your maximum capacity will grow.

Targeting Reticule

It's used to track and target enemies and scan points. If you press , you'll lock onto a target or scan point, allowing you to easily scan or blast the targeted object or enemy. The targeting reticule automatically shifts between nearby targets as you shoot or scan the area to make fighting easier, but the range is limited.

Beam Weapons

These icons represent the beam weapons you hold. You can switch between these weapons by pressing on in the proper direction. At first you'll have only the Power Beam at your disposal, but your arsenal will grow over the course of the game.

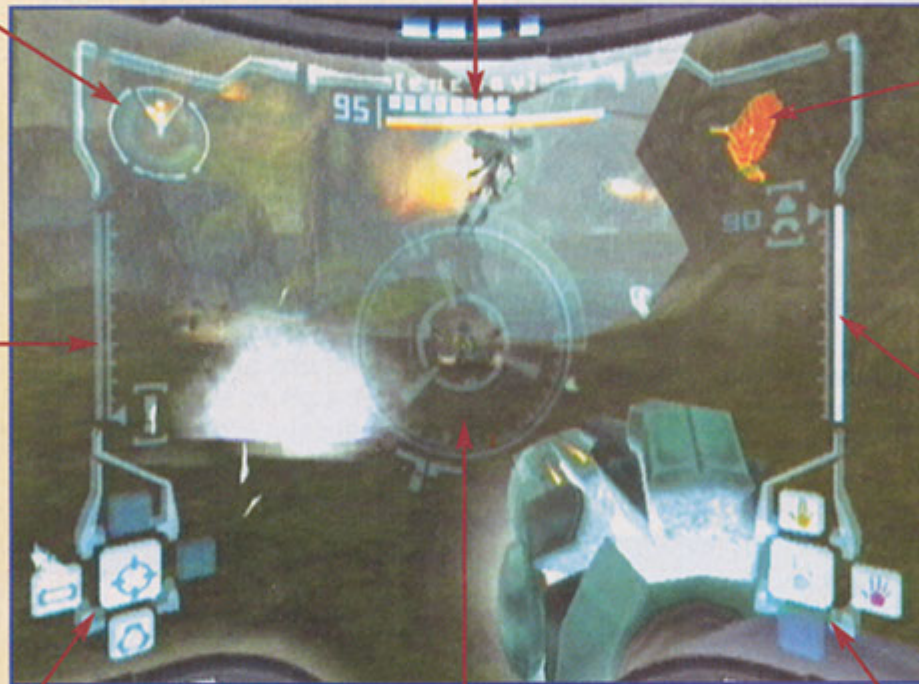

SAMUS'S EQUIPMENT

Samus may be a powerful warrior, but she's far from invincible. What really makes her so tough is the incredible gear she employs in the battlefield and her skill at using it. You begin the game with only the most basic gear, but Samus's powers will grow over time as she finds additional gear hidden throughout the world. How much or how little of the equipment you find is up to you and the amount of exploration you're willing to do.

Suits

Power Suit



The Power Suit is what keeps Samus going and gives her such fantastic powers. Built by the Chozo people, the suit not only protects her from enemy attacks, but also allows her to travel through water and space because of its amazing life-support systems. The Power Suit uses Energy to power its shields, which protect Samus from enemy attacks. Though the suit is incredibly strong, it isn't invulnerable. Each time Samus is struck by an enemy attack, some of the suit's Energy is drained. If the suit's Energy supply becomes completely exhausted, it will be unable to protect Samus, and the enemy will drop her. You can restore the suit's Energy reserves by collecting Energy power-ups and by visiting Save Stations or Samus's ship.

Varia Suit



The Varia Suit is an upgrade to the Power Suit. It maintains all the normal functions, but also protects Samus from extreme heat, which is found in Magmoor Caverns and other areas.

Gravity Suit



The Gravity Suit is the second upgrade to the Power Suit. It performs the same functions as the previous two suits, but it makes traveling through water much easier. Once Samus is clad in the Gravity Suit, she'll be able to pass through deep water as if she were on land, and her vision will be vastly improved in such areas.

Phazon Suit



This is the last of the Power Suit upgrades. It adds protection from Phazon radiation in addition to maintaining all other suit functions. Normally, you will rapidly take damage while standing near Phazon deposits, but with the Phazon Suit you'll be able to pass through such areas without taking so much as a scratch. The Phazon Suit also has increased resilience, so Samus takes less damage from enemy attacks.

Armaments

Power Beam



This is Samus's main weapon. It's used to attack enemies and to open most doors. The Power Beam doesn't rely on ammunition, so it may be fired constantly by rapidly tapping **A**. Though the Power Beam is effective against most enemies and has a rapid rate of fire, it lacks power on its own. Its effectiveness is greatly improved once Samus locates the Charge Beam power-up, which allows you to charge a strong blast by holding **A** for a short time.

NOTE

The Charge Beam has a tractor-beam effect, which allows you to pull power-ups toward you. This is especially useful in situations where the power-ups are hanging over a pit or are in a dangerous area. It's also handy in fights when you can't afford to take your eyes off of the enemy.

The Power Beam can be further strengthened through the addition of the Super Missile Combo, which allows you to fire a fully powered blast and five missiles. This can be used to destroy Cordite and to devastate enemies. This is a single blast.



Wave Beam



The Wave Beam allows you to fire three streams of electric energy at your opponents. Though this weapon has a slower rate of fire than the Power Beam, it's especially effective against mechanical and electrical enemies. It also can envelop enemies in an electrical field when powered up using the Charge Beam. The electrical field momentarily stuns most enemies. The Wave Beam is also used to unlock purple doors, and it can be used to restore power to some objects.

You can increase the Wave Beam's power by finding the Wavebuster (Wave Beam Combo). Using a fully powered blast in combination with missiles, the Wavebuster emits a powerful stream of energy that seeks and destroys enemies in the area. It's best used against large groups of enemies. This is a continuous blast.

Ice Beam



The Ice Beam has a frigid attack that's particularly effective against fire enemies. Its rate of fire is very slow, which could limit its usefulness in battles with multiple enemies. However, it makes up for this lack by temporarily freezing most enemies. Using the Ice Beam, Samus can freeze enemies for a long time. The Ice Beam's freezing properties can also be used to freeze flame spouts and machinery, which makes some areas much easier to traverse. Use this weapon to unlock white doors.

The Ice Beam can be further upgraded by finding the Ice Spreader (Ice Beam Combo). With a fully charged blast in combination with missiles, the Ice Spreader is able to freeze a large area and any nearby enemies. This is a single blast.

Plasma Beam



When you need to heat things up, the Plasma Beam is the weapon of choice. Its super-heated plasma can set enemies on fire, which may eventually overcome them. When charged up using the Charge Beam, the super blast can actually incinerate enemies. The Plasma Beam is most effective when used against ice enemies. Use it to unlock red doors.

Power up the Plasma Beam by finding the Flamethrower, (Plasma Beam Combo), which allows you to fire a stream of superheated plasma. You can train the Flamethrower around a room to fry your enemies to a crisp. This is a continuous blast.

Phazon Beam



The Phazon Beam isn't a weapon you pick up. Once you have the Phazon Suit, you'll be able to stand in liquid pools of Phazon and draw power from them to create a lethal blast. To use the weapon, all you must do is stand in a Phazon pool. You'll notice that your weapon's appearance will change. Press **A** to unleash a continuous beam of energy. Once the pool has dried up, you'll need to find another source of energy.

Missiles



The Missile Launcher is the first weapon upgrade you find. You can fire missiles by pressing **Y**. Their concussive blasts are very powerful against most enemies, and they can home in on targeted enemies. Your Missile Launcher has limited ammunition, but you can refill your supply by collecting power-ups dropped by defeated enemies. At first you are able to hold only five missiles at a time, but over time you'll be able to increase your maximum capacity by collecting the Missile Expansions hidden around the world. Each Missile Expansion increases your maximum capacity by five. Missiles can be used to destroy Radion and Brinstone structures.

Visors

Combat Visor



This is the default visor that is used when attacking enemies. It provides helpful data about Samus's status, and it displays a targeting reticle that highlights your current target.



Scan Visor



The Scan Visor is used for scanning objects and enemies to learn valuable information, or to activate switches. When activated, the Scan Visor displays a magnifying reticle in the center of the screen. Any object that can be scanned has an orange or red icon displayed on it. Orange icons are typically found on unimportant objects. Red icons are displayed anywhere critical actions are required, or on objects that hold information that may be added to your Log Book.

Press and hold **L** to scan the object. Scanning takes several moments. When the scan is complete, any information learned about the object is displayed onscreen. The first time enemies and some objects are scanned, the information gained is added to your Log Book for future reference.

TIP

While the Scan Visor is active, you are unable to use your weapons. Press **A** to quickly switch back to the Combat Visor in hostile situations.

Thermal Visor



The Thermal Visor allows Samus to track enemies by their heat signatures. This makes fighting in the dark or cloudy areas much easier, and it can help you find power-ups and doors quickly. In hot areas the Thermal Visor is considerably less effective, because the surroundings hide

enemy heat signatures. You'll also have difficulty using it against enemies with body temperatures similar to their environments, such as machines and cold enemies. At times you'll find doors and equipment lacking power. Use the Thermal Visor to locate hidden power conduits, which can be reactivated by using the Wave Beam.

X-ray Visor



This wondrous piece of equipment allows Samus to look through some walls to find hidden rooms and alcoves. More importantly, it's used to find invisible platforms in some areas. Should you find an area where it seems there's no way to cross, try peeking through the X-ray Visor to see if there's a hidden path. This visor also allows you to easily track any enemies that use optical camouflage, and sometimes reveals hidden weaknesses in enemies.

Morph Ball



Once Samus finds the Morph Ball power-up, she'll be able to transform herself into a sphere, which allows her to enter small tubular passages. To enter Morph Ball mode, press **B**. To return to normal mode, press **Y** a second time. Whenever Samus enters Morph Ball mode, the camera will shift to an external view to make it easier for you to navigate. The Morph Ball moves exactly as you would expect: like a rolling ball. Gravity will effect the ball, so rolling uphill is difficult and going downhill is a snap.

Morph Ball Bombs



Once you find the Morph Ball Bomb power-up, you'll be able to drop powerful bombs by pressing **Ⓐ** while in Morph Ball mode. These explosive devices can be used to damage enemies, destroy Sandstone and Talloric Alloy structures, and to propel the Morph Ball into the air, otherwise known as a Bomb Jump.

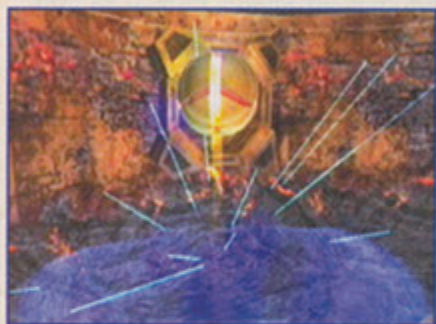

To perform a Bomb Jump, drop a Morph Ball Bomb and sit on top of it. When the bomb explodes, the Morph Ball will be propelled a short distance into the air. This is the only way to get into small tunnels or devices that sit above the ground.

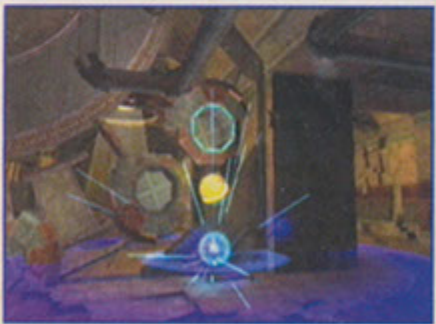

You can also perform a Double Bomb Jump to increase the height of your jump. This timing is tricky, but with a little

practice, you'll look like a pro. Begin by dropping a bomb on the ground and sit over it. Just before the bomb explodes, drop a second bomb. You'll be propelled into the air. Quickly place a third bomb in the air, which will remain in the air until it explodes. As you fall, the second bomb will explode and knock you back into the air. If your timing was just right, the third bomb should explode as the Morph Ball nears it, propelling the ball even higher into the air. The real trick is to drop the third bomb quickly after the second. If you wait too long, the bomb will be too high and will explode too soon.

NOTE

You can perform a Double Bomb Jump in water, but the technique is very different. In water you'll get a lot more height from your jump and you'll sink slowly. Therefore, dropping a second Morph Ball Bomb before jumping is pointless. Wait until the first bomb propels you into the air, then place a second bomb as your ascent begins to slow and not at the height of your jump. With proper timing, you'll be blown much higher. Get the technique down, and the only limit to how high you can go is the depth of the water.

Boost Ball



The Boost Ball power-up gives you the option of dashing while in Morph Ball mode. Press and hold **Ⓒ** to charge a speed boost. The longer you hold **Ⓒ**, the longer and faster the boost will be to a predetermined maximum. Scattered here and there throughout the world you'll find U-shaped areas known as half pipes. Using the Boost Ball, you can roll back and forth, gaining

height with each pass. Boost up one side, then quickly begin charging another boost as you roll back toward the bottom. Just before going up the opposite side, use another boost, and you'll go higher than before. Keep going back and forth, and your height will increase with each pass. This is extremely useful when trying to reach high places.

Power Bombs



Morph Ball Bombs may be powerful weapons, but Power Bombs are much stronger. Once you find the Power Bomb upgrade, you'll be able to drop Power Bombs by pressing **Ⓐ** while in Morph Ball mode. Unlike Morph Ball Bombs, you have a limited supply of Power Bombs, although you can get more by collecting power-ups dropped by defeated enemies. Power Bombs are great for destroying powerful enemies and especially for destroying Bendeziium and other strong structures. You cannot use Power Bombs to perform a Bomb Jump.

Spider Ball



Scattered around the world you'll find yellow and black magnetic rails that run up walls, across ceiling, and even around pillars. Once you have the Spider Ball upgrade, you can attach to such rails by holding **Ⓔ**. While attached to a magnetic rail, you can roll along without fear of falling unless you're shot by or come in contact with an enemy. Use the Spider Ball to reach otherwise unreachable areas.



Power Moves

Beyond her weapons, some of Samus's most important upgrades are those that increase her abilities. As she gains these powers, she'll be able to travel farther into the world and reach areas that are normally inaccessible.

Space Jump Boots



This upgrade allows Samus to leap to new heights. The Space Jump Boots make it possible for Samus to perform a double jump. Jump by pressing **Ⓒ**, then make a second leap by pressing **Ⓒ** again. The double jump allows you to leap over large gaps and up high steps.

Grapple Beam



The Grapple Beam is used to swing on Grapple Points as if on a rope. This makes it possible for Samus to swing over huge gaps and toxic substances safely. Grapple Points come in several shapes and sizes, but most have an orange color. Scan objects near the ceiling when looking for a Grapple Point. There's even one creature (Gliders) to which you can attach the Grapple Beam.

Using the Grapple Beam can be tricky. When you see an object to which you can attach, move around until the target icon grows and turns white. This means the target is in range. If you're too close or too far, you won't be able to latch onto the object. In cases where you're trying to latch onto a moving object, you'll need to time your grapple very carefully. It takes a moment for the beam to extend, attach, and grow taught. In that time, the targeted object will continue to move. Therefore, you must attach to the target before it moves into the proper position.



Power-Ups

In addition to the primary upgrades that increase Samus's abilities, there are other power-ups that increase her Energy and ammunition supplies. These are some of the most valued items available, but they're also well hidden. Finding them all will require a lot of exploration and some ingenuity on your part. None of these power-ups is required to finish the game, but finding them all will make the game much easier.

Energy Tanks



These are perhaps the most valuable of all power-ups. Each Energy Tank increases Samus's maximum Energy reserves by 100 points. The more you find, the more damage you'll be able to sustain in combat. If you find no other power-ups, be sure to collect every Energy Tank, and you'll have a much easier time getting through the game.

Missile Expansions



Your Missile Launcher has a limited supply of ammunition. At the beginning of the game, you'll be able to carry only five missiles at a time. As you find Missile Expansions, you'll increase your maximum capacity by five with each of these power-ups you collect. There are more Missile Expansions than any other power-up hidden throughout the game, so expect to find them regularly.

Power Bomb Expansions







When you get the Power Bomb upgrade, you'll be able to hold only four Power Bombs at a time. Power Bomb Expansions increase your maximum capacity by one. Several of these power-ups are hidden throughout the world, but you won't find any of them until you have access to Power Bombs.



Missile Combos



Beam weapons can be upgraded by finding combos. There are four combos hidden within the game for the four main beam weapons:

-  **Power Beam**
-  **Wave Beam**
-  **Ice Beam**
-  **Plasma Beam**

Missile combos combine a powerful blast from the beam weapons with a shot from the Missile Launcher. First you must charge the weapon by holding **(A)**, then press **(Y)** to launch the attack. It costs five missiles to use a combo attack. Some combos are single shot and others are sustained. With sustained-fire combos, the weapon will continue to fire until you release **(A)**. With sustained fire, it costs 10 missiles to engage the attack and five missiles for every second the attack is sustained.

Samus's Databanks



You'll gather a large amount of information as you play. If you press **(START)** while exploring, you'll gain access to Samus's Inventory screen. This lists all the items you've collected and provides useful information about each. In addition, you can press **(R)** to view the Log Book. This is a warehouse of knowledge taken from items, enemies, and objects you've scanned throughout your adventure.

Pirate Data

The Space Pirates are technological wizards. Their research into the world of Tallon IV and the effects of Phazon on native life-forms is well documented. As you search through their ships and research labs, you'll find detailed logs recounting the high and low points in their ruthless ravaging of the planet. Look for these tidbits on computer monitors in areas populated by Space Pirate forces.

Chozo Lore

Though the Chozo race may be little more than a memory, they've left behind a great deal of information about their society and lore. You'll find these useful stories scattered about, but primarily within the Chozo Ruins. Look for Chozo runes scribed into the solid rock walls of their ancient city. Fragments of Chozo Lore are always covered by a seemingly fluid substance that causes them to ripple. Once you've read a piece of Lore, the liquid effect vanishes.

Creature Data

As you battle, you can learn more about your foes by scanning them with the Scan Visor. Scans often provide extremely useful information on your enemy's strengths and weaknesses. You should always scan a new enemy before engaging it in battle. Remember that you'll face most bosses only once, so be sure to scan them immediately, or you'll miss your chance.

Research

You can learn more about the world around you by scanning objects such as power-ups, Save Stations, doors, and so on. Scanning gives you additional information about these objects, which you may find useful if you're unsure about what you should be doing. These are the toughest bits of Log Book data to collect, because they aren't clearly marked like Pirate Data and Chozo Lore. Scan everything if you want to locate every last bit of research data.

Artifacts



Your primary goal is to locate the 12 Artifacts left by the Chozo, which will allow you to gain access to the final battles and remove the plague of Metroids from the face of Tallon IV. The Chozo people have hidden the Artifacts well, but they've left clues to assist the protector of legend in finding them all. As you find these clues, they'll be added to this section of your Log Book. Once you find the Artifacts, the clues are erased and the Artifact is shown as collected.

NOTE

The Log Book is far more important than you might think. Should you collect all of the possible data, you'll be treated to two galleries of *Metroid Prime* artwork. The first gallery opens after you've found 50 percent of the Log Book information. The second is unlocked when you've found it all. Remember to scan everything and look everywhere if you want to find it all.

ADVENTURING IN TALLON IV

Metroid Prime is a very unusual style of game. It provides you with a great deal of freedom to explore on your own and encourages you to use your mind to discover its many secrets. The game's flow may be a bit confusing at first, but it's really quite simple to understand.

There are no "levels" in *Metroid Prime*. There is only one world with many different locations. The entire world is open to you from the first moment you enter the game, but you won't be able to explore it fully until Samus has grown in strength by collecting a variety of upgrades that are hidden throughout the world.

Some of the things that block your progress are locked doors, high ledges, toxic substances, and large chasms. Your different beam weapons and missiles are used to unlock these doors. It's possible to tell which weapon you'll need to use by the color of the door.

NOTE

The in-game map shows the color of the door only if you use **C** to select the area that it's in. The color of the doors in the map match the outline of the door when you walk up to it. The exception to this is the gray door; when you walk up to these, you encounter a Blast Shield covering the door. You must use a missile to destroy the Blast Shield, then use any beam weapon to open it.

Door Color	Weapon Required to Open
Blue	Any beam weapon
Gray	Missile
Purple	Wave Beam
White	Ice Beam
Red	Plasma Beam

Pits and toxic areas can be crossed only once you have the proper gear, such as a Grapple Beam, Space Jump Boots, or one of the many Power Suit upgrades.

As you progress, you'll find many passages that you can't enter or items that are inaccessible. Make a mental note of these locations, then come back and explore them at a later time.

Basically, what you'll do is explore until you find an upgrade. This will allow you to access a new area where you'll be able to find the next major upgrade. This pattern continues until the very end of the game. Along the way, the game will provide you with clues to help point you in the right direction. These clues don't take into account all of the items you can find, so sometimes you should explore on your own before heading off to the suggested area.

Combat



Combat is fairly simple. When faced with an enemy, you'll normally use the Combat Visor. A targeting reticle in the center of the screen will drift to any enemy in front of you. You can lock on to the target by holding **L**. All of your shots will be directed at this enemy until you disengage the lock. This also allows you to strafe around the enemy, meaning that you will continue to face this opponent no matter which direction you go. Strafing makes it much easier to dodge your opponent's attacks while continuing to fire.

If you hold down **R**, you'll be able to move the targeting reticle freely. Use this when you need to pinpoint an enemy, or just to look around a room. In some cases you won't be able to lock on to an enemy, so using **R** to look and target freely becomes necessary.

Which weapon you use is often just as important. Most enemies have a weakness to one type of weapon, so using it will make the battle much easier. For instance, fire creatures such as those found in Magmoor Caverns are weak against cold attacks, so the Ice Beam is your best weapon, although you won't have it the first time you venture through the area. Machines are particularly weak against the Wave Beam's electrical impulses. Get to know each of your weapons and toy around with every new enemy to discover your favorite strategy. Everyone will have his or her own ideas.



Some enemies require special tactics or gear. For instance, some Space Pirates are equipped with cloaking technology. You can just barely see them normally, but with the aid of the Thermal Visor, you can see them quite clearly. You may also need to use the different visors to locate a weakness in your opponent, or to overcome a negative area condition such as darkness or deep fog.

Saving, Healing, and Restocking



Samus isn't immortal. She's extremely tough, but you should be prepared for the occasional mishap and defeat. You can save your game at Save Stations and at Samus's ship. The ship is always found in the center of the Tallon Overworld. Save Stations are located in various locations in each area.

Save often. Not only will it keep you from losing progress, but each time you save, your suit's Energy is completely restored. If you save at Samus's ship, your Energy and ammunition are both restored.

You can restore Samus's Energy and ammunition in the field by collecting power-ups that are dropped by defeated enemies. Missiles are restored five at a time, but you may also find Missile Stations that can completely refill her stock. Power Bombs are restored one at a time. Energy power-ups can restore 10, 20, or 100 points at a time. As your Energy reserves increase, the Energy power-ups you find become larger. So at the beginning of the game, you'll see only 10-point power-ups, but by the end, 100-point power-ups become almost common.

Space Pirate Frigate

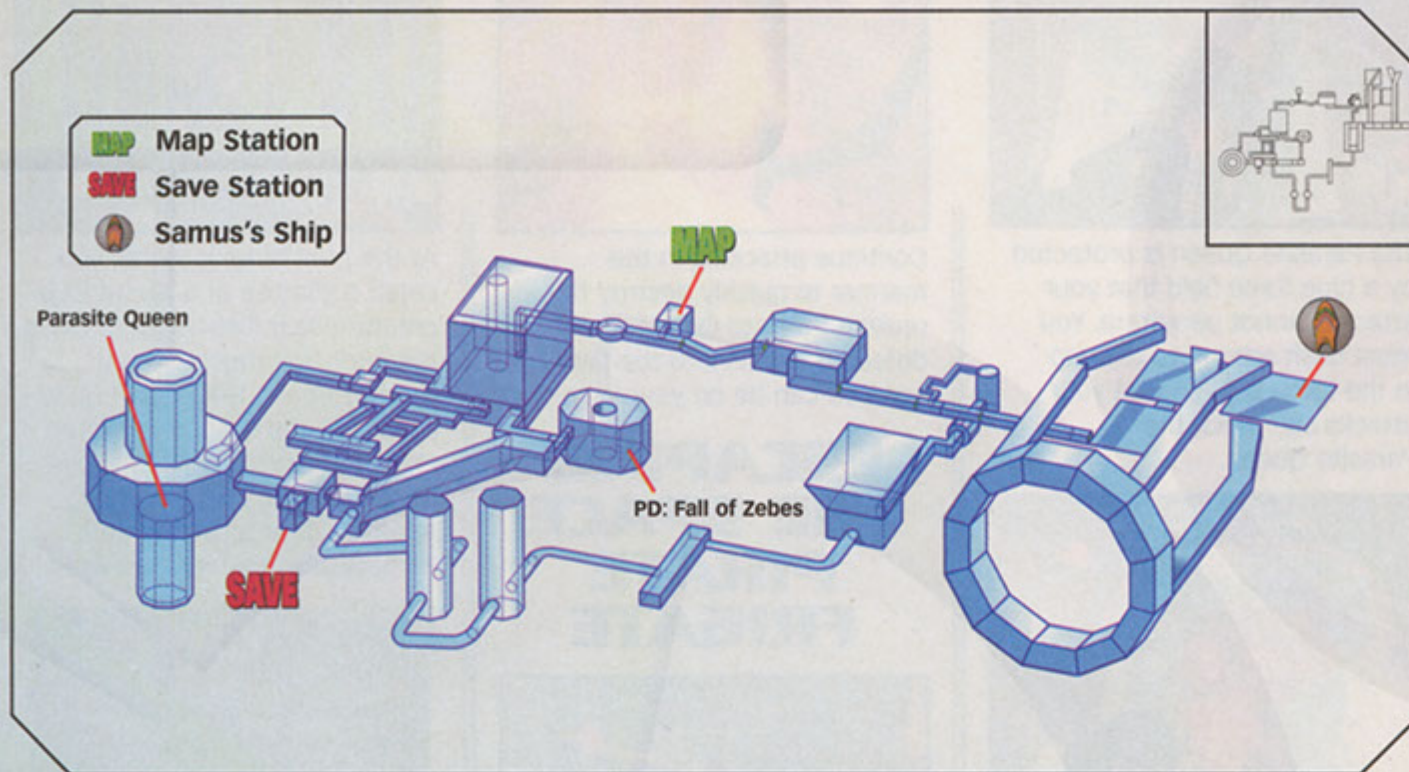

SPACE PIRATE FRIGATE MAP

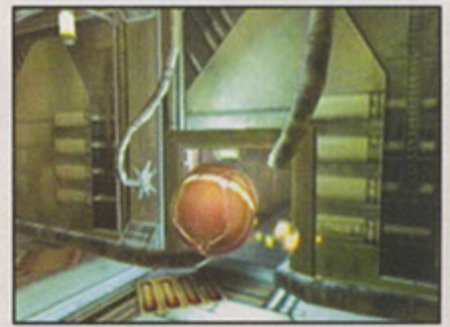

In the hallway just before the elevator, press **X** to morph into the Morph Ball and roll through the little hole on the right. In the room beyond is a Map Station where you can download the map for Space Pirate Frigate.



LEARNING THE ROPES



This badly damaged Space Pirate Frigate is your chance to become familiar with the controls. Pay close attention to your visor computer to learn the basics of your equipment and controls.



To get through the force field, press **A** to shoot at the four red buttons on either side. Hold down **L** to lock onto the buttons for an easier shot.

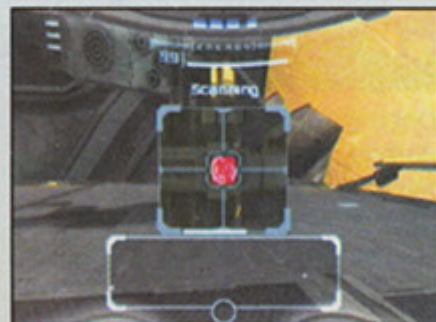

Before you can open the next force field, you must bring the force field controls online. Press **+** on the + Control Pad to switch to the visor. When Scan Visor mode is active, anything that can be scanned appears as a colored square. Hold down **L** to scan the selected object.



After you pass through the force field, shoot the door at the top of the ramp to open it. Make your way to the tunnel blocked by rubble. You can blast away the rubble by using the Charge Beam. Hold down **A** to charge it, and release to fire.

TIP

You will come across many dead or dying Space Pirates on this ship. The dying ones will occasionally shoot at you as you near them. Shoot them to avoid taking damage.



Parasites



Parasites aren't very dangerous unless they are swarming. When in tunnels, they swarm in a spiraling pattern and must be taken out as quickly as possible. A couple hits from these creatures isn't fatal, but a few hundred hits can be.

At the elevator, scan the switch to go down to the next area. After rolling through the tight spaces in Morph Ball form, you reach a large room. The injured Space Pirates are healthy enough to approach you but are still very slow. Use this opportunity to practice targeting and dodging the moving targets. With a Space Pirate locked on, tap **C** to dash left or right.



After you take out the Auto Defense Turret in the next hallway, you emerge in another large room with strange creatures suspended in liquid. Scan the computer panels here to access your first Pirate Data. Pirate Data can be found throughout the game and may shed some light on what happened to the Space Pirates.



NOTE

Scanning all of the Pirate Data isn't necessary to complete the game, but it is necessary to unlock some of the game secrets. Check chapter 5, "Items," to find the locations of all the Pirate Data.



Continue working your way through the next several doors and elevators until you reach the first Save Station. Walk into the hologram to save your game and replenish your Energy for the upcoming boss battle.

BOSS BATTLE: PARASITE QUEEN



When fighting any boss in *Metroid Prime* the first step is to scan the enemy. Scan every enemy you encounter, especially the bosses. The scan usually reveals useful information about the opponent and hints at its weaknesses.

NOTE

If you do not scan the Parasite Queen, you will not be able to lock onto its weak spot: the mouth. Without a scan, your auto-target locks onto the body, and your attacks are less effective.



The Parasite Queen is protected by a blue force field that your attacks cannot penetrate. You must dash around to the gap in the force field so that your attacks can reach the Parasite Queen.



Use any missiles you have, and also hit it with your Charge Beam. The bar at the top of the screen indicates the Parasite Queen's energy.



During the fight, hold down **L** to keep the Queen targeted. This also allows you to quickly dash out of the way of its attack by pressing **○**.



When the force field spins around the Parasite Queen, fire as many regular Power Beam attacks as possible. Your Power Beam is quick enough that a few shots can penetrate the shield.



Continue attacking in this manner to quickly destroy the mutant Parasite Queen. Once defeated, it falls into the fiery pit, and you can be on your way.

ESCAPING THE SPACE PIRATE FRIGATE



Once the Parasite Queen is defeated, you have only seven minutes before the ship is destroyed. You can't leave the way you came so make your way out the other door.



Through the next few tunnels, you are attacked by several swarms of Parasites. Shoot them as quickly as you can; time is of the essence.

CAUTION

That many Parasites can stain your visor and render you sightless for a moment if they blow up in your face. Take a second to get your bearings again so that you don't end up going the wrong way.



At the pool of toxic water, you catch a glimpse of a mysterious creature as it flies away. To cross the pool, you must use your Grapple Beam. Hold down **L** to shoot out the Grapple and grab on to the Grapple Points above. At the far side of your swing, release **L** for a second and immediately hold it down again.

TIP

Scan all of the switches that you see along the way. There are Auto Defense Turrets that you can turn off by switches. Those switches can be a lifesaver if you are out of missiles from fighting the Parasite Queen.



You make it out just in time to see the flying creature take off and as the Space Pirate Frigate explodes. Close call, but you made it. It's time to check out the planet of Tallon IV.

Phendrana Drifts

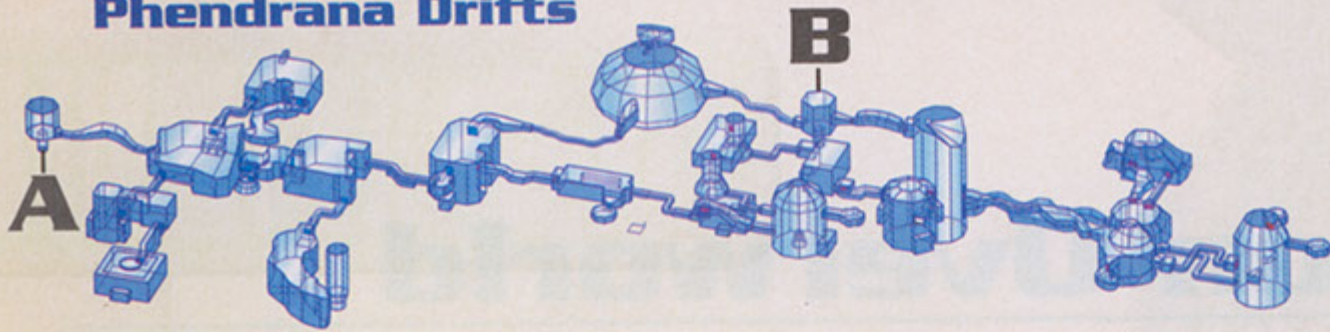

NOTE
All the worlds of *Metroid Prime* interconnect. Matching letters indicate elevators or portals between the worlds.

Magmoor Caverns



Chozo Ruins

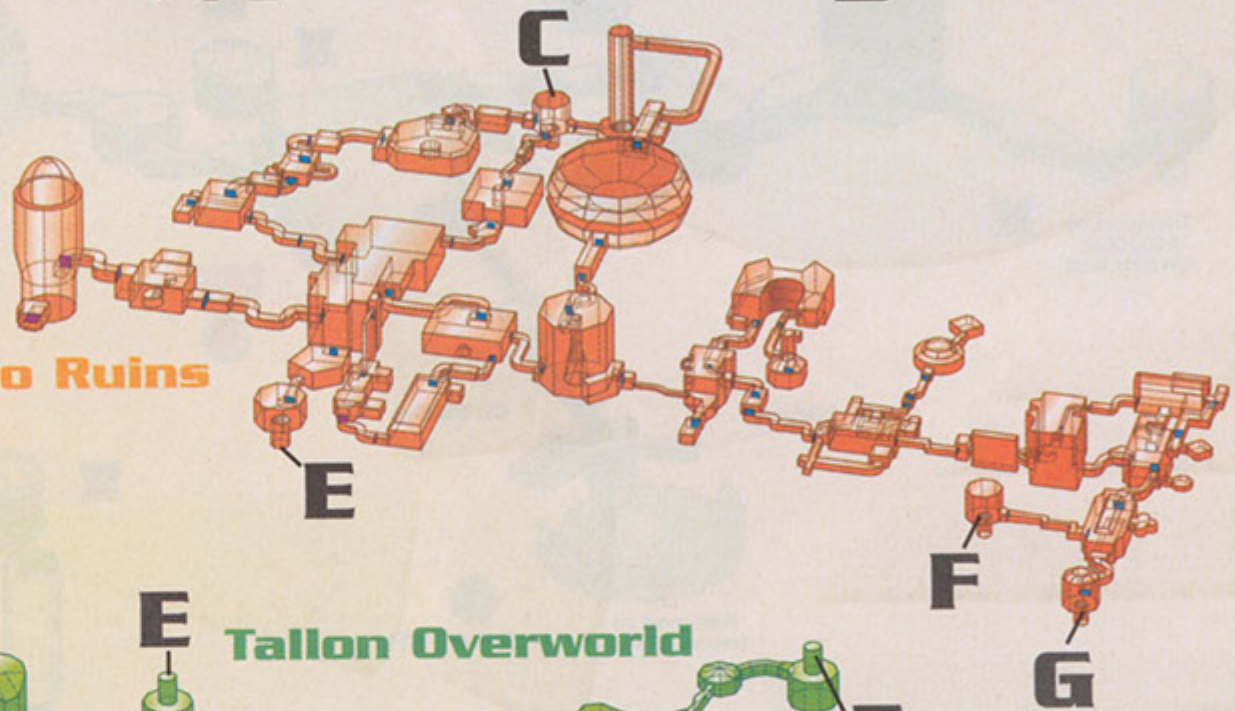

Tallon Overworld

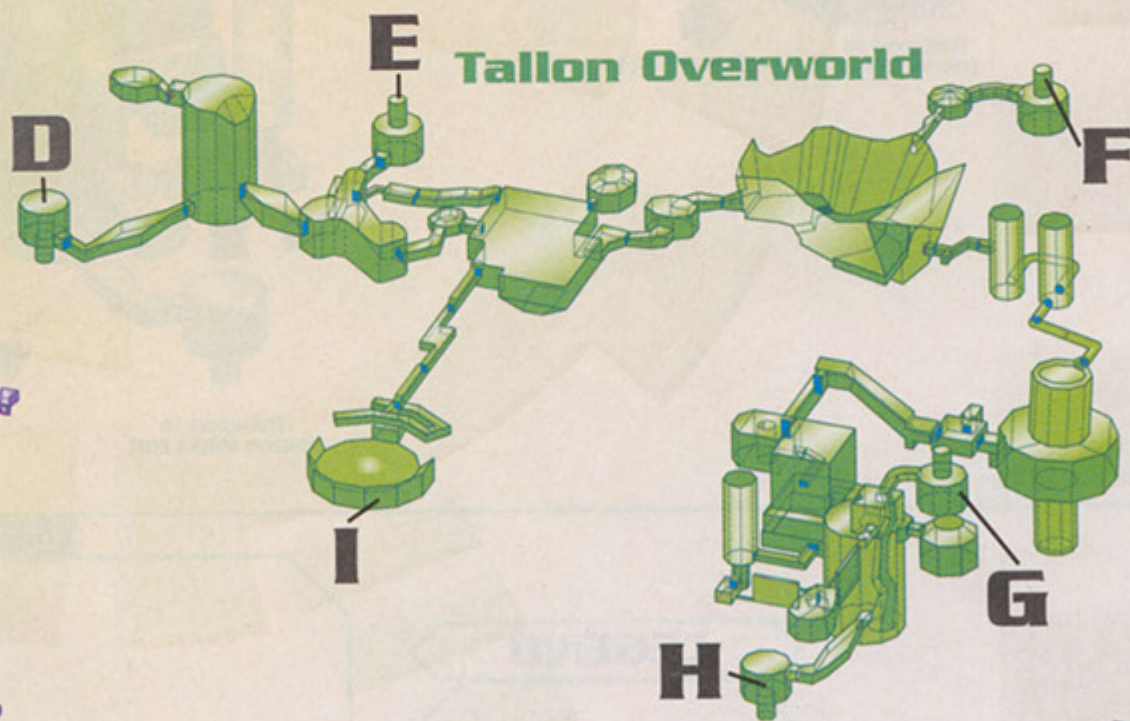

Phazon Mines

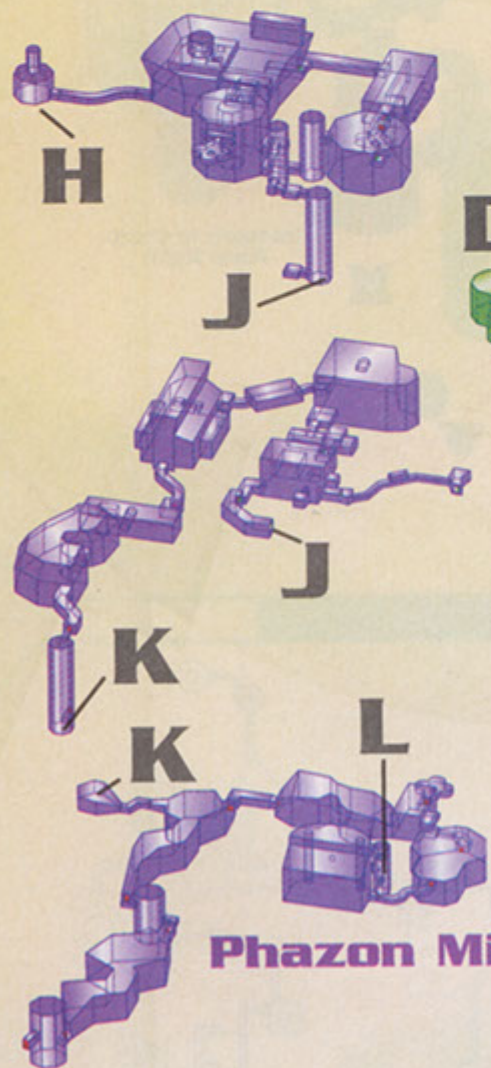

Impact Crater

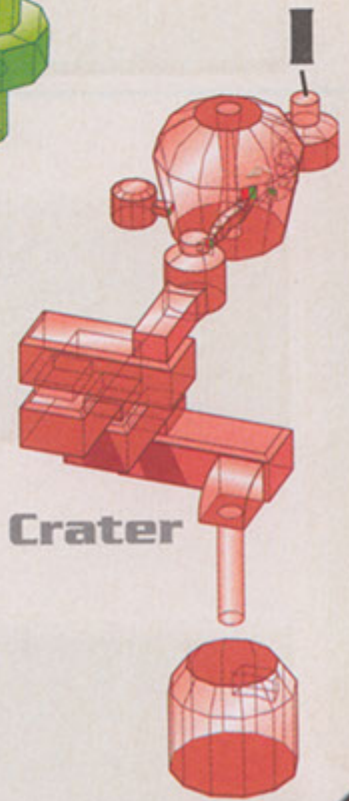

Tallon Overworld

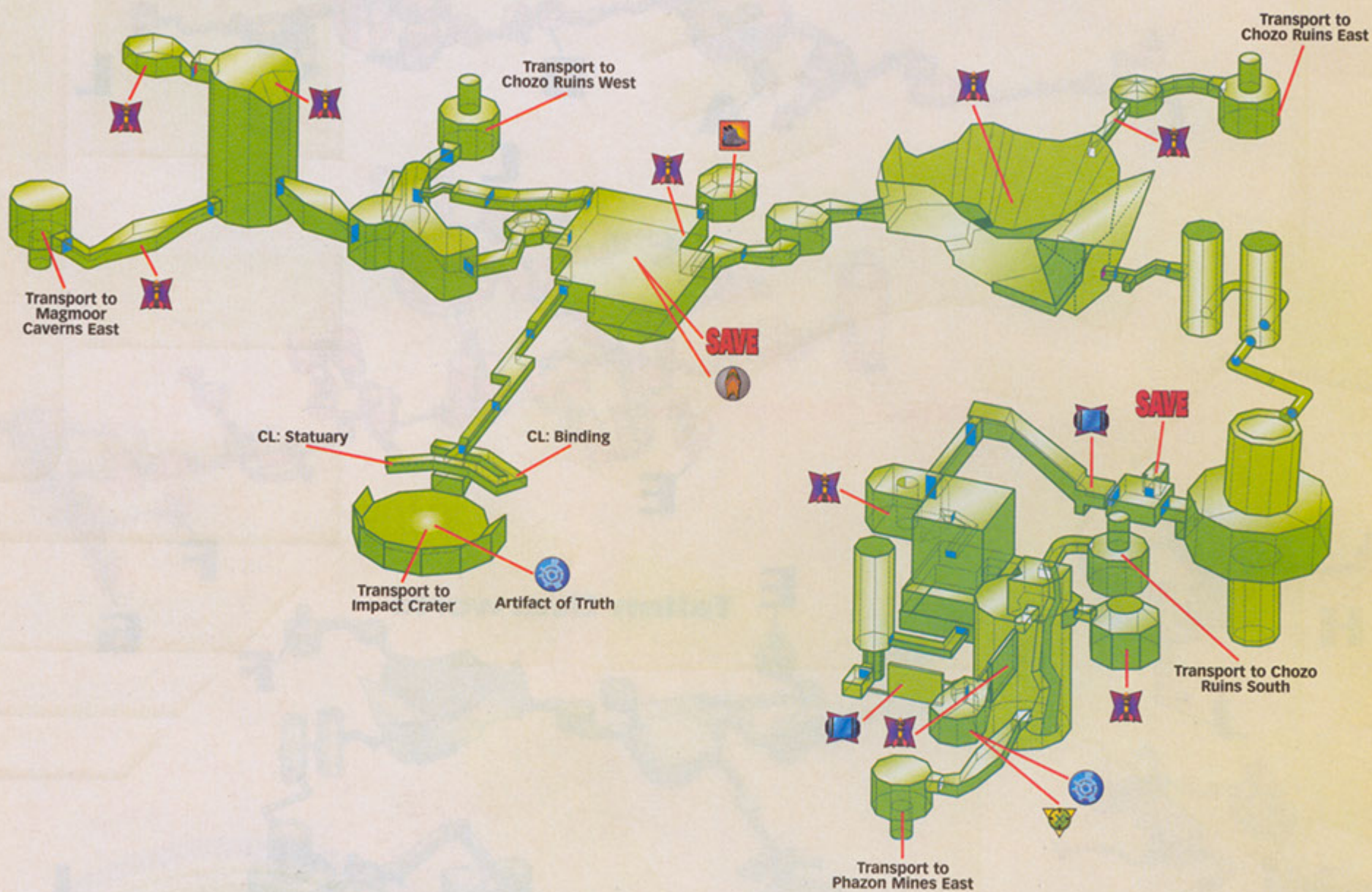

LEGEND

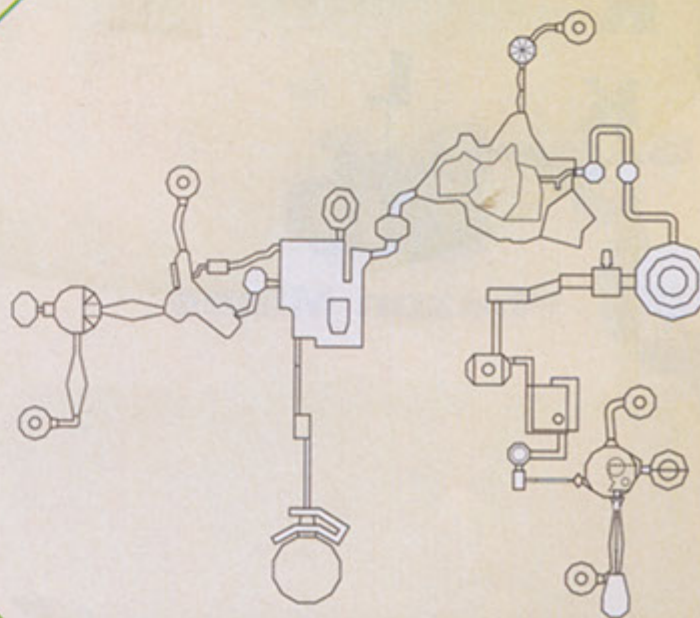

- Save Station
- Samus's Ship
- Artifact of Chozo
- Missile Expansion
- Energy Tank
- Space Jump Boots
- X-Ray Visor

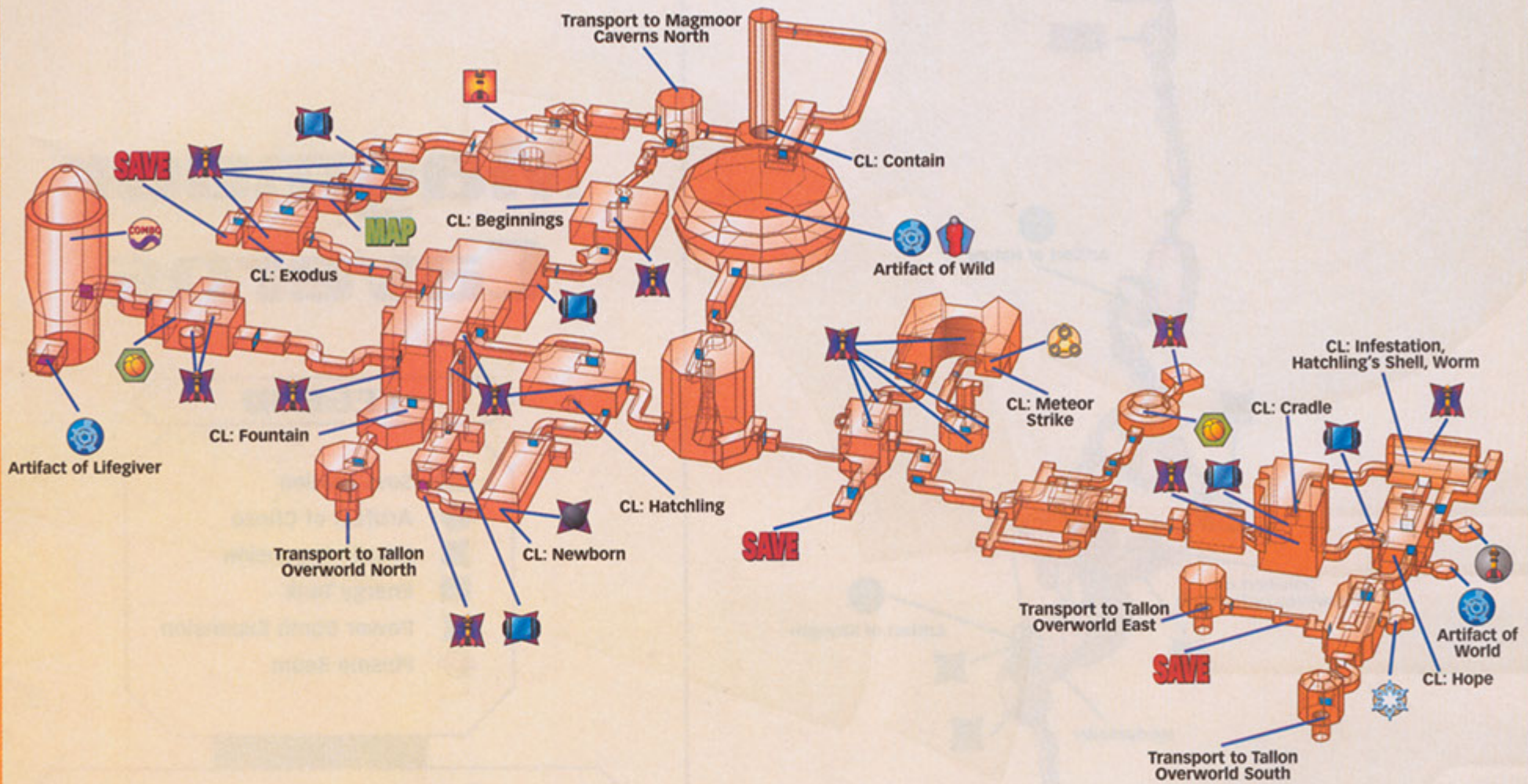

Chozo Ruins



LEGEND

-  Map Station
-  Save Station
-  Missile Recharge Station
-  Artifact of Chozo
-  Missile Expansion
-  Missile Launcher
-  Energy Tank
-  Power Bomb Expansion
-  Wave Beam Combo
-  Ice Beam
-  Charge Beam
-  Morph Ball
-  Varia Suit

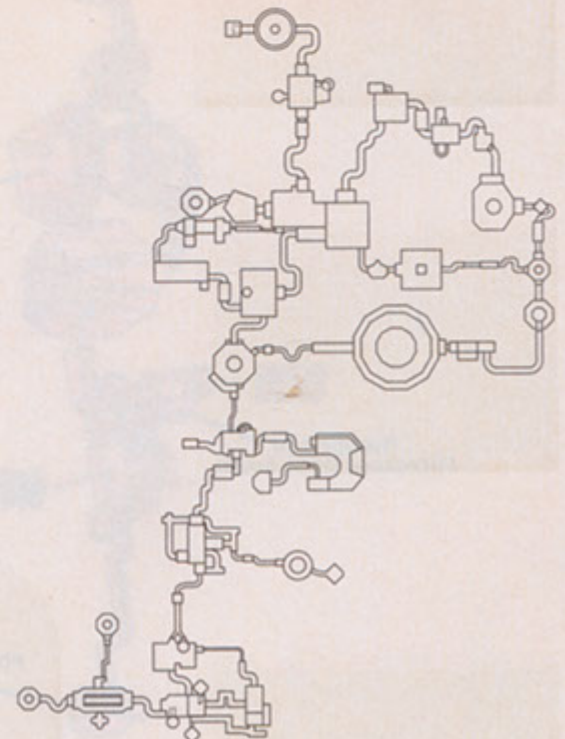

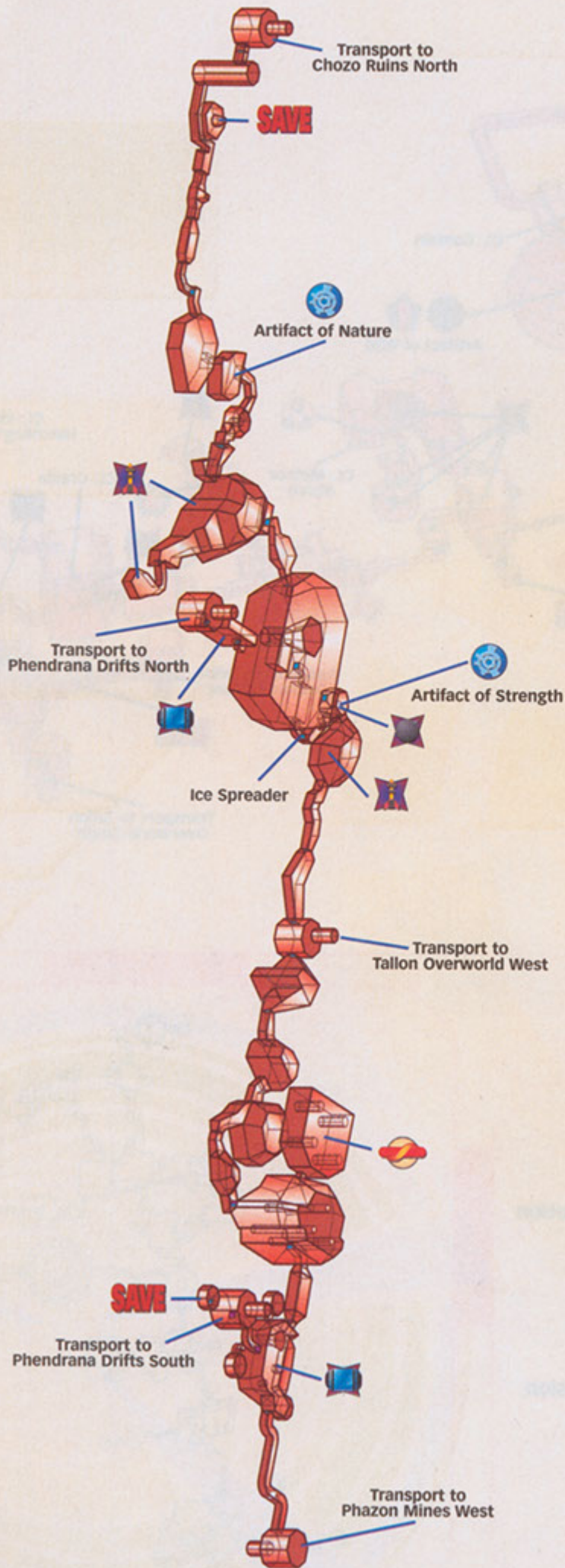

Magmoor Caverns





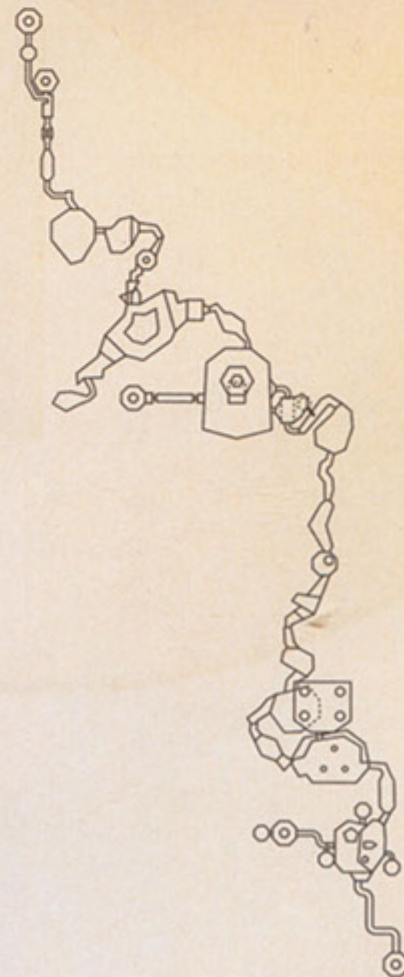





LEGEND

- Save Station
- Artifact of Chozo
- Missile Expansion
- Energy Tank
- Power Bomb Expansion
- Plasma Beam



Phendrana Drifts





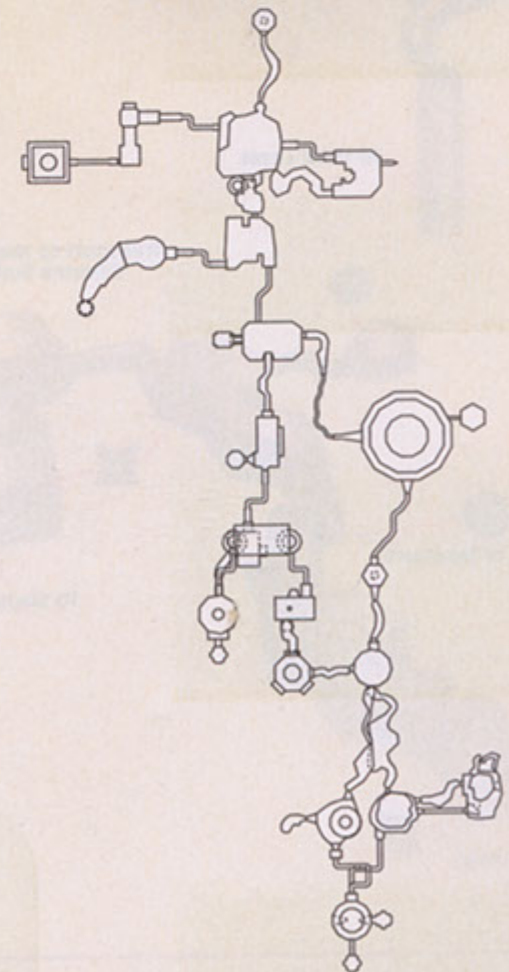
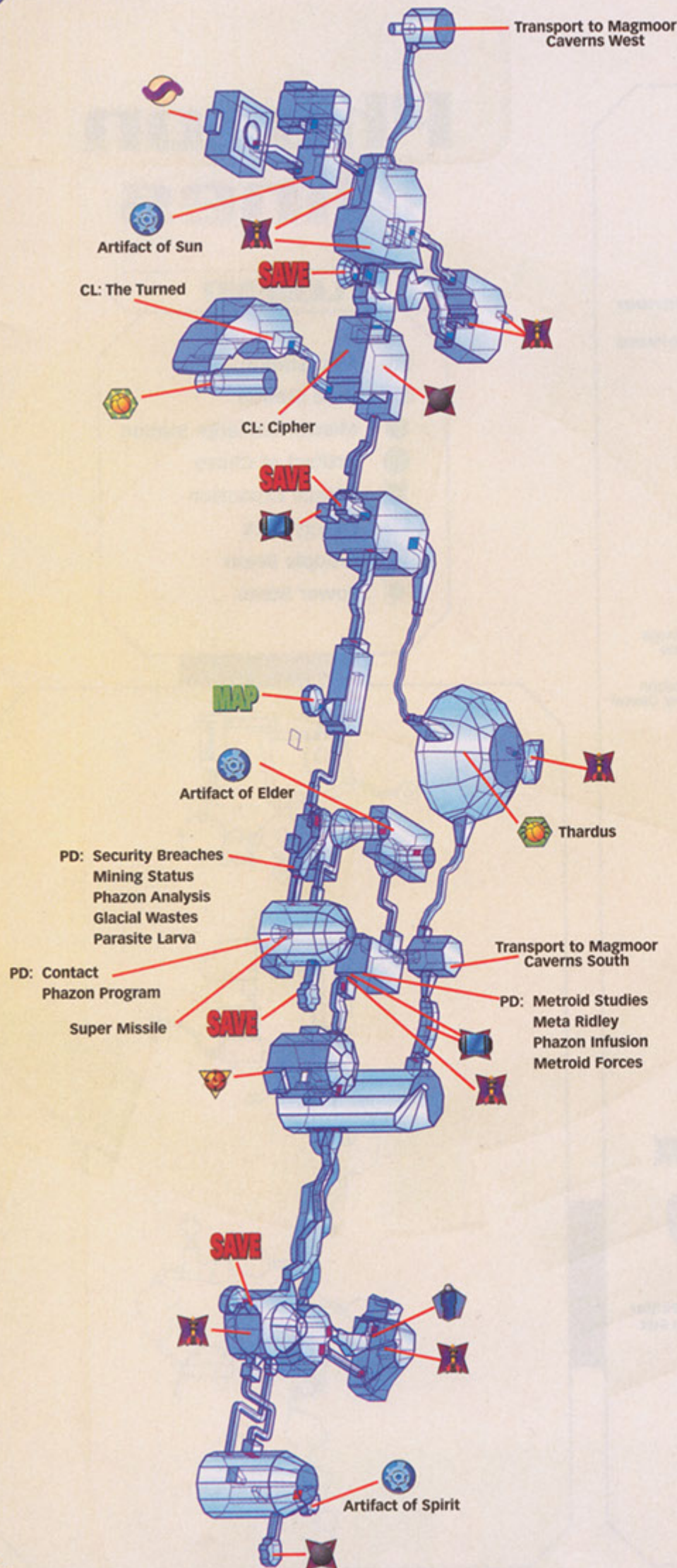



LEGEND

-  Map Station
-  Save Station
-  Artifact of Chozo
-  Missile Expansion
-  Energy Tank
-  Power Bomb Expansion
-  Wave Beam
-  Boost Ball
-  Spider Ball
-  Gravity Suit
-  Thermal Vision



Phazon Mines

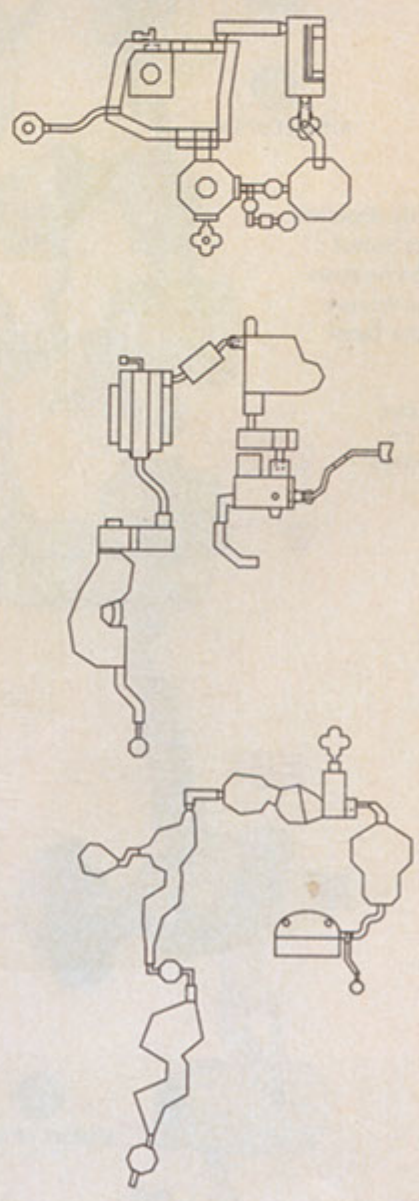
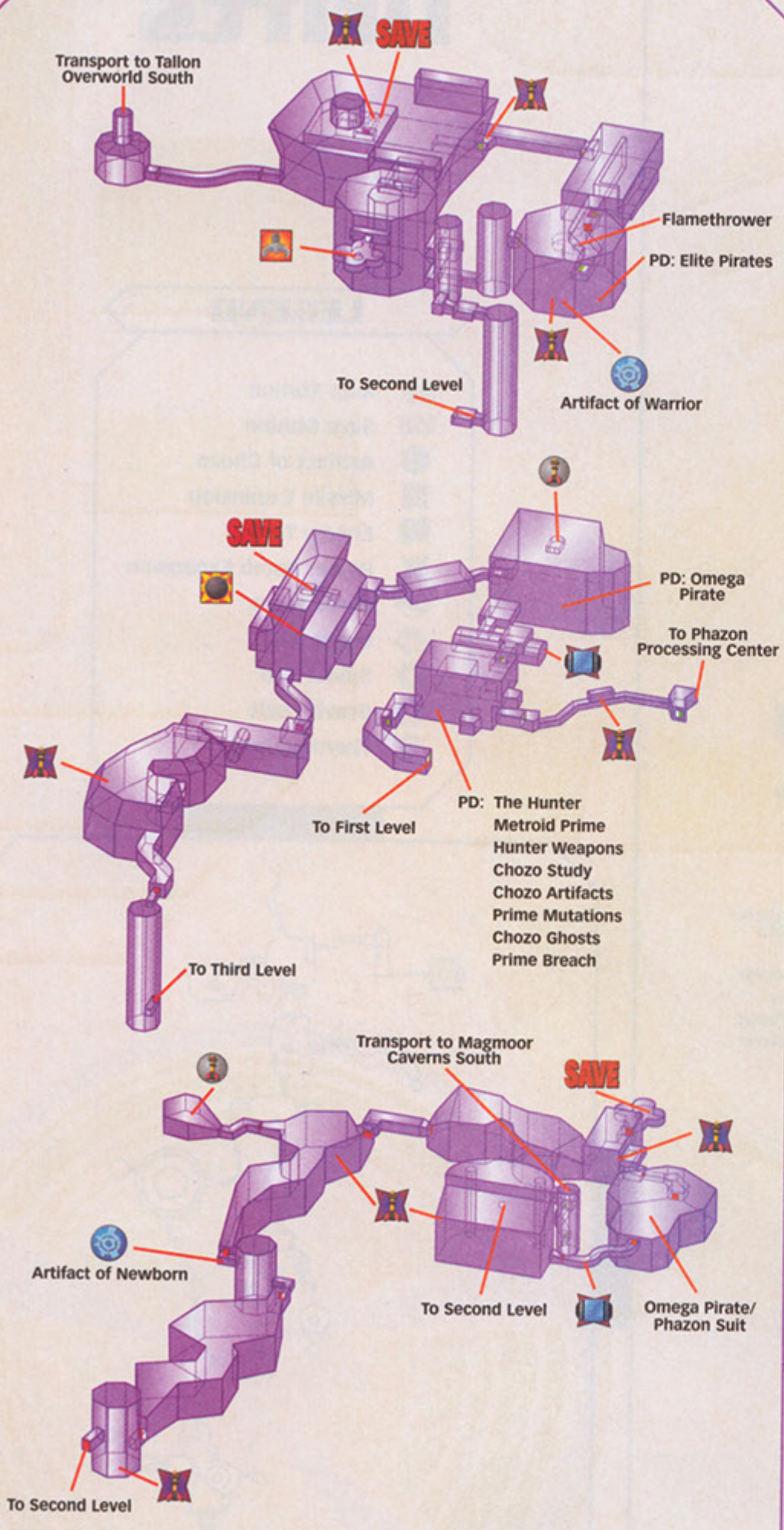

LEGEND

-  Map Station
-  Save Station
-  Missile Recharge Station
-  Artifact of Chozo
-  Missile Expansion
-  Energy Tank
-  Grapple Beam
-  Power Bomb



Impact Crater

LEGEND

-  Save Station
-  Missile Recharge Station

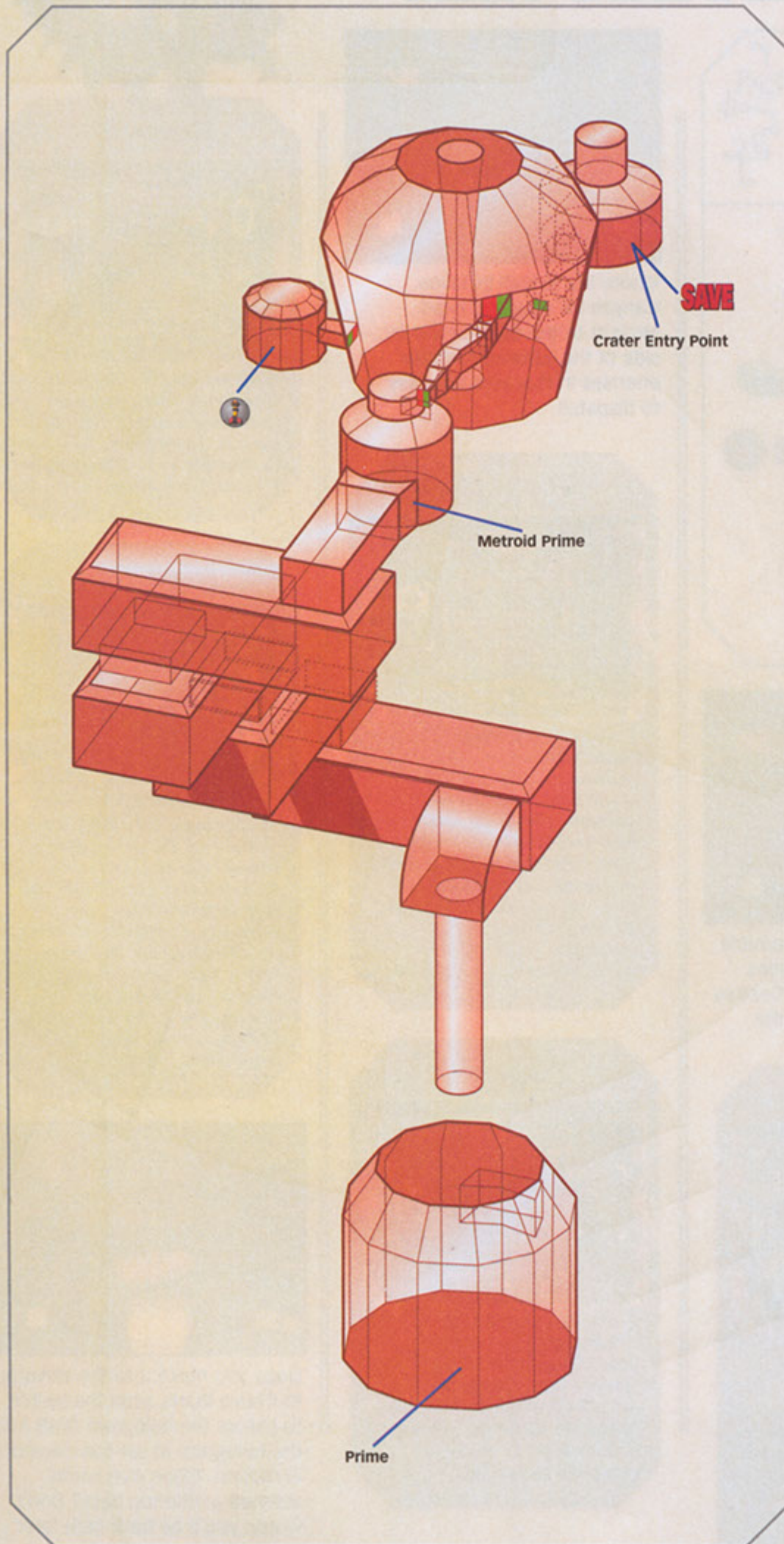
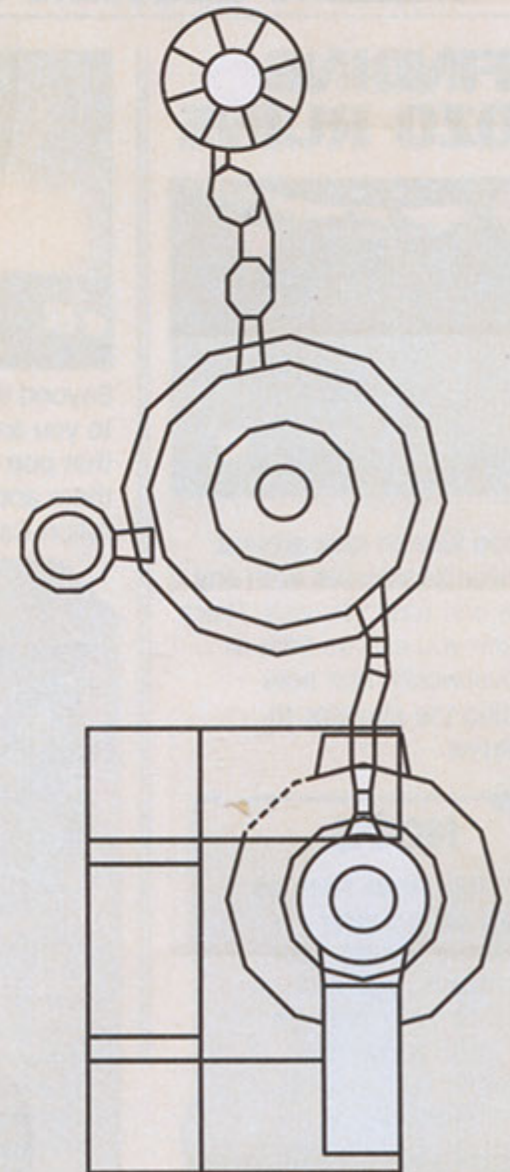

Tallon Overworld First Visit

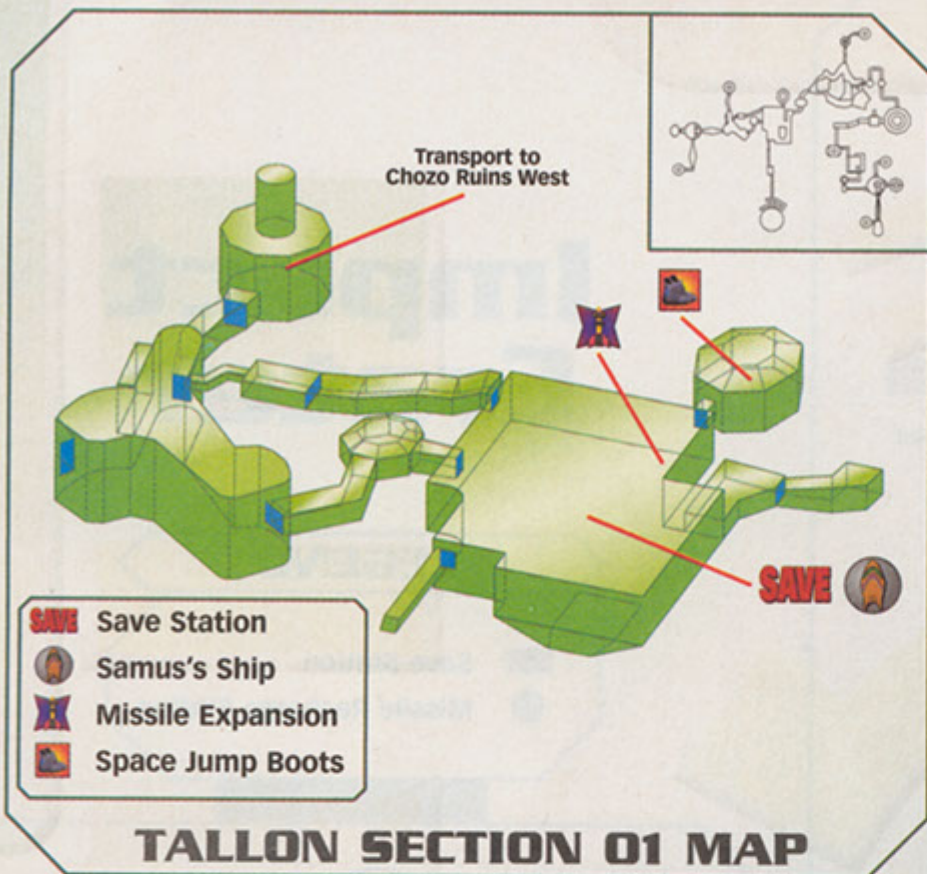

FINDING CHOZO RUINS



It's a good idea to look around and familiarize yourself with any area the first time you visit. There isn't much you can do here in Tallon Overworld right now except find the elevator to Chozo Ruins.

NOTE

Your ship stays here as you go off on your adventure. Along your adventures, you can return to your ship to save your game and replenish your Energy and weapons.



Beyond the only door accessible to you are a bunch of Beetles that pop out of the sand. Destroy them and continue on to the Tallon Canyon.

Beetle

Beetles pop suddenly out of the ground. They are easy to destroy with a few shots from your Power Beam. They like to strafe back and forth before charging at you. Keep a lock on them by holding down [L] and fire repeatedly. If there are more than one, continue to switch targets to ensure that you destroy the nearest ones first.

Beetle

[[Log Book]]

Biology: Beetle

Behavior: Beetle

Behavior: Beetle

Behavior: Beetle



Ignore the ledges in Tallon Canyon for now and head straight to the door on the far side of the canyon. The few enemies in this area are easy to dispatch.

Blastcap

These overgrown mushrooms are a nuisance more than anything. Touching them causes them to explode and release a noxious gas that lasts for a few seconds after they are destroyed. Blast away at them from a distance with any weapon of your choice.

Blastcap

[[Log Book]]

Species: Blastcap

Behavior: Blastcap

Behavior: Blastcap

Behavior: Blastcap

Zoomer

Zoomers are spiky creatures that crawl on the sides of rocks. Their spikes are dangerous, so don't step on them. You can destroy these critters with any weapon you like.

Zoomer

[[Log Book]]

Biology: Zoomer

Behavior: Zoomer

Behavior: Zoomer

Behavior: Zoomer



Geemer

Similar to the Zoomer, Geemers have spikes that are harmful to the touch. Geemers, however, are vulnerable to only missiles.

Geemer

[[Log Book]]

Biology: Geemer

Behavior: Geemer

Behavior: Geemer

Behavior: Geemer

Sap Sac

The amber-colored Sap Sacs are found under branches and attached to tree trunks. They are not aggressive, but explode violently if shot at. Keep your distance from Sap Sacs if you decide to shoot at them. Its explosion will damage any nearby enemies.

Sap Sac

[[Log Book]]

Species: Sap Sac

Behavior: Sap Sac

Behavior: Sap Sac

Behavior: Sap Sac



Once you make it to the elevator to Chozo Ruins, scan the switch to call up the hologram. Walk into the hologram to set the elevator in motion. Tallon Overworld seemed a little too easy? Don't worry; you'll be back here later.

Chozo Ruins First Visit

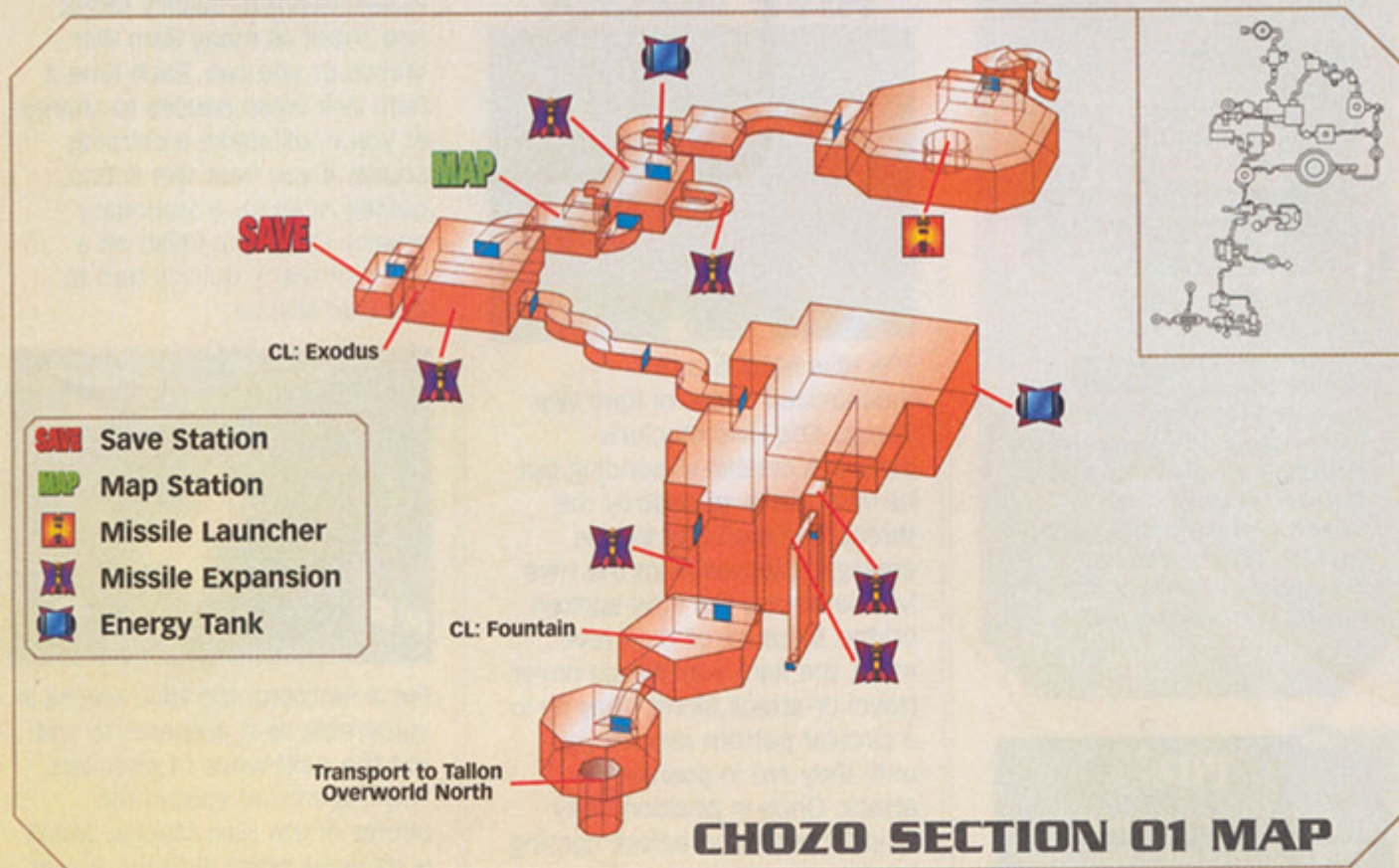

Eyon

Eyon

These one-eyed baddies shoot lethal laser beams that slice through Samus's armor. Fortunately, a bright flash from your Power Beam causes them to temporarily shut their eye and gives you a chance to dart through. Once you get the Charge Beam, you'll be able to destroy them.



THE MISSILE LAUNCHER



As you enter the ruins, you receive a message saying that abnormal seismic activity has been detected nearby. Press [Z] to call up the map that shows the source of the disturbance.



There isn't much to the ruins entrance except for a couple Beetles and your first Chozo Lore, Fountain. Start your Chozo Lore collection by using your Scan Visor to scan the rippling area above the door. Switch to your Scan Visor often throughout your adventure so that you don't miss anything.

NOTE

The ancient race of Chozo left behind 16 fragments of their lore. The 16 Chozo Lore may guide Samus in her adventure as well as provide glimpses into their civilization. Rippling walls indicate a Chozo Lore. Scanning all of them will help you fill your log book, which will also help you unlock some of the secrets in the game.



As you enter the Main Plaza, beware of the ambushing Beetles in the inconspicuous sand. Go up the stairs and through the door on the left toward the Ruined Nursery. Be ready for some resistance in the tunnels that follow.

Scarabs



These critters like to swarm in tight corridors and cling along the walls. They're easy to exterminate, but keep your distance. Their sheer numbers and explosive nature can overwhelm an unprepared Samus. For now, use your Power Beam to take them out, but once you have the Morph Ball power, you can roll right by without taking much damage from them before they settle.

In the Ruined Nursery, fight off the Beetles, and the War Wasps coming out of their hives. Bypass the exposed door and instead hop to the little ledge leading to an alcove. The door in the alcove leads to the first Save Station in Chozo Ruins.

War Wasps

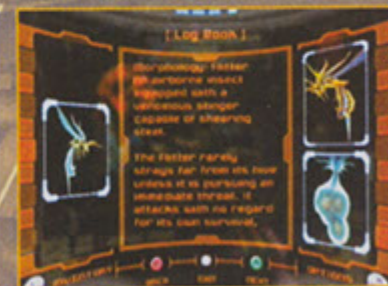

These dangerous insects are very protective of their hives. If you get too close for their comfort, which can be quite far, they come out of the hives to attack with their poisonous stingers. Use your Power Beam to quickly destroy them. War Wasps will continue coming out of their hives until the hive is destroyed. You can't destroy the hives right now because doing so requires the Missile Launcher.



TIP

Save Stations are very important. Even if you don't wish to save, return to any nearby Save Station to replenish your Energy.



After saving, continue making your way to Hive Totem. Along the way, you meet a few new creatures. Remember to scan all of them the first time you see each one to ensure that you fill your Log Book.

Plazmite



Plazmites look like a cross between a flea and a firefly. They are slow moving and easy to snuff out. Don't waste any of your limited ammo; a couple of Power Beam shots will take care of them. Plazmites provide light, which is valuable in some areas. You may not always want to eliminate them.



Tangle Weed



Tangle Weed isn't dangerous; it's just a nuisance that slows down Samus. Shoot the Tangle Weed to retract them into the ground, which will allow you to travel through the patch unhindered. The Tangle Weed will reappear shortly; it can never be destroyed.

TIP

If you're low on Energy, shoot any crates you see. They often contain Energy or missiles.



When you enter Hive Totem, everything seems quiet. The slant of the room keeps at bay the toxic waters to the left. Avoid the waters on your way to the circular platform in the center of the room. Across the bridge is the Missile Launcher. Looks like a trap, doesn't it? Approaching the bridge sets off the mechanical device on the other side. The room fills with the dangerous water, trapping you on the platform just before the Ram War Wasps start to pour out.

BOSS BATTLE: HIVE MECHA



The Hive Mecha is the mechanized home of Ram War Wasps. The Hive Mecha's defenses consist of sending out its inhabitants to destroy the threat. The Ram War Wasps emerge in waves from the Hive Mecha across the now-sunken bridge. Because of their hive mind, the Ram War Wasps never travel or attack alone. They fly in a circular pattern around you until they are in position to attack. Once in position, they stop for a second before coming in and attacking together.



The best defense against these Ram War Wasps is to destroy them as fast as possible. During their fast circling, it's difficult to get a lock on them. You must turn with them while constantly shooting the Power Beam if you hope to tag a few while they're in motion. Hold down **R** while you turn so that you can adjust the height of your Power Beam. When a Ram War Wasp pops into view, pull on **L** to try to get a lock on one. Don't worry if you can't target any of them. Just keep shooting (while you rotate) at about the level they are flying until they get into their positions.

TIP

When the Ram War Wasps attack, they tend to knock you around a bit. Keep an eye on where you are standing on the platform after every wave of attack. Center yourself on the platform so that you don't get hurt by the water.

In the moment that they stop, make liberal use of **L** and your Power Beam to quickly target and shoot as many Ram War Wasps as you can. Each time a Ram War Wasp pauses to charge at you it will make a chirping sound. If you hear this sound, quickly scan for a stationary enemy. Once you finish off a wave of them, quickly turn to the Hive Mecha.



For a moment, the Hive Mecha is vulnerable as it prepares to spit out the next wave of attackers. You'll see a red spot in the center of the Hive Mecha, which is its weak point. Fire the Power Beam as rapidly as possible and watch the hive light up red as it takes damage. Deal as much damage to the hive as fast as you can. If you don't destroy the hive, the waves keep coming.

Repeat the same tactics for each subsequent wave of Ram War Wasps. Clear the Ram War Wasps and destroy their home. Your prize for defeating the Hive Mecha is a shiny new Missile Launcher.



Congratulations! Press **O** to fire your missiles. With the Missile Launcher, you now can open doors that are locked by a Blast Shield. On the maps, these doors are gray.

TIP

With your newly-acquired Missile Launcher, you can access the next room. The Energy Tank in this room refills your Energy reserves and adds to its capacity by 100.

THE MISSILE LAUNCHER

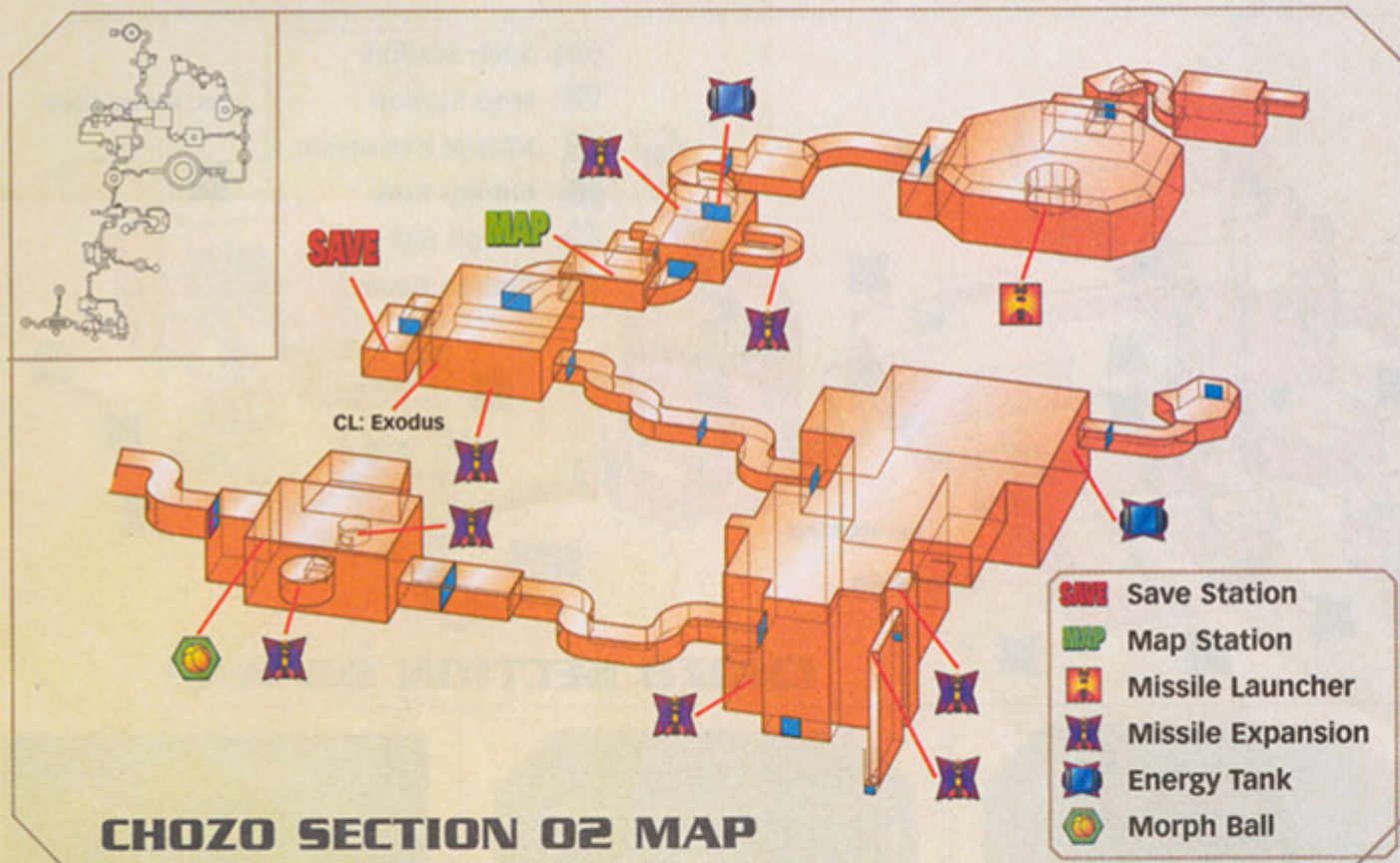

CHOZO SECTION 02 MAP

Beetle's front side is invulnerable to all of your weaponry. The only weak spot is its red back side. The challenge is to get into position so that the Plated Beetle's soft side is exposed.



Stand in one spot, leaving room to maneuver on either side. The Plated Beetle will look like it's charging you, but it will stop just short. Stand your ground as it starts strafing from side to side. When you see its vestigial wings begin to shimmer, dash out of the way to the side by holding down **[Left]** and tapping **[Fire]**.



You can now use your missiles to break the Blast Shield on the door in Ruined Gallery. The Map Station behind the door reveals the entire Chozo Ruins layout. Press **[Z]** to call up the map. Areas you've visited are colored orange, and the unexplored areas are blue.

CAUTION
 Don't forget to take a moment at the Save Station to save your progress. It would be a shame to have to repeat all of the hard work you've done since the last save.



Back in the Main Plaza, dodge or destroy the Beetles that pop out of the sand. Shoot the Blast Shield off the door and proceed to the Ruined Shrine. If you're low on health, recharge at the Save Station and come back. You won't get the Morph Ball without a fight.



The other item is hidden in the walls. Use your Scan Visor to check out all the readings. This spot here seems to have some stress points that a concussive blast might lodge free. The Missile Expansion behind it increases your Missile Launcher's capacity by five.



BOSS BATTLE: PLATED BEETLE



As you drop down into the pit, Beetles start popping out of the sand. Stay on your toes, because there are many. The trick here is to continue firing your Power Beam as fast as you can as you quickly tap **[Left]**. (Tapping **[Left]** retargets your aim so that you eliminate the nearest Beetles first.) While you're at it, don't forget to strafe, or you'll take damage from charging Beetles. Missiles are too slow.



The Plated Beetle appears after you've destroyed its little minions. Unlike the Beetles, the Plated



The Plated Beetle charges right by you and exposes its weak spot. Pepper it with your Power Beam while firing missiles at it. You will get only a few shots before it turns around again. No problem. Repeat the same strategy until its hind side is blown to bits.



After defeating the Plated Beetle, claim your Morph Ball. With it, you gain the ability to morph into a small ball and fit into tight places. Press **[Morph]** to turn into the ball and use **[Left]** to move around. The only exit is through the round hole in the wall.

THE CHARGE BEAM

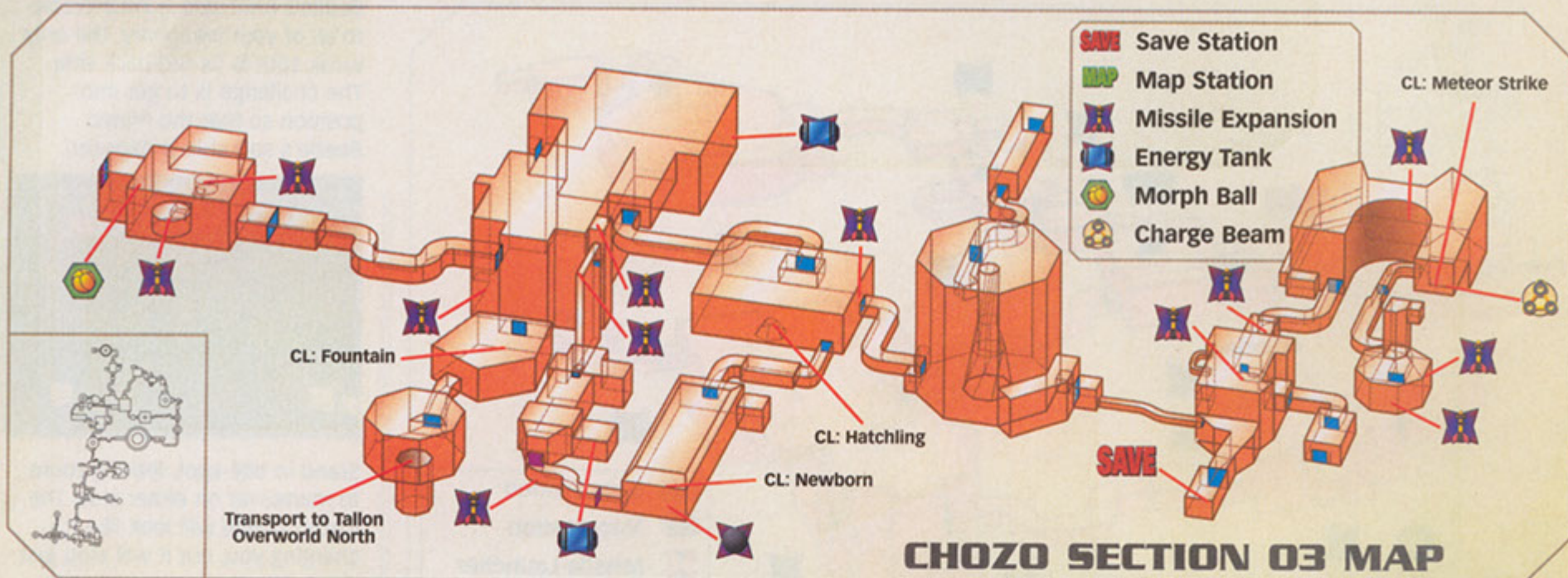

CHOZO SECTION 03 MAP



Return to the Main Plaza after saving your progress. Scale the rubble around the upper part of the Main Plaza to reach the tree bridge.



Once across the bridge and a few downed War Wasps later, go through the door and use the Morph Ball ability to squeeze through the tight spots.



When you reach the Ruined Fountain, shoot down the Plazmites and circle around the right side of the room. Ignore the first door for now and go through the second.

Shriekbat

[Log Book]

Morphology: Shriekbat
 Habitat: Chozo
 Color: Yellow, Red
 Body temperature: peaks at 125 Centigrade.

Shriekbats have high internal temperature, making them easy to spot with thermal imaging. They float on heat currents above hunting for small prey.

Shriekbats are aptly named for the sound they make when they attack. They usually hang upside down high on walls and charge you as you near them. Until you get the Thermal Visor you can't target Shriekbats while they are hanging. You must either manually target them or wait until they are airborne to fire at them. Once the Shriekbats begin their dive-bomb attack at you, they can't change course. The Power Beam is quick enough that you can usually target and shoot each one before it reaches you. Add your dash maneuver while you're shooting, and any you miss will crash into the ground where you formerly stood.



The cylindrical Arboretum has a large tree running through its center. Eventually, you must climb to the top to reach a door up there. For now, navigate around the different platforms to the other door at the base of the cylinder.

Reaper Vine

[Log Book]

Morphology: Reaper Vine
 Habitat: Chozo
 Color: Red, Black
 Body temperature: peaks at 125 Centigrade.

Reaper Vines have sharp scythelike appendages that can slice and dice an opponent. These wild vines stick out of walls and flail wildly as you approach. Blast them near their tips to make them retract into their holes. Reaper Vines only stay in their holes for a short time when shot. There is no way to permanently destroy them.



Hang a sharp right once you enter the Gathering Hall to access the Save Station. As you leave the Save Station, head straight through the Blastcaps to the door on the far side. Just before you reach the Watery Hall, shoot a missile at the wall here to reveal a Missile Expansion.



In the Watery Hall, the large gate with the runic symbols is opened by scanning the four matching symbols scattered about this area.



Hop along the platforms floating in the toxic water until you see some Blastcaps. Blow them away, and the first symbol is revealed. Scan it and continue along the floating platforms until you can go no farther. The second one is on the wall here.

CAUTION

Some Reaper Vines here will knock you into the toxic water if you don't shoot them into the wall first. Once they're safely put away, be quick about passing through their platform.



Make your way back to the door where you came in. Jump up to the raised platforms and turn around to look at the entrance to the room. Just to the right of the door is the third symbol.



Just one more symbol, and the gate is unlocked. Work your way around the raised platforms until you reach the gate. The fourth symbol (it's huge) is to the right of the gate. Scan it, then scan the newly revealed symbol on the gate itself.

TIP

Don't forget to scan the rippling wall above the Charge Beam. Collect the Chozo Lore to fill your Log Book.



With the gate opened, the Charge Beam is now yours. Hold down **Ⓐ** to charge up the beam, then release it to fire. You get your first chance to use your new weapon just to escape this area. So many Eyons appear that you can't put them all out with just the Power Beam. Unlike the Power Beam, a fully charged Charge Beam shot will destroy the Eyon for good.

THE MORPH BALL BOMB

CAUTION

Remember to save when you're in the Gathering Hall.



Back at the Gathering Hall, use the ledges and platforms lining the walls to reach the broken bridge above the room. Go through the door across the bridge and make your way to the Energy Core.



Right now, there's only one way that you can go through the Energy Core. Hug the wall to your left until you see a hole that only the Morph Ball can fit into. Roll through the piping until you reach the Burn Dome.

Stone Toad



Stone Toads like to sit in one spot and one spot only. You will never see these guys move. They are harmless unless you are in the Morph Ball form. If you get near a Stone Toad in Morph Ball mode, it sucks you up and tries to digest you. The only way out is to lay a bomb while you're inside or wait until it spits you out. Because you haven't picked up the Morph Ball Bomb yet, keep your distance from it when in Morph Ball form.

BOSS BATTLE: INCINERATOR DRONE



The Incinerator Drone pops out of the center of the Burn Dome just as the door behind you locks shut. You are trapped, and the only way out is to defeat this flame-spitting boss.



At first, the Incinerator Drone simply spits out flame from its two "arms" as it rotates. Avoid the flames by staying between the two jets of flame. Hold down **□** to keep the Drone targeted as you circle the perimeter of the room.



The Incinerator Drone's weak spot is the red orb that pops out of its shaft. You must position yourself so that you are directly facing the red orb. Shoot it with missiles or your Power Beam until the Drone starts to malfunction. When it does, it draws the orb back into its shaft, making it invulnerable to attacks.



When the Incinerator Drone malfunctions, it shoots flame up to the War Wasp Hive above it. The Barbed War Wasps inside don't like this and begin to come out. Keep an eye on the Incinerator Drone as you snipe the Barbed War Wasps coming out of the hive. Eventually, the malfunctioning Drone starts up again.

Barbed War Wasp

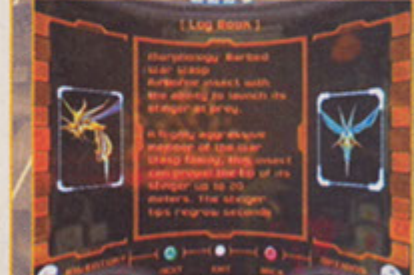

Barbed War Wasps only appear in the boss battle with the Incinerator Drone. Their hive sits directly above the Incinerator Drone. The Barbed War Wasps get upset when the searing heat from the malfunctioning Drone reaches their home. Barbed War Wasps can shoot their barbed stingers a great distance and regrow them in seconds. It's best to destroy them as they are coming out of their hive. The Power Beam is the most effective weapon here because of its speed.

NOTE

If you don't shoot the red orb in time, it will retract. If you let it retract, you'll have to wait until it pops up again, all the time defending against flames and Barbed War Wasps.



Stand in one spot against the wall as the Drone starts up its flames again. This time, the flames will be lopsided. If you stand far enough away from the Drone, you can ignore the high flame stream; it passes over your head. You can jump the low flame stream. Concentrate on shooting at the Barbed War Wasps while jumping the low flame.



When the red orb pops up again, position yourself to fire at it. The faster you damage the orb so that it malfunctions, the less you're likely to be hit by the flame.



You must perform this process a total of four times before the Incinerator Drone is finally destroyed.



You've got it! The Morph Ball Bomb is used when in Morph Ball form. Tap **A** after you roll into the Morph Ball, and you lay a small bomb. There are a lot of uses for the Morph Ball Bomb later on. For now, just know that you can break Sandstone or Talloric Alloy objects.

TIP

Before you leave the Burn Dome, lay a bomb next to the wall blocking this hole. Behind is a handy Missile Expansion.



THE VARIA SUIT

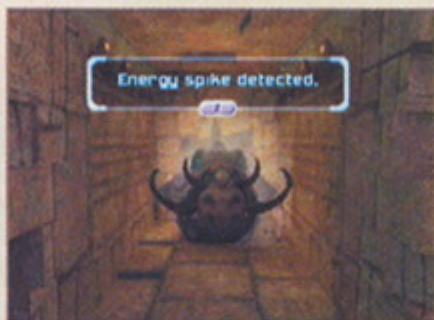

On your way out of the Burn Dome, make a stop by the Stone Toad you passed up earlier. Now that you have the Morph Ball Bomb, morph into the Morph Ball and let it eat you. Once in its belly, tap **A** to drop a bomb and reveal another room.



In this room, lay a bomb just underneath this Morph Ball slot. The explosion from the bomb will put you right into the slot. Lay another bomb while in the slot to activate the switch.



The Morph Ball slot drains the water in the center area, but only for a limited time. Stay in the Morph Ball form and roll out of the small opening in this room. You land in the freshly drained room, in plain sight of the next Morph Ball slot. Quickly activate this one the same way.

TIP

The drained room stays drained only until the timer runs out or you activate the second slot. The platforms raised by the second slot only stay raised for a limited time or until you activate the third slot.



The second Morph Ball slot raises a series of platforms that lead to the little window. You can see the window from the second slot. Once raised, you must jump from platform to platform to reach the window. Beyond it is a third Morph Ball slot that raises the last set of platforms.



Go through the door and continue on. There are a few different ways to go, but only one that you can access right now. Through the piping, you land in an opening with an Energy Tank. Energy Tanks permanently increase your Energy capacity by 100.



Return to the Arboretum, making sure to save along the way. The gate at the top of the area must be activated by scanning four runic symbols. The first one is hidden underneath the Venom Weed near the toxic water. Shoot the Venom Weeds to make them retract and reveal the symbol. Scan it and start making your way up the different platforms and ledges.

Venom Weed



Venom Weed is a toxic form of the Tangle Weed. The Venom Weed slows you down as it poisons you. Shoot it to make it retract into the ground before passing through a patch.



The next symbol is on the tree, near the wooden bridge.

CAUTION

Be wary of the War Wasps in this area. They can easily knock you off your perch and into the toxic waters below. Use your missiles to destroy the hives so that they don't keep coming.



The third symbol sits next to one of the stairs on the ledge.



The last symbol is on the tree right next to the gate. Get up to the gate and look at the tree.



Lay a bomb at this structurally weak section of the wall. When it blows, it reveals an opening just big enough for a Morph Ball to fit through.



If you're low on Energy, bust through the crates in the following passageways for a fill-up. You'll need all the Energy you can hold for the next fight.

A few things have opened up for you now that you have the Missile Launcher, Morph Ball, and Morph Ball Bomb. You don't need to go back and get the following items right now, but they certainly make the fight with Flaahgra much easier. Later on, you'll need all the pick-ups that you can get, so you might as well grab these items now.

Missile Expansions
Ruined Shrine



Remember the Ruined Shrine? That's where you fought the Plated Beetle to receive the Morph Ball. In that arena is a small covered hole. Lay a bomb and roll on through to pick up a Missile Expansion.

Ruined Nursery

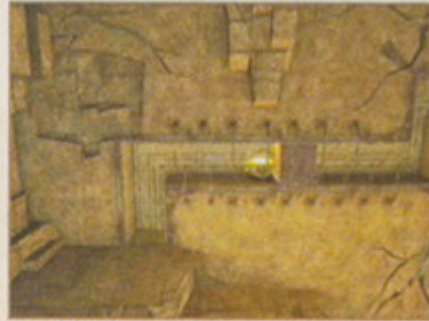

Inside the wall in the Ruined Nursery is a mazelike indentation blocked by some structurally weak stone blocks. Enter the indentation first at the lowest point and destroy the bottom block with a bomb. Once the indestructible block above it drops down, drop out of the maze and reenter it at the opening on the ledge. With the indestructible block out of the way, you can now reach the Missile Expansion at the end of the maze.

Ruined Gallery



Use the Morph Ball Bomb in the Ruined Gallery to be popped up into this raised little hole. The small piping loops around and lets out on the other side of the room. Inside is another Missile Expansion.

Vault



To access the Vault, go past the little room beyond Hive Totem and hang a right at the elevator. Getting the Missile Expansion out of the Vault requires some precise timing. You must lay a bomb in front of each of the first two locks to clear away the stone. Lay a bomb in midair to clear the second lock's stone.



The third lock is the tricky one. It is too high for you to reach with a single Bomb Jump. You must lay three successive bombs at precise times to reach it. Position yourself in front of the hole and lay the first bomb. Just before the bomb explodes and pushes you up, lay the second bomb. As you near your peak from the first bomb, lay the third bomb in midair. The idea is to time it so that as you land from the first bomb, you are immediately popped up by the second. By the time you reach your peak from that second bomb, the third bomb in midair will pop you up to the previously unreachable height. This takes a little practice, but you must learn this skill; you must perform this maneuver later on in more dangerous situations.



Dynamo



In the room where you picked up the Charge Beam is a hole that can be accessed with a Morph Ball Bomb. At the end of the tunnel is a room with two Missile Expansions, but you can reach only one. Use a missile to destroy the metal structure blocking your path to the Missile Expansion.

Energy Tank

Plaza Access



Plaza Access is the one that leads from the Vault into the Main Plaza. However, it is too high to reach from the Main Plaza, so you must enter it from the Vault. There's no puzzle to reach it; just go to the end of the tunnel and there it is.



BOSS BATTLE: FLAAHGRA



Flaahgra is a huge mutant plant that's been making all the water around here toxic. To destroy this evil poisonous plant, you must first disconnect it from its source of energy: sunlight. Once its sunlight is cut off, Flaahgra becomes inactive long enough for you to lay a bomb in each of the four tubes running from its base.



To cut off Flaahgra's sunlight supply, you must use your Charge Beam or fire a missile at the glowing red orb at the base of the reflectors. When you hit it, the reflector is knocked out of commission. After you knock the first one down, Flaahgra retracts its roots from the four tubes at the base.

The most effective way to reach the reflector is to hold down **[L]** to lock on to Flaahgra. This way, you can strafe around to the reflector while you shoot Flaahgra. Although your shots won't hurt Flaahgra, your missiles and Charge Beam will stun it for a short time.

TIP

If you use missiles to stun Flaahgra, make sure you wait for it to recover before shooting another one. Hitting Flaahgra while it's already stunned only wastes missiles.



Once Flaahgra is down, quickly morph into the Morph Ball and roll down one of the tubes. When you reach the end of it, lay a bomb to destroy that part of Flaahgra.

After the first tube is destroyed, two reflectors are knocked into place. You must now repeat what you just did, except this time there are two reflectors to shoot at. The tricky part now is to knock the second one before Flaahgra gets a chance to flip the first one back.



To accomplish this, hold down **[L]** to lock onto Flaahgra and begin to strafe to one side; strafing is much faster than running, and this keeps you focused on Flaahgra while you circle the area. Keep your Charge Beam ready to fire at Flaahgra every time it comes to. When you reach a reflector, fire the Charge Beam at the red orb to knock it back.



Once the first reflector is down, continue along the same pattern to the next one. It is crucial that you continue stunning Flaahgra. If you fail to stun it, it will knock the previous reflector back up, and you'll have to start over.

When you successfully knock down both reflectors, you must find a nearby tube and blow it up from the inside. When you blow up the tube, both reflectors are reset, in addition to a third one. Use the same technique to knock back the three. Once that is done, all four reflectors are reset, and you must do it all over again.

TIP

Keep a steady strafe around Flaahgra as you go for the reflectors. As long as you keep it stunned from your Charge Beam, it can't knock back the reflectors already hit.



The fight is finally over when the fourth and final tube is blown up. Your prize for defeating Flaahgra is the Varia Suit.

NOTE

With the Varia Suit, you can now safely explore Magmoor Caverns, a place that was too hot to go to without the proper gear. Note that although the Varia Suit will protect you from heat, it can't protect you from lava.



Magmoor Caverns First Visit

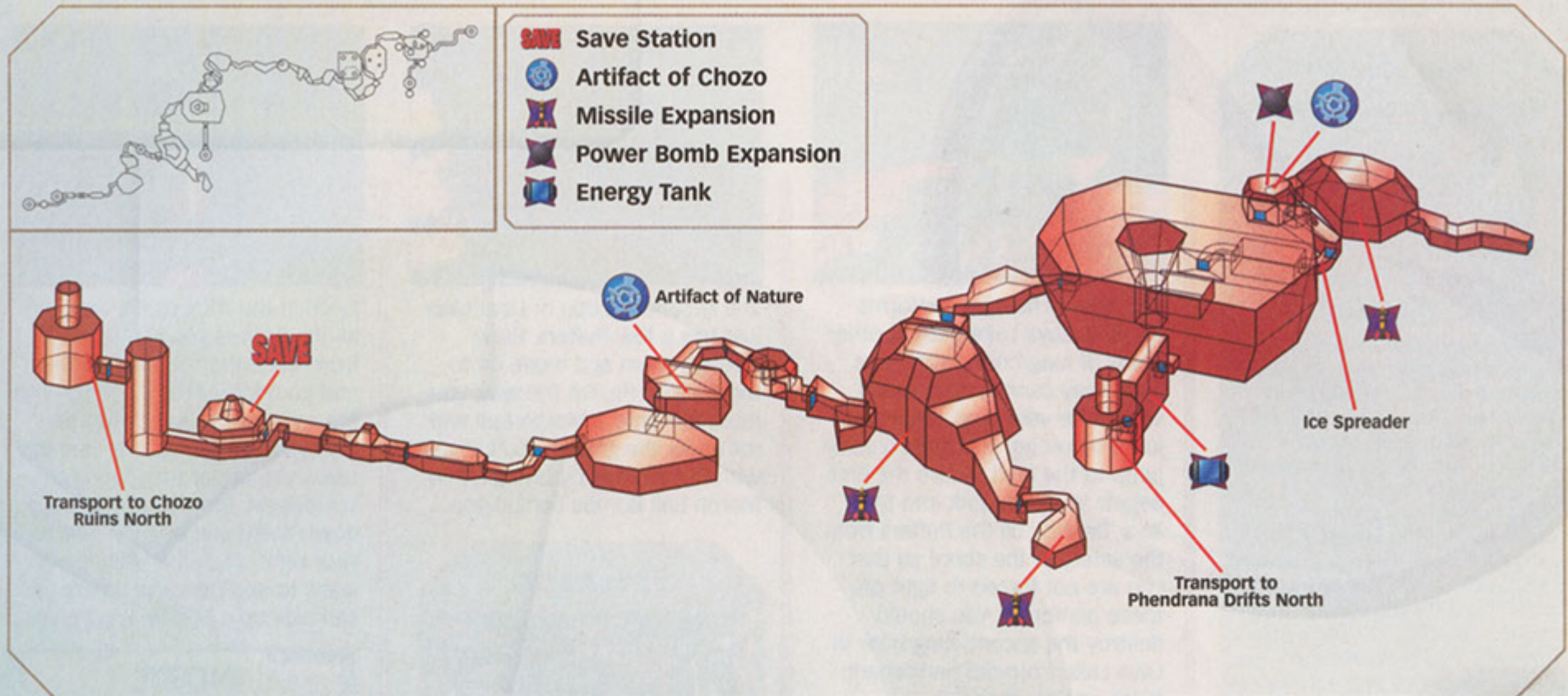

MAGMOOR SECTION 01 MAP

COLLECTING THE GOODIES



When you enter Magmoor Caverns from Chozo Ruins, you are only a few tunnels away from a Save Station. Magmoor Caverns is teeming with deadly molten lava; forgetting to save could mean repeating a lot of hard work.



Moving forward out of the Save Station to Lava Lake, you encounter your first enemies in Magmoor. You've seen the Shriekbats shrieking toward you before, but the Grizby on the floating platform is a new foe. Missiles are the only effective weapon against Grizbies. The flames coming out of the two pipes are lethal and can push you into the lava. Wait for each one to stop before skipping on to their respective platforms.

Burrower



Burrowers like to hide in the ground and pop up high into the air when they sense nearby seismic activity. The best way to deal with these guys is to shoot them from afar. A quicker way to deal with them is to roll into the Morph Ball, roll through their territory, and lay a few bombs where you see them digging their path.



When you reach Lava Lake, you find out what a Magmoor is. The fire-breathing serpent lives in lava and attacks you as you near its habitat. Keep your distance and destroy it with a few shots from your Charge Beam.

Grizby



Grizbies are small armored creatures that roam the rocks around Magmoor Caverns. They aren't aggressive creatures and like to patrol in set patterns. They are indestructible to everything but missiles.



Magmoor



Magmoors are dragonlike creatures that live in the molten lava of Magmoor Caverns. They emerge out of the lava and shoot flames out of their mouths as you near them. Magmoors are most susceptible to cold attacks, but heavy-damage weapons such as Missiles and the Charge Beam are also effective. Their flame breath has a limited range, so if you stay out of reach, you can send the Magmoors back to their fiery depths with ease.

Puffer



Puffers are filled with the lethal meta-viprium gas and float about hunting for food. Aggressive hunters, they can knock you off small platforms. You can easily destroy them with a few shots from your Power Beam. The gas they leave behind can harm you for a short time after they are destroyed.



The type of floating platforms found in Lava Lake exist in other areas of Magmoor Caverns as well. They cannot carry much weight for very long. Once you jump onto one, you must quickly jump to the next before the first begins to slowly sink into the lava. Destroy all the Puffers from the safety of the shore so that you are not forced to fight on these platforms. You should destroy the second Magmoor in Lava Lake from the permanent ledge against the wall.

TIP

Remember to use the Charge Beam to suck up any Energy or missiles left hanging above the lava. Simply point the Charge Beam toward an out-of-reach Energy or missile power-up to suck it in.



Lava Lake is divided into two separated sections. On the opposite shore of the first section are some crates that hide a weak sandstone wall. To get through, lay a Morph Ball Bomb and roll on through. There are a total of two such walls to blow up before you emerge in the second section.



The second section of Lava Lake just has a few Puffers. Plow through them and move on to the Triclops Pit. On the way, you must turn into a Morph Ball and roll under the grating. You can deal with the Triclops by laying a few Morph Ball Bombs behind you.

Triclops



Triclops are tiny creatures with powerful jaws. When you are in Morph Ball mode and wander in front of them, they pick you up and deposit you in inconvenient places. Lay a few bombs in your wake, and they will pick the bombs up instead of you. When the bombs explode, so do the Triclops. If you become caught in their jaws, you'll take some damage. Roll the around to dislodge yourself from its mandibles. As soon as you're free, lay a few bombs so that they pick them up and explode.



Once in the Triclops Pit, destroy all the Puffers you can target from the entrance. Drop down and go underneath the ledge into the cave below. As the Morph Ball, you can access the pipe that takes you under the grating of Triclops Pit. Blow up the Triclops down there and hug the wall to your right. The pipe leading out leads to another cave where you can pick up a Missile Expansion.

NOTE

Your visor gets steamed up from the vents in this area. It doesn't hurt, but the condensation does obscure your view for a moment.



Get out from underneath the grating and back to near the entrance. Be sure to destroy all the Puffers above the floating platforms, then skip your way across to the far side.

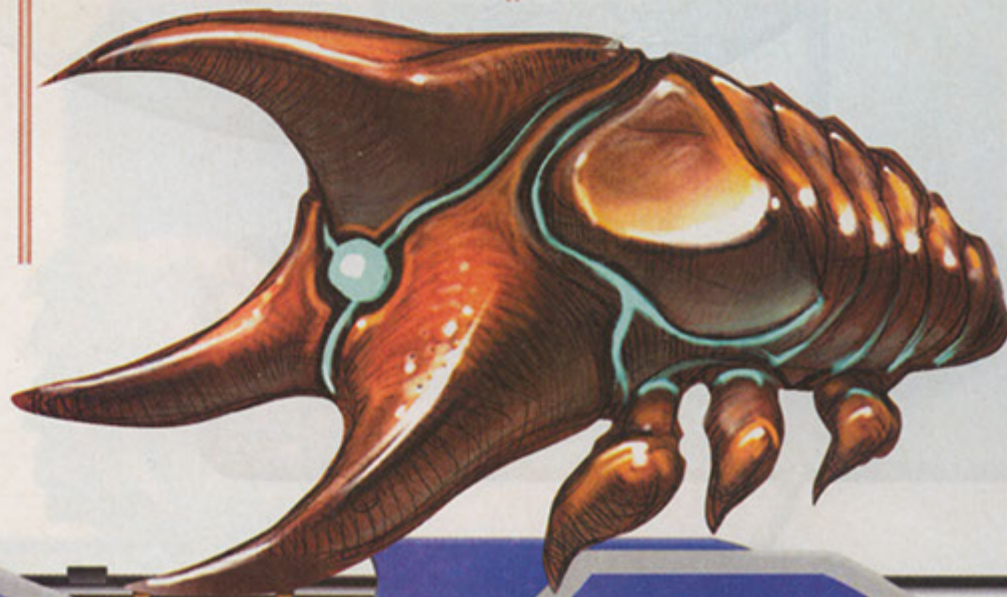



Don't go storming blindly into Monitor Station. There are four Auto Defense Turrets in here that can rip you to shreds. As you enter, you can target and destroy three of them with your missiles. Look for the green lights of the turrets in the structure in the center of the area. There is one centered in front of you and two on the left side. A couple missiles will destroy each.



With three out of the four turrets destroyed, it's safe to make your way to the door on the left side of the area. Through the door, you pass through a few tunnels and some flame-spitting pipes from the ceiling.



At the next open area, destroy the crates so that you can jump over to the small ledge. From the ledge, take care of the Magmoor that pops up, then jump over to the Triclops. You can access the open pipe there by performing a Bomb Jump.



When you come out of the pipe on the other side, shoot the crates and roll along the ledge to reach the series of platforms. Use Bomb Jumps to get up to the suspended path above. Follow the path very carefully; fall off, and it's a painful swim back to shore.



A Missile Expansion awaits at the end of the suspended path. After claiming it, drop to a small ledge with guarding Triclops. From here, you can jump over to the open pipe you entered earlier. Retrace your steps to Monitor Station.



When you enter Monitor Station, you find that the Auto Defense Turrets you destroyed earlier have been repaired. Two of them are now pointed at the door you enter from. Duck in and out of the open door and launch missiles at the turrets to destroy them. Once those two are destroyed, you can safely enter the area and destroy the third one on the right.



The fourth Auto Defense Turret is on the left side of the center structure. You can safely destroy it once you jump over to the center structure and look up at it from below.



Use the floating platforms to access the ledges surrounding the center structure. From this ledge, you can jump onto the broken catwalk of the center structure. Follow the catwalk and cross the bridge that leads to a door.



Through the Morph Ball hole, you reach a vertical maze of tunnels and blocks. There is an Energy Tank hidden at the top of this maze. You can't reach it or even see it until you perform a Double Bomb Jump.



Position yourself over this box. Lay a bomb and wait until just before it explodes before laying the second. When the first bomb explodes and pops you into the air, immediately lay a third bomb in midair. By the time you drop down to the ground again, the second bomb should pop you right back up, just in time for the third bomb to knock you up even higher. At the peak of your jump, move the  to the left to grab the Energy Tank.



The box where you position yourself for the Double Bomb Jump is destroyed after two detonations. The lava below makes it a dangerous maneuver. Fortunately, the box regenerates after a short time, and you can try again. Perfect the Double Bomb Jump at this spot so that you minimize your chances of being burnt.



Continue past the vertical maze and into the Transport to Phendrana Drifts. Activate the elevator by scanning the switch, and walk through the hologram to set it in motion.



Phendrana Drifts First Visit

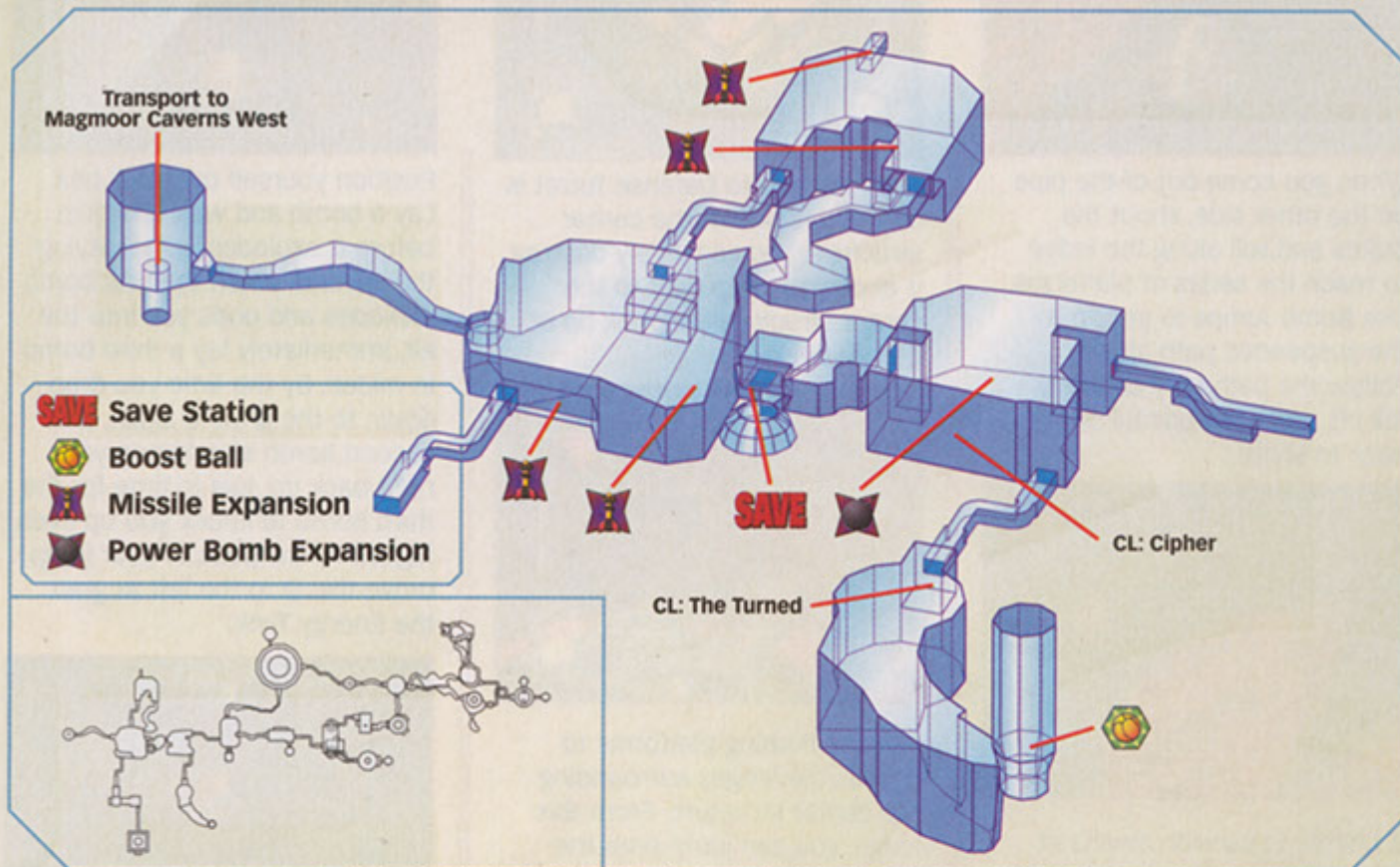

PHENDRANA SECTION 01 MAP

THE BOOST BALL



Leaving Magmoor Caverns, you enter Phendrana Drifts for the very first time. This icy land is home to some of Tallon IV's nastiest indigenous creatures, such as the Sheegoth. Don't break out your winter jacket just yet, though. You won't be staying long.



Head through the icy cave and destroy the ice walls with your missile. The cave leads to Phendrana Shorelines, a large area with a river of icy water cutting through the middle.



Flickerbat



Flickerbats fly at such amazing speeds that they're difficult to see without the aid of an X-ray Visor. As they zoom around in circles high above the ground, they sometimes slow momentarily, which gives you a split second to lock on and fire. In most cases they won't pose a threat to you, but when trying to pass them during a series of jumps, you must pick them off before making your crossing. Try to manually target them and use a weapon with a high rate of fire, such as the Power Beam.

Crystallite

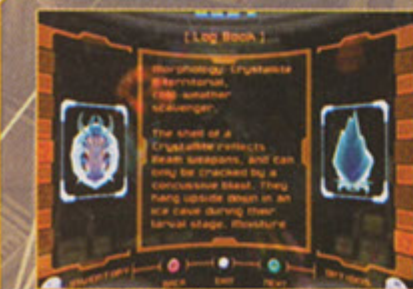

Crystallites are tiny little creatures that would seem almost harmless if not for their rigid ice carapace. They crawl around on frozen surfaces and give little thought to their surroundings. Although they aren't hostile creatures, they can cause damage to Samus should she accidentally step on one while crossing their territory. Crystallites are invulnerable to all weapons except for missiles and the Plasma Beam.



Directly across from your position is a Save Station. Make good use of it before venturing farther.



Look to the right as you leave the Save Station to see a large metal gate in a small channel. Blast the grate with a missile and roll over the snowdrift behind it. Scan the panel on the wall to unlock the door overhead.



Look for a series of small ledges above the Save Station. Use these to reach the door you just unlocked. The tunnel behind it leads to Ice Ruins East.



Scatter Bombu

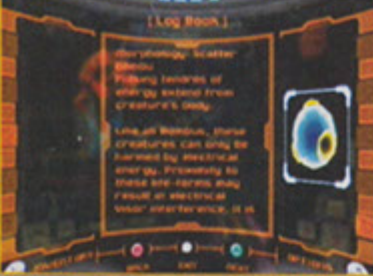

In narrow halls you'll often encounter this menacing electrical creature. These unusual beings emit three static beams that connect with nearby walls as it spins in circles and travels back and forth down the hall. This creates an obstacle early in the game, which you can bypass in Morph Ball mode. The Wave Beam is the only weapon able to destroy a Scatter Bombu, so until you locate that, you'll have to skirt through its spinning trap.



As you leave the tunnel, you come face-to-face with a fearsome sight. Two Baby Sheegoths are waiting in the snow and they won't be pleased to see you. You can easily avoid this battle by running past the babies and jumping onto the ledge to the right.



Hop up to the top and follow the ledge steadily to the left, and it will lead you to the Plaza Walkway, which returns to the Phendrana Shorelines.



Stay on the high ledge over the Phendrana Shorelines and continue through the next door to Ice Ruins West. Again you're faced with two Baby Sheegoths, but you can quickly cut past them to the door in the far right corner if you act fast.



Baby Sheegoth



The only thing more fierce-looking than a Sheegoth is one of its toothy offspring. Though considerably smaller than their parents, these bull-sized beasts are far from harmless. They love to charge at their prey and often attempt to freeze potential meals in their icy breath. The best strategy is to lock on to your enemy and strafe around behind it. Their only weak spot is the ice dome on their backs. Use a charged Power Beam shot to destroy the ice, then you can pick off the creature with just a couple more pecks. Once you have the Plasma Beam, these creatures will be little more than a nuisance, but for now they present a worthy challenge.

Ice Burrower



Much like their warm-blooded cousins found in Magmoor Caverns, these creatures can be found scurrying through the snow while waiting for would-be victims. Either scatter Morph Ball Bombs around their tracks, or wait for them to pop out of the snow and blast them with your Power Beam, or your Plasma Beam later on in the game. They're easy to avoid, which is often the best option.



Through the next tunnel, you enter Phendrana Canyon. At the far end sits a tower containing the Boost Ball upgrade. Drop to the canyon floor, then climb the icy slope on the right to find a switch on a ledge. Scanning the switch aligns a long line of platforms to the tower.



Hop across the platforms and move quickly. If you hesitate, the platforms will collapse under you and you'll fall. In such a case, you must return to the switch, reset the platforms, and try again. When you reach the tower, you can grab the upgrade without so much as a fight.



The Boost Ball upgrade allows a quick Speed Boost when in Morph Ball mode. The valley below is U-shaped and is commonly known as a half pipe. Using the Morph Ball and Boost Ball, you can rocket up the right side of the valley to the ledge above. Use the Speed Boost by holding **Ⓢ** for a moment and then letting go. Immediately begin charging another Boost, and as you near the opposite side, Speed Boost again. You'll go higher than before. Repeat these steps until you can reach the ledge.

TIP

When using the Boost Ball upgrade in a half pipe, you'll find that proper timing is very important. In order to gradually increase the height of each roll, you must Boost just as you begin to go up each side. As soon as you use a Boost you should always begin to charge another, or you won't gain as much height as possible.



Leave the canyon and backtrack to Phendrana Shorelines, and then to the transport leading back to Magmoor Caverns West.



Tallon Overworld Second Visit

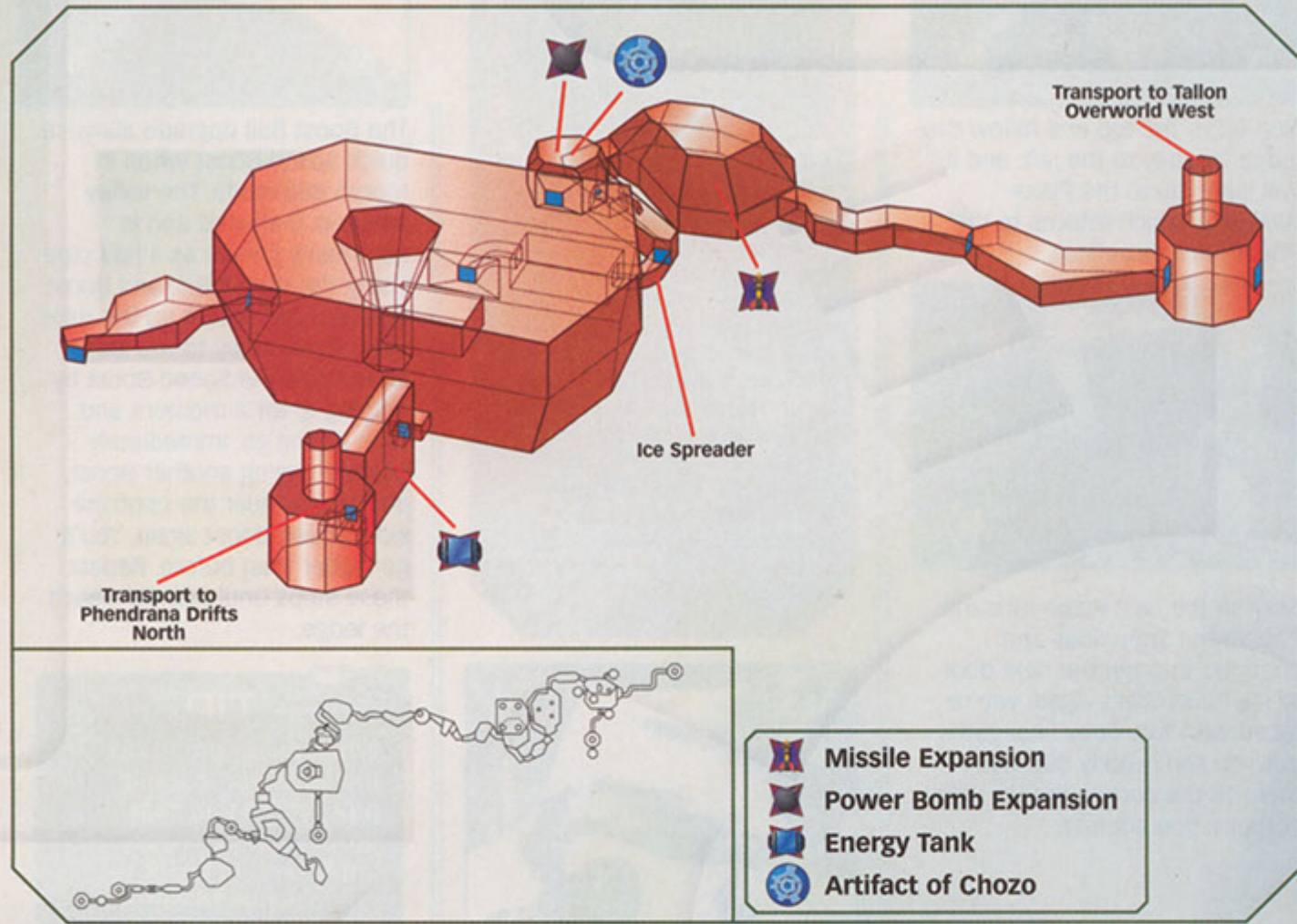

- Missile Expansion
- Power Bomb Expansion
- Energy Tank
- Artifact of Chozo

MAGMOOR SECTION 02 MAP

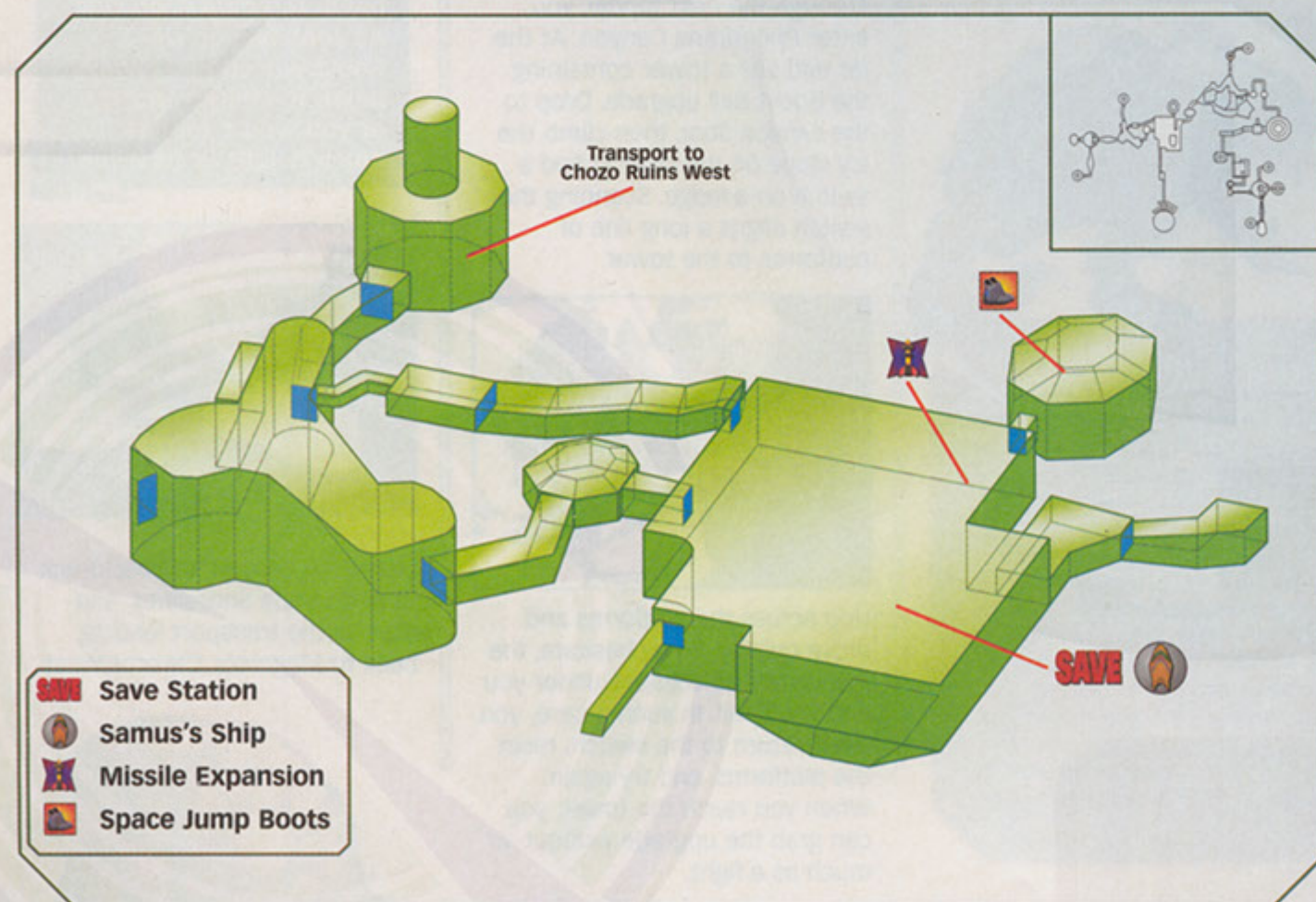

- Save Station
- Samus's Ship
- Missile Expansion
- Space Jump Boots

TALLON SECTION 02 MAP

THE SPACE JUMP BOOTS



As you reenter Magmoor Caverns, you come back to the Monitor Station. This time you're going to take a slightly different path to get to Tallon Overworld, where a half pipe structure has been detected.



Fight your way through the Monitor Station and into the tunnel directly across the room, which leads to Fiery Shores. Being careful of the flame geysers, jump across the lava to a pipe in the wall below a Triclops. Bomb Jump into the pipe, and it will safely lead to the Transport to Tallon Overworld West.



You exit Magmoor to find yourself near the Root Cave. As you pass through Transport Tunnel B, be sure to check under the stone bridge. It may look dangerous, but it isn't. Sitting below the bridge is a Missile Expansion.



Continue into the Root Cave. A horde of Beetles attacks you. Ignore them and hop up the roots on the opposite side of the Beetle pack. Now you must make several treacherous jumps over small ledges to reach the door leading to Tallon Canyon.



Drop to the floor of Tallon Canyon to find the half pipe that you passed through before on your way to Chozo Ruins. After clearing out the Beetles, use the Boost Ball to rocket up to the ledge above the half pipe.



Once you have the Space Jump Boots, return to the Landing Site and make a quick stop at Samus's ship to save, restore energy, and reload. Before we head back to Phendrana Drifts, we should take a moment to explore more of Tallon Overworld.



The hall leads you to the Chozo's Artifact Temple. This large statuary holds a powerful creature at bay. In the center is the first Chozo Artifact, the Artifact of Truth. Each statue is counterpart to a Chozo Artifact. There are 12 in all. Once you've found them all, you'll be able to break the statuary's seal and battle the evil held within. Scan the statues to get hints about the locations of each Artifact.

Bloodflower

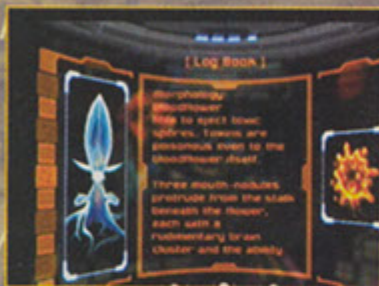

These giant plants emit a deadly toxin, which is harmful to anyone who draws too close. The Bloodflower also shoots balls of poison at nearby enemies. The poison balls travel slowly and can be shot out of the air. Doing so not only saves you from taking damage, but it causes a small lick of flame to fly back into the Bloodflower, which burns it to a crisp. This is the best way to eliminate these evil flowers, but later in the game, the Plasma Beam is equally effective.

TIP

Be sure to eliminate the Zoomers sitting on the ledges before you jump. They don't require much effort to eliminate, and it will save you from taking some damage or even falling off.



Follow the ledge around and find a series of Sandstone walls. Destroy them with Morph Ball Bombs and follow the tube back to the Landing Site.



Hop across the ledges, but avoid falling to the ground below. This takes you to the alcove overlooking the Landing Site. The alcove contains the Space Jump Boots. With this latest upgrade, you can perform double jumps, which allow you to reach higher places and make longer jumps easily.

TIP

To use the Space Jump Boots, jump normally by pressing **○**. Once you're in the air, tap **○** a second time to perform a second jump.

THE ARTIFACT OF TRUTH



Near the ship is a waterfall. A small ledge runs past the waterfall to a door above and into the Temple Hallway. Find your way up and enter the hall, but be ready for some nasty resistance. Three Seedlings cling to the ceiling, and they can rip you to shreds if you don't act quickly. Lock onto each one and pepper it with your Power Beam.

Seedling



These plantlike creatures look like blue shrubs that slither and slide along nearly any surface. Though they don't appear to be much of a threat, they can shoot their dorsal spines, which home in on nearby enemies. Practically any weapon is effective against them. Just be sure to shoot quickly when you see one, because their attacks are very difficult to avoid.

TIP

You'll notice that not all of the statues provide hints at this time. Don't worry; as you find the first five Chozo Artifacts, other hints become available.



Now you're ready to get back to work. Head back to Magmoor Caverns by way of the Transport near Root Cave.



Phendrana Drifts Second Visit

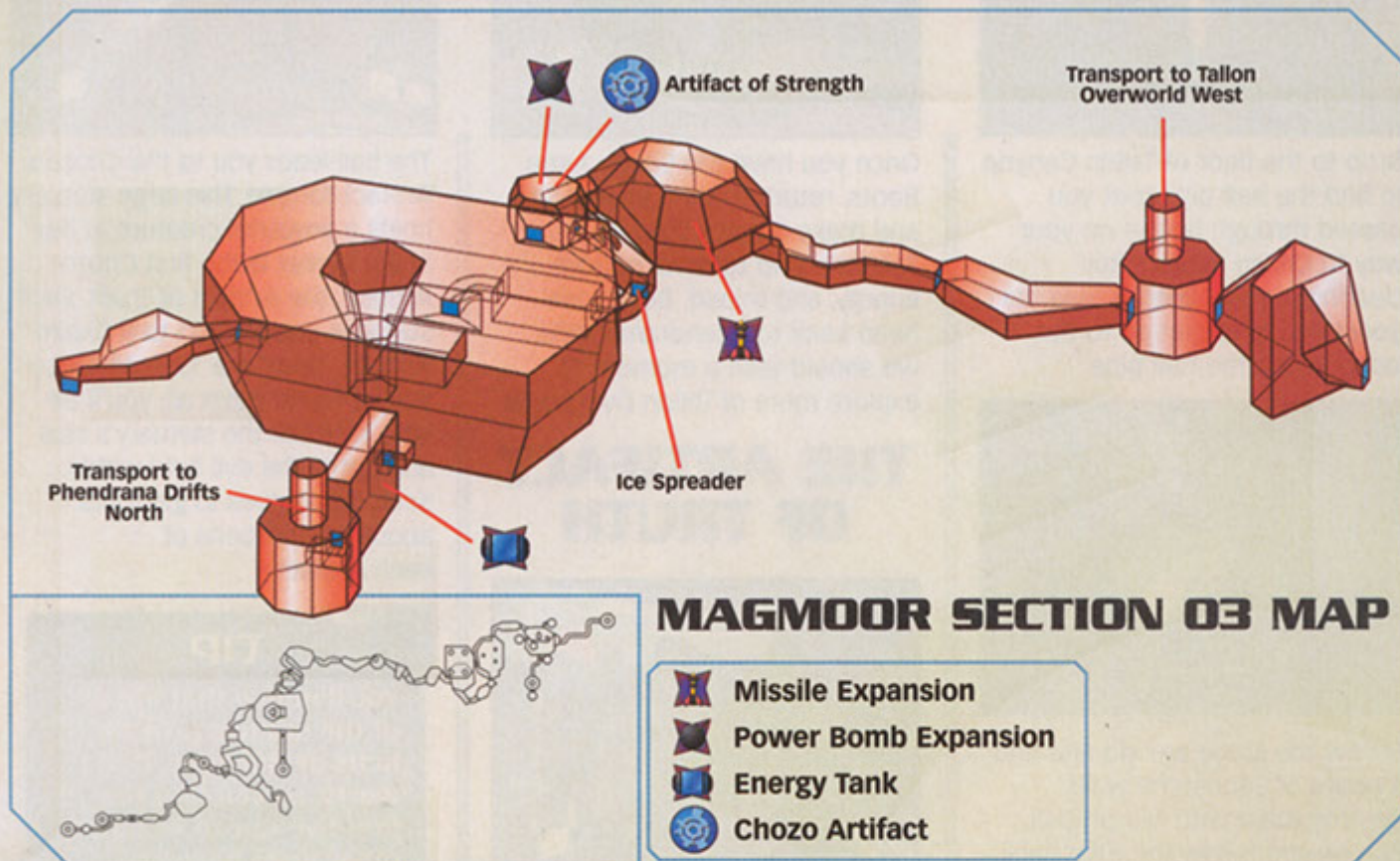

Follow the ledge around, which leads you to the Warrior Shrine. There waits the Artifact of Strength, your second Chozo Artifact. Return downstairs and move on to Phendrana Drifts; use the Transport to Phendrana Drifts North (off the second floor of the structure in Monitor Station).

THE WAVE BEAM



Upon entering Phendrana Shorelines, be sure to make a quick stop at Save Station B, and then you're ready to tackle the Chozo Ice Temple.

THE ARTIFACT OF STRENGTH



On your way back to Phendrana Drifts, you make one quick stop in Magmoor Caverns to collect the second Chozo Artifact. Head to Monitor Station and climb to the top floor of the central structure. You must use the Space Jump Boots to leap up from the second floor to the third via a small platform near the exit to Transport Tunnel A.



On the top floor of the structure is a Spinner plugged into a large console. Enter the Spinner and use the Boost Ball technique to raise the bridge to the side.



Double jump from the end of the bridge over to the ledge against the far wall.

PHENDRANA SECTION 02 MAP

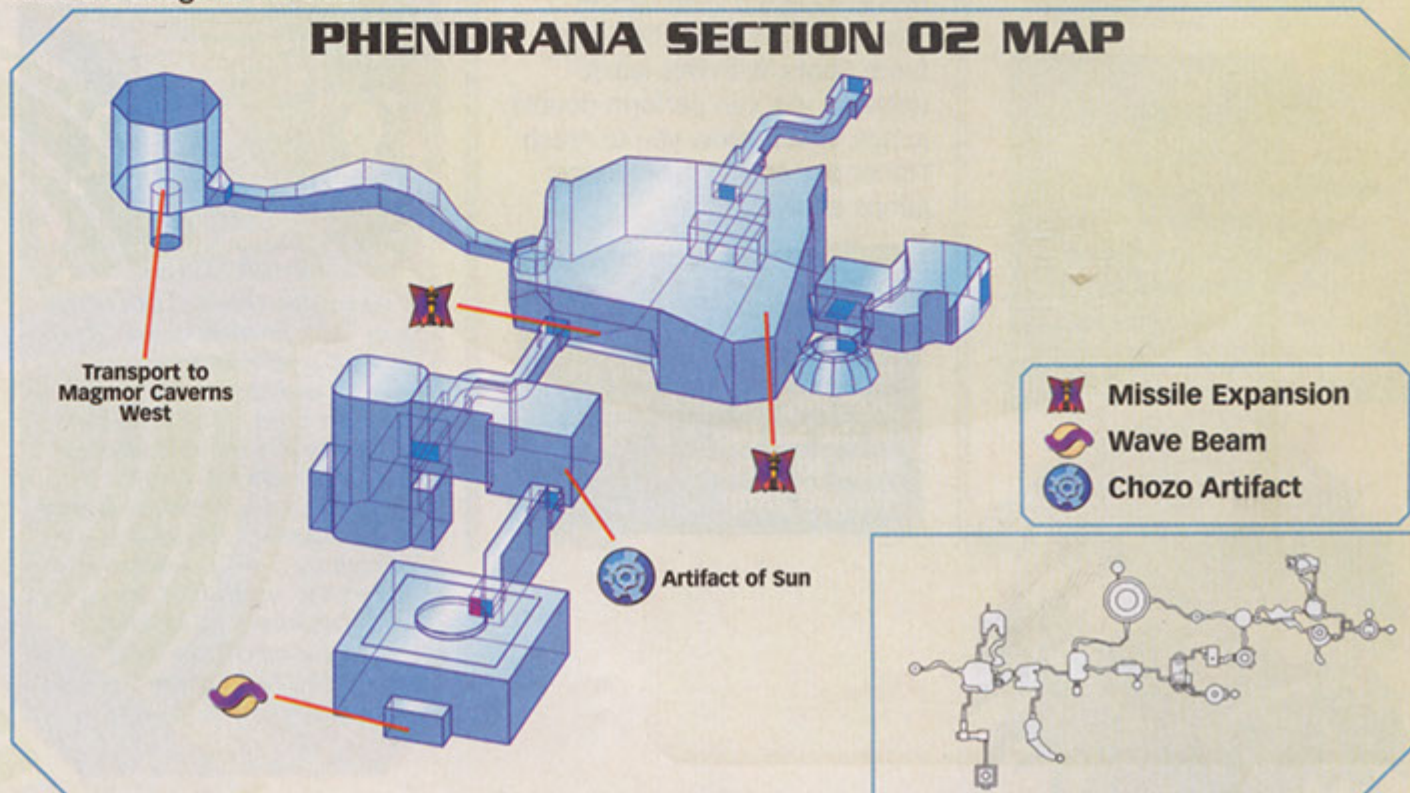



Hovering over Phendrana Shorelines are several icy platforms. You can reach them only by double jumping from the ledges above Save Station B. Hop onto the nearest floating platform, double jump to the next, and finally to the huge Chozo Ice Temple.



The first hall is filled with Scatter Bombus and Pulse Bombus. You still don't have the weaponry to defeat these electric menaces, so use your Morph Ball to quickly fly past them for now.



Once you're past the Bombus, you enter the Chozo Ice Temple. Unfortunately, a Baby Sheegoth has taken up residence in the hall, so you'll have to deal with it first. This is a tight area, so strafing is difficult. Move close to the Baby Sheegoth and quickly slide behind it to deliver the fatal blow.



The hall goes up at the end, and stone ledges are on both sides. Jump from ledge to ledge to reach the top. When necessary, pick off the enemies crawling on the walls.



Ice Parasite



Ice Parasites have adapted to the frigid environment of Phendrana Drifts. Like the rest of the Parasite family, shoot them quickly with your Power Beam before they get a chance to reach you. If in Morph Ball mode, you can roll right by them without taking much damage before they settle on the floor.



A gate adorned with a statue of a Chozo Shaman blocks the path at the top of the hall.



Scan the busts in the hall to find the bust of a Chozo Shaman. Destroy the bust with a missile to reveal a Morph Ball slot. Bomb jump into the slot and set off a bomb to unlock the gate.

TIP

Take note of the frozen statue near the locked gate. This statue holds an important secret that you won't be able to access until you've found the Plasma Beam much later in the game.



Enter the Chapel Tunnel in Morph Ball mode. Stone columns block the path. Blast through the blocks in the floor and drop down. Set two Morph Ball Bombs next to each column to clear the path overhead, and you'll be able to enter the Chapel of the Elders.



Inside the chapel you find a welcome sight. The Wave Beam upgrade sits on the opposite side of a large room. Don't get too excited; as you near the Wave Beam, it is pulled into the ground and you are attacked.

BOSS BATTLE: SHEEGOTH



In each corner of the Chapel of the Elders is a square room. As the battle begins, two of these rooms are destroyed and a Baby Sheegoth emerges from each. These enemies are easy to defeat, because there's a lot of room to strafe and dodge. Whenever you defeat one of the Baby Sheegoths, another appears from one of the remaining rooms. Four in all must be eliminated.

Pulse Bombu



pass by them, shoot them with your Wave Beam or roll past between bomb drops.

Pulse Bombus are floating electrical creatures invulnerable to most known weapons. The electric field they produce can cause your visors to malfunction if you get too close. The only weapon that can destroy them is the Wave Beam. Unlike the related Scatter Bombus, Pulse Bombus drop pulse bombs. To



Once all four Baby Sheegoths are dealt with, the real fight begins. A fully grown Sheegoth busts through one of the side walls.



The Sheegoth likes to charge at its enemies, and it uses a freezing breath attack; you can dodge both by strafing to the Sheegoth's side. It also has an amazing defense against energy weapons. The crystals on its back absorb any energy shots, so your energy weapons won't help. These crystals also trap the siphoned energy, allowing the Sheegoth to shoot deadly energy balls out of its mouth.



Stay calm and lock on to the boss. Strafe to the side to dodge its attacks until it uses freezing breath. When it does, it exposes its gills, located on its neck right before the legs.



Quickly take aim at the gills and fire a missile into the creature's side. If your aim is true, you'll cause damage. Only a shot to the gills will injure the Sheegoth. Should you have trouble spotting them, look for air escaping from them after the Sheegoth's breath attack.



Just continue dodging to the enemy's side and using missiles until the beast is brought to its knees. If you run low on ammunition, in the corners of the arena are crates where you can get a quick refill.



Once the battle is through, pick up the Wave Beam upgrade. Now you'll be able to eliminate those Bombus that have been pestering you and get much farther into Phendrana Drifts.



THE SUPER MISSILE



Backtrack to Phendrana Shorelines and be sure to make a stop at Save Station B. Then head up to Ice Ruins West, which you've visited previously when getting the Boost Ball upgrade.



Head up the ledges to your right as you enter the area. Pass through the building to the top, and you find a good view of a huge stalactite. Lock on to the stalactite and fire a missile. This causes it to break and fall, giving you a platform that you can use to climb up the rocks behind it.

PHENDRANA SECTION 03 MAP

- Missile Expansion
- Power Bomb Expansion
- Energy Tank
- Map Station
- Save Station

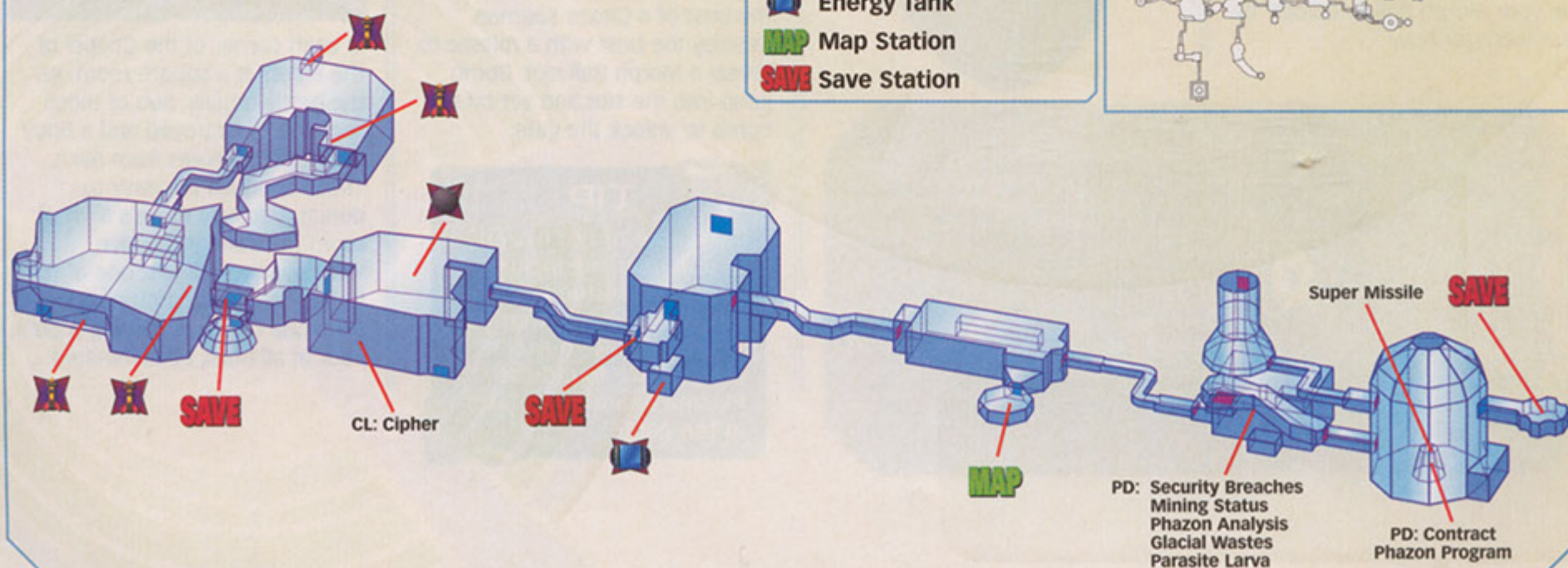



Double jump from the stalactite to the stone passage above, then follow the roofs around to the Wave Beam door, which leads to the Ruined Courtyard.



Before doing anything, look up and pick off the Flickerbats flying overhead. They'll get in your way soon if you don't. Look around the base of the canyon to find two Spinner devices. Activate them both with your Morph Ball and Boost Ball combo. This opens several large aqueducts high above.



Hop up the snow ledges to find a Morph Ball slot. Bomb Jump into the slot and use a bomb to activate it. The area fills with deep water and raises several platforms to your level, which you can use to cross the water.



Quickly cross the platforms to the opposite side, and you see a Morph Ball tunnel in the nearby wall. Pop into the tunnel, and you

fall to a room containing an Energy Tank. Drop into the hole in the floor to get back to the main room.



Activate the Morph Ball slot a second time, then cross the platforms and wrap around the center structure to find ledges leading up to the top. To your right is Save Station A. Use it before moving on.



Hop across the gap and pass through the Wave Beam door to reach the Research Entrance. As you enter the room, a Sentry Drone detects your presence and alerts several Space Pirates, who will quickly come to intercept you. Stay near the entrance and use your missiles to pick off the Space Pirates. Also be aware of a turret in the center of the room, which can play havoc on the unwary.

Shadow Pirate



Normally, these pirates have access to cloaking technology, which allows them to become nearly invisible to the naked eye. You can use a Thermal Visor to make them easy to detect and target, but during your first encounter, this enemy's cloaking device must be malfunctioning. Shadow Pirates only use close-range attacks, so try to keep your distance and keep backing up to dodge their attacks.

Space Pirate

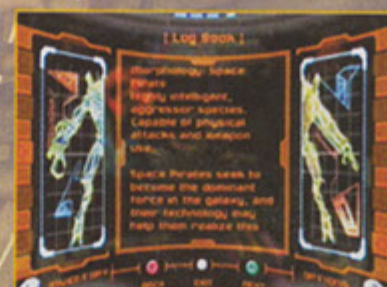

These aren't anything like the injured Space Pirates you fought back on the Space Pirate Frigate. They're healthy and ready to take you down. Don't toy with them. Use your missiles and Charge Beam to quickly rip them apart. A good strategy is to hit the enemy with a charged shot, then quickly follow with a missile for a devastating one-two punch.

Sentry Drone



Sentry Drones protect Space Pirate buildings by locking intruders in corridors and then quickly exterminating them. They're extremely vulnerable to the Wave Beam, which you should always use. Once the Sentry Drone is destroyed, the doors are unlocked and you can move on. There's no way to bypass these battles, because you're locked in with the enemy.



After the battle, you find a Map Station on the bottom floor. Download the map and head to Research Lab Hydro.

TIP

The Space Pirate labs contain lots of Pirate Data. If you're trying to fill your Log Book, be sure to check every computer screen. Those with red icons are usually Pirate Data or some sort of critical action, such as an elevator switch.



Continue through the lab to the Observatory. You must defeat five Space Pirates in the Observatory. Once they're gone, a switch appears on the console at the bottom of the room.



Scan the switch to begin activating the holographic projector in the center of the room. A Morph Ball slot appears on each side of the room, one at a time. Jump up to each slot and activate it with a Morph Ball Bomb.



Next you must use the four Spinners on the floor to lock the projector's panels into place. When the process is complete, the projector boots up and gives you a fantastic display of the solar system.

THE THERMAL VISOR

TIP

Be sure to scan the holographic display. Two of the planets, Tallon IV and Zebes, count toward your Research Data in the Log Book.



Be sure to visit Save Station D after getting the Super Missile, then move on to the West Tower to reach the Control Tower above.



As you enter the Control Tower area, several Flying Pirates assault you. These guys are nasty. Use your missiles or Super Missile to bring them down fast. Destroy the crates in the area to reload and recharge with power-ups.

Flying Pirate



These Space Pirates are equipped with jetpacks that allow them to fly. They use homing missiles to assault their enemies while skillfully dodging counterattacks. Because of their increased mobility, you must employ special tactics against them. Use missiles or Super Missiles to bring them down quickly. They almost always attack in groups, so the faster you act and the more powerful your attacks, the less damage you'll take. Also be careful when knocking them out of the sky; they try to dive bomb you as they crash.



Head down the East Tower to Research Lab Aether. There you find a Metroid trapped inside a research container. To make things easier on yourself, be sure to scan it while it's locked up. The Metroid escapes and comes after you. Quickly destroy it with your Charge Beam, then be ready for a Space Pirate who busts through the window.

Metroid



Metroids are energy-sucking parasites that may not look like much, but present a serious threat. They're resistant to all weapons except for the Ice Beam. Expect to shoot them several times to destroy them. Once you have the Ice Beam, you can freeze them and then shatter them with a missile. If a Metroid attaches to you, enter Morph Ball mode and use a Morph Ball Bomb to shake the critter off. In cases where you enter a room containing both Metroids and Space Pirates, try freeing the Metroids and watch them lay waste to your common enemies.

- Missile Expansion
- Energy Tank
- Thermal Visor
- SAVE Save Station
- Artifact of Chozo

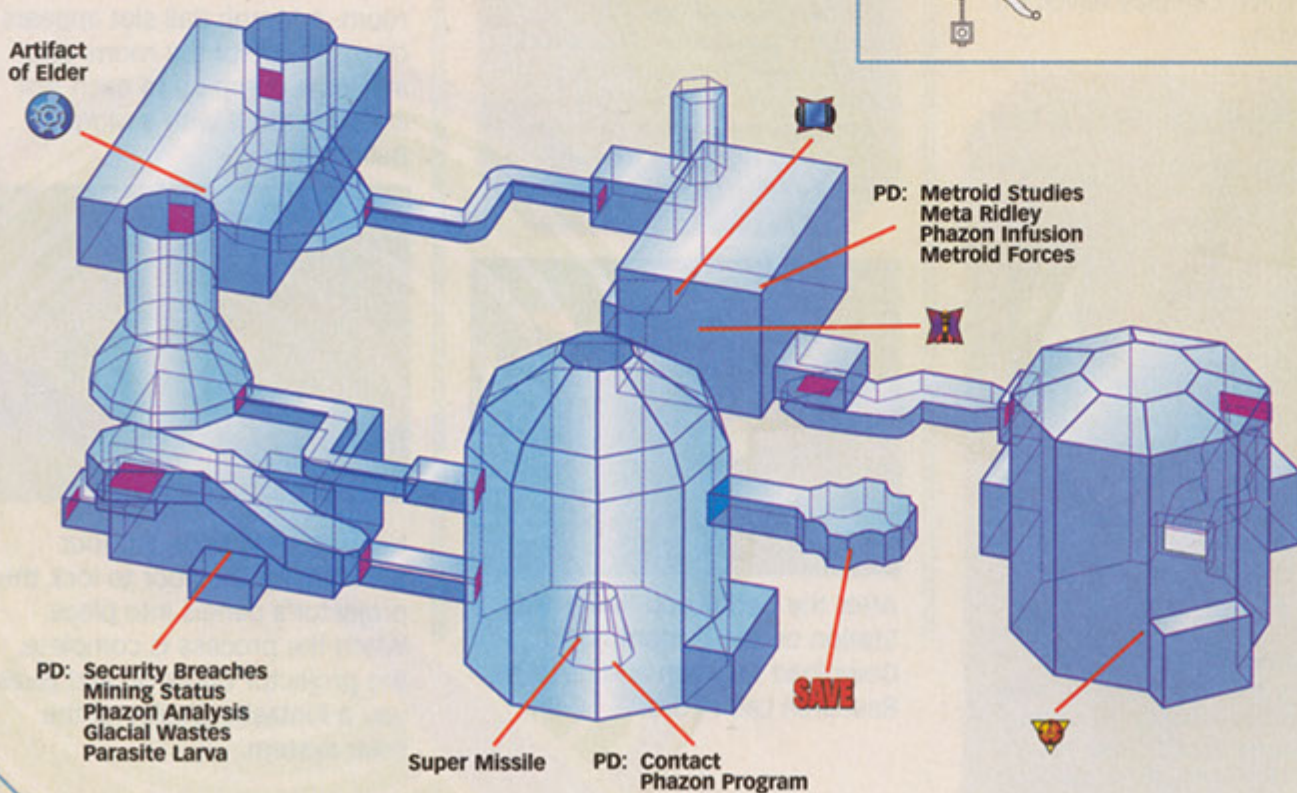
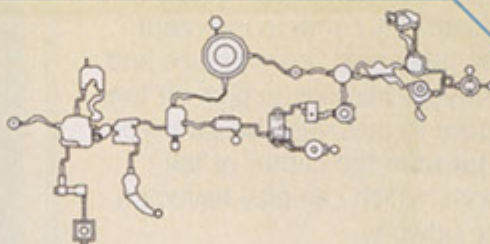

PHENDRANA SECTION 04 MAP



THE SPIDER BALL



Head through the broken window and down to the floor below. Two upgrades are in this room. Look for an Energy Tank in one of the containers. Destroy the container to reach it. There's also a small ledge above the staircase. Jump onto the ledge, then use the Morph Ball to slowly roll along it. At the end you find a Missile Expansion.



Head out of Research Lab Aether to Research Core. At the bottom of the room is the Thermal Visor, locked in an impenetrable containment field. Look for switches on each floor of the Research Core, three in all, to disable the field, then you can collect the Thermal Visor.



You get to put the Thermal Visor to good use immediately. The lights go out, and enemies attack. Switch to the Thermal Visor so you can see their heat signatures, then work your way back to the top of the room. At the top you find that the door is locked tight and there's no power to unlock it.



Use the Thermal Visor to scan the walls for a power conduit. Shoot the conduit with your Wave Beam to restore power to the door. Then begin making your way back to the Ruined Courtyard.



TIP

On your way back, be sure to look for a Cordite pillar in Research Lab Hydro. Use a Super Missile to destroy the pillar, and you find a Missile Expansion.



Once you get back to the Ruined Courtyard, visit Save Station A again; you don't want to lose all of your progress up to this point.



Hop over to the platform across from Save Station A. Above the door is a metal arch. Use a Super Missile to destroy the circular adornment, then use your Thermal Visor to look at the structure. You see a power conduit. Shoot the conduit with your Wave Beam to unlock the door.



The halls beyond the door lead to the Quarantine Cave, where you meet the toughest boss yet, Thardus.



- Missile Expansion
- Energy Tank
- Thermal Visor

- SAVE** Save Station
- Artifact of Chozo

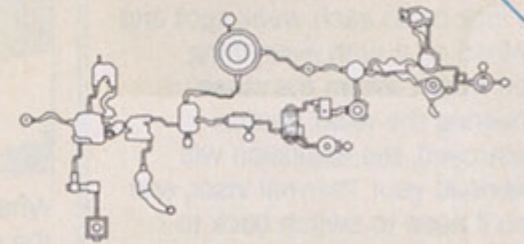

Transport to Magmoor Caverns South

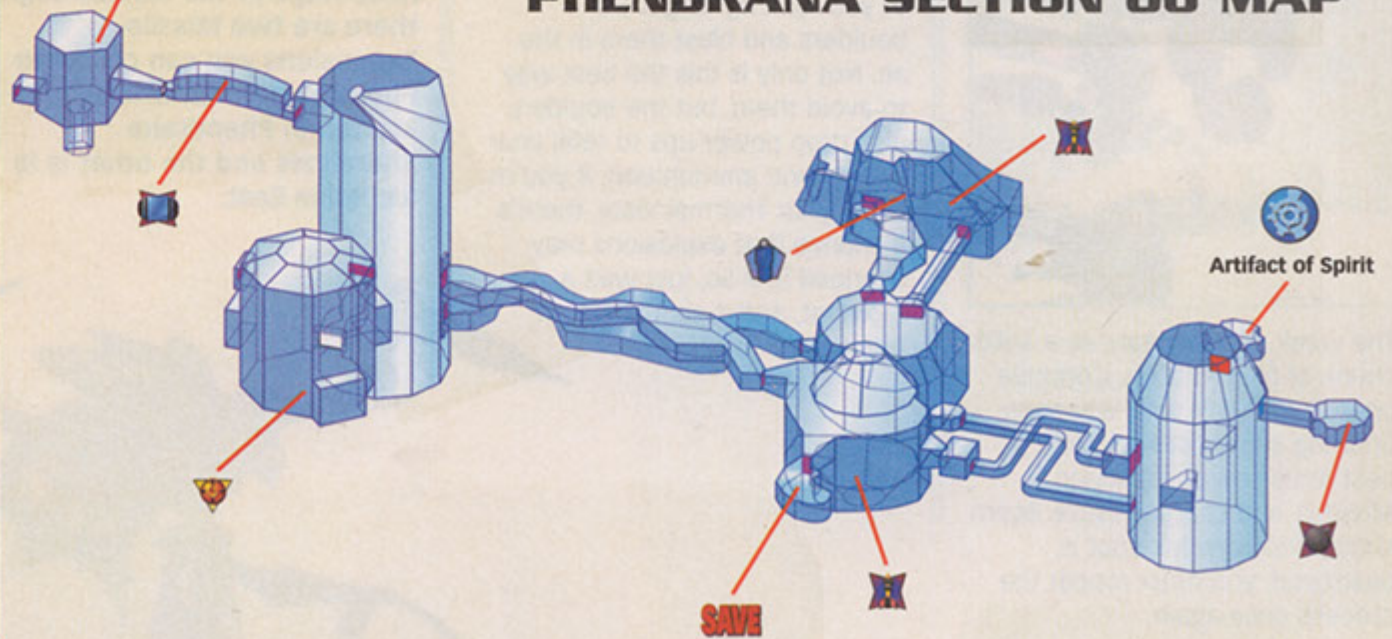

PHENDRANA SECTION 06 MAP



BOSS BATTLE: THARDUS



Thardus is tough. Defeating it requires that you slowly pick away at its stone body, which has seven points that must be destroyed. This is a long fight compared to the bosses you've faced previously.



Because of Thardus's stone skin, you won't be able to see its weak spots without the aid of your Thermal Visor. Use the visor to lock on to each weak spot and unload on it with everything you've got. When the stone covering the weak spot is destroyed, the explosion will overload your Thermal Visor, and you'll need to switch back to your Combat Visor.



The weak spot appears as a solid chunk of blue Phazon. Continue pounding it with your weapons until the spot is destroyed. It's best to use missiles, Super Missiles, and charged Wave Beam shots. Once a weak spot is destroyed, you must repeat the process once again.

TIP

After the third weak spot is destroyed, Thardus summons a snowstorm. The snow reduces visibility and forces you to draw closer to the boss. You can see through the snow by using the Thermal Visor.



Thardus has several attacks. It shoots a wave of ice by slamming its fists into the ground. The ice can freeze you, but you can break free by tapping **Ⓞ**. You can also dodge the attack by strafing to either side while locked onto the boss.



When Thardus raises its fists into the air, it summons large boulders from the ground that are hurled at you. Quickly target the boulders and blast them in the air. Not only is this the best way to avoid them, but the boulders also drop power-ups to refill your energy and ammunition. If you're using your Thermal Visor, there's a chance that explosions may overload it. If so, just wait a moment, and it should return to normal.



Thardus's last attack involves rolling into a ball and attempting to run you down. This is its most devastating weapon. As soon as Thardus begins to roll up, immediately switch to Morph Ball mode and use the Boost Ball to dodge. Keeping an eye on Thardus is next to impossible, but do your best to avoid it.



If you skillfully dodge Thardus's rolling attack and blast the boulders tossed at you, it's possible you might leave this battle with more energy than when you began. Your reward for bringing down the giant is the long-awaited Spider Ball. With it you can ride on magnetic rails by holding **Ⓡ** in Morph Ball mode.

Cleaning Up

Before you move on to the next stage of the walkthrough, there are two Missile Expansions you can collect in Phendrana Drifts. One is located in Phendrana Shorelines and the other is in Ice Ruins East.

TIP

At Phendrana Shorelines, hop across the floating platforms as if going to the Chozo Ice Temple. On the temple's wall is an ornate metal design. Destroy it with a Super Missile. This opens a passage in the tower to the left. Bomb Jump into the tower, then use the Spider Ball to reach the top, where you find the Missile Expansion.



In Ice Ruins East, look for a magnetic rail near the top of a building across from the door leading to Ice Ruins. Use the Spider Ball to cling to the rail and ride it to a small alcove containing a Missile Expansion.



When you're ready to move on, head back to Quarantine Cave and use the long magnetic rails attached to the pillars at the side to reach the Transport to Magmoor Caverns South.

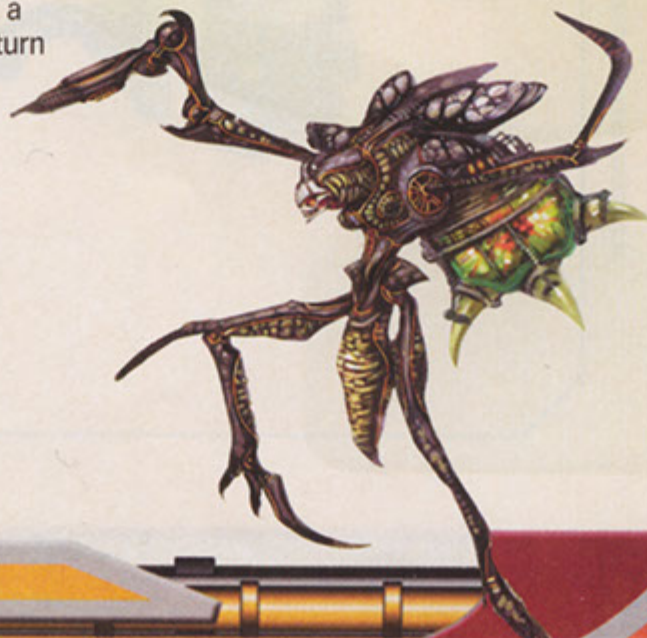

Chozo Ruins Second Visit

 Energy Tank
SAVE Save Station

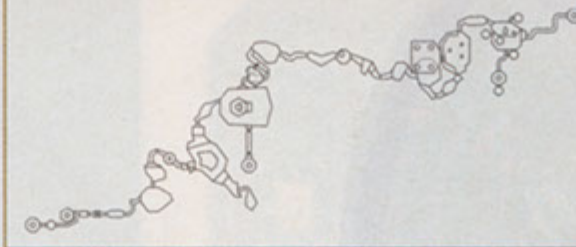

Transport to Tallon Overworld West

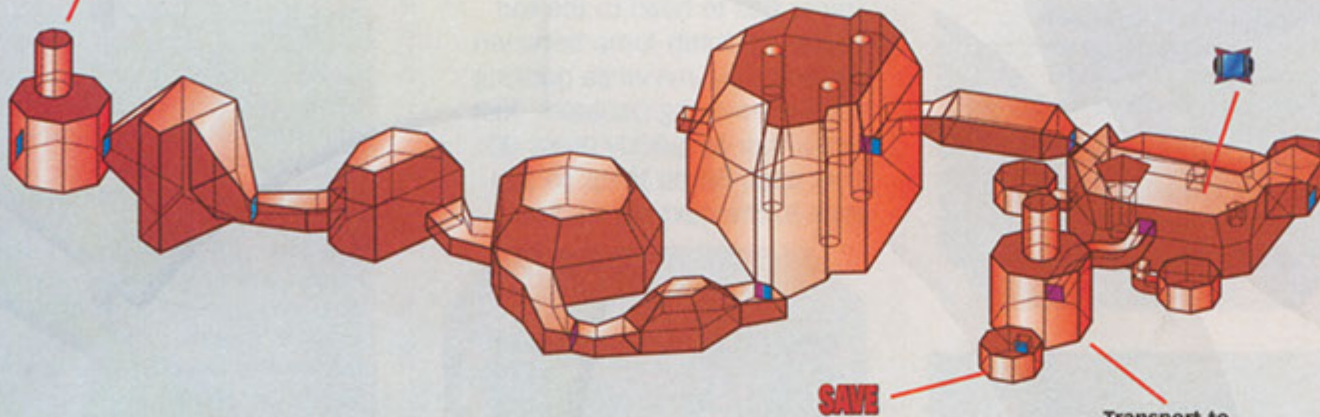

MAGMOOR SECTION 04 MAP

Puddle Spore



These clamlike beasts are indestructible, but they can be harmed. Shoot their cores to cause them to clam up and flip over. While they're upside down, they make excellent platforms for crossing lava. When they aren't flipped over, they can shoot globs of poison at you, though their attack isn't much of a threat.

PASSAGE FROM MAGMOOR CAVERNS TO CHOZO RUINS



When you arrive in Magmoor Caverns, you find a Save Station right next to the Transport. You may want to use it before heading out.



As you leave the Transport, you enter Magmoor Workstation. Several Flying Pirates attack as you go through the door. Stay in the tunnel and pick them off.



At the bottom of the room you find a puzzle. Inspect the machinery to the side, and you'll see that it lacks power. Use your Thermal Vision to find three nearby power conduits, one near each door, and blast them with the Wave Beam to restore the power.



Charging the power conduits causes one of the three small doors around the perimeter to open, and the lava leading to it cools. Switch to Morph Ball mode and drop into the caged pit. Be sure to eliminate the Triclops in the pit before exploring the cooled lava channel.



Roll into the room at the end of the channel and scan the screen on the wall. This cools another channel. Quickly dart back through the center to the second channel and scan the wall of the next room. Time is ticking away. This opens the last of the rooms. Dart into the third room and grab the Energy Tank.



Head into the South Cave Tunnel and blast the Puddle Spore to create a platform that allows you to reach the Geothermal Core. Head forward through Twin Fires and all the way to the Transport to Tallon Overworld West or Chozo Ruins North.

The Wavebuster, Artifact of Wild, and More

If this is your first trip back to Chozo Ruins since going to Magmoor, there's an awful lot to do before moving forward. All of those upgrades you've collected allow you to find lots of minor upgrades scattered throughout the area. All of these actions are optional, so if you don't feel like running around, you can skip ahead to the next section.



We'll start in Main Plaza of Chozo Ruins. Look for a half pipe in the center. If you look under the bridge above the half pipe, you'll see a Missile Expansion. Use your Morph Ball and Boost Ball to reach it.





Next, climb up to the bridge. Look off to the side to see a small awning over the door to the Ruined Shrine. Jump to the awning and then check out the huge tree. Blast the knot with a Super Missile to reveal a Missile Expansion. You can double jump from the awning to the upgrade.



Head to the Ruined Shrine. There's another half pipe in the center of the room. One side leads to a Missile Expansion and the other leads to a magnetic rail. Use the rail to reach the door above the room, which leads to the Tower of Light.



At the top of the Tower of Light sits the Wave Beam Combo (Wavebuster). To get it, you need a large supply of missiles. Hop up the platforms in the center as high as you can go. At that point you see cracked areas along the outer wall. Use three missiles to destroy each section. When you do, the entire tower collapses a bit, and you'll be able to climb higher. You must jump to the next set of platforms quickly though, because Plated Puffers enter the room and try to knock you off of the platforms.

Plated Puffer



These creatures are simply a much stronger version of the Puffer. They can take a beating, and their poison is even more toxic. It's best just to avoid them, or pick them apart from long range.



Keep working your way up the tower by destroying the cracked walls. When you get to the very top, you get the Wavebuster. It allows you to fire a nonstop beam of electrical energy that rapidly destroys any nearby creatures. Give it a try by charging your Wave Beam and pressing **○**.



Your next stop should be the Sun Tower. There's a magnetic rail that runs up the tower, but the way is blocked. You must find four symbols to clear the path. Check for two of the symbols on the pillars near the top. The other two are under the Cordite decorations on the walls. Destroy them with Super Missiles.



When the way is clear, use the Spider Ball to head to the top. You must Bomb Jump between pieces of the rail while dodging the slow-moving Oculuses. Just remember to quickly press **□** after each Bomb Jump so you stick to the next rail section.

Oculus

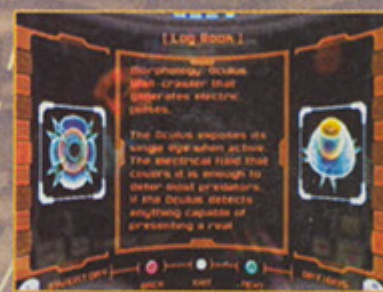

Although very slow-moving and nonthreatening, these creatures can still cause lots of trouble. They're often placed in areas where you must sneak past them in order to reach your goal. They may not look tough, but they're indestructible and electrically charged. Just don't touch them. Don't bother them, and hopefully they won't bother you.



Upon reaching the top of Sun Tower, follow the hall back to the Sunchamber where you battled Flaahgra. Three Chozo Ghosts attack as you enter the room. Use your Power Beam to pick them off, and the Artifact of Wild will appear where Flaahgra once stood.

Chozo Ghost



The spirits have become restless and have begun to defend the ruins from the Space Pirate invasion. Unfortunately, they don't distinguish between friends and enemies, so you'll have to fight them as well. Chozo Ghosts are completely immune to all attacks except for the Power Beam. They also have the ability to become invisible when not shooting at you. Later you'll be able to keep your eyes on them by using the X-ray Visor, but for now you just have to try to target them as they appear.



Continue to the Arboretum and then back to the Ruined Fountain. Since Flaahgra has been destroyed, the fountain is no longer toxic. Hop in and enter Morph Ball mode. The waters shoot you to the ceiling. Press **□** to grab on to the magnetic rail and follow it to find a Missile Expansion.



Go to the Gathering Hall. Climb to the top and jump onto the ledge over the door leading to Energy Core. Use a Morph Ball Bomb to destroy the grate blocking the Missile Expansion.



Travel to Watery Hall, where you found the Charge Beam. Near the Eyons, you find a blocked Morph Ball passage. Destroy the obstruction with a bomb, then follow the hall to the Dynamo. If you came here earlier, you already have one of two Missile Expansions in this room. If not, destroy the metal grate on the wall to get the first, then follow the magnetic rail to reach the second.

That's all you can do in the areas you've explored previously, but there's plenty more to do in Chozo Ruins. Head over to the Energy Core and into the Furnace room.

The Ice Beam



You'll remember the Furnace from before; it's where you got one of your Energy Tanks. This time you'll use the magnetic rail rather than the tunnel below to go up. Getting through the tunnel requires speed. The blocks in the tunnel disappear shortly after you touch them. Boost across them and quickly use a Morph Ball Bomb to reach the ledge in the center. Then boost across the second set into the large portion of the Furnace.



You can't do anything in the Furnace just yet, so head into the tunnel to the left to reach the Crossway. Cross the half pipe and destroy the Cordite decoration on the far wall. This causes a magnetic rail to appear over the half pipe.



Drop into the half pipe and use the Boost Ball to reach the magnetic rail. Follow the rail to a Morph Ball slot. Set off a bomb to make a second magnetic rail appear. Drop back to the half pipe and use the Boost Ball again to reach the next rail and Morph Ball slot. Once you activate the second slot, quickly drop to the ground and enter the shaft that opened. The shaft lifts you up to a Missile Expansion above the room.



Go through the Crossway to the Hall of the Elders. There's a Missile Station through the small tunnel to your left. If you aren't already at maximum capacity, use it.



Drop down to the floor, where you must defeat a Chozo Ghost. Once it's gone, the Chozo statue's hands light up. Leap up into the statue's hand and switch to Morph Ball mode. The statue tosses you like a bowling ball. Quickly hold **R** to stick to a magnetic rail on the room's side that leads to a Morph Ball slot. Activate the slot to reveal three colored Morph Ball slots on the opposite side of the room.

- Missile Expansion
- Charge Beam
- Energy Tank
- Morph Ball Bomb
- SAVE** Save Station

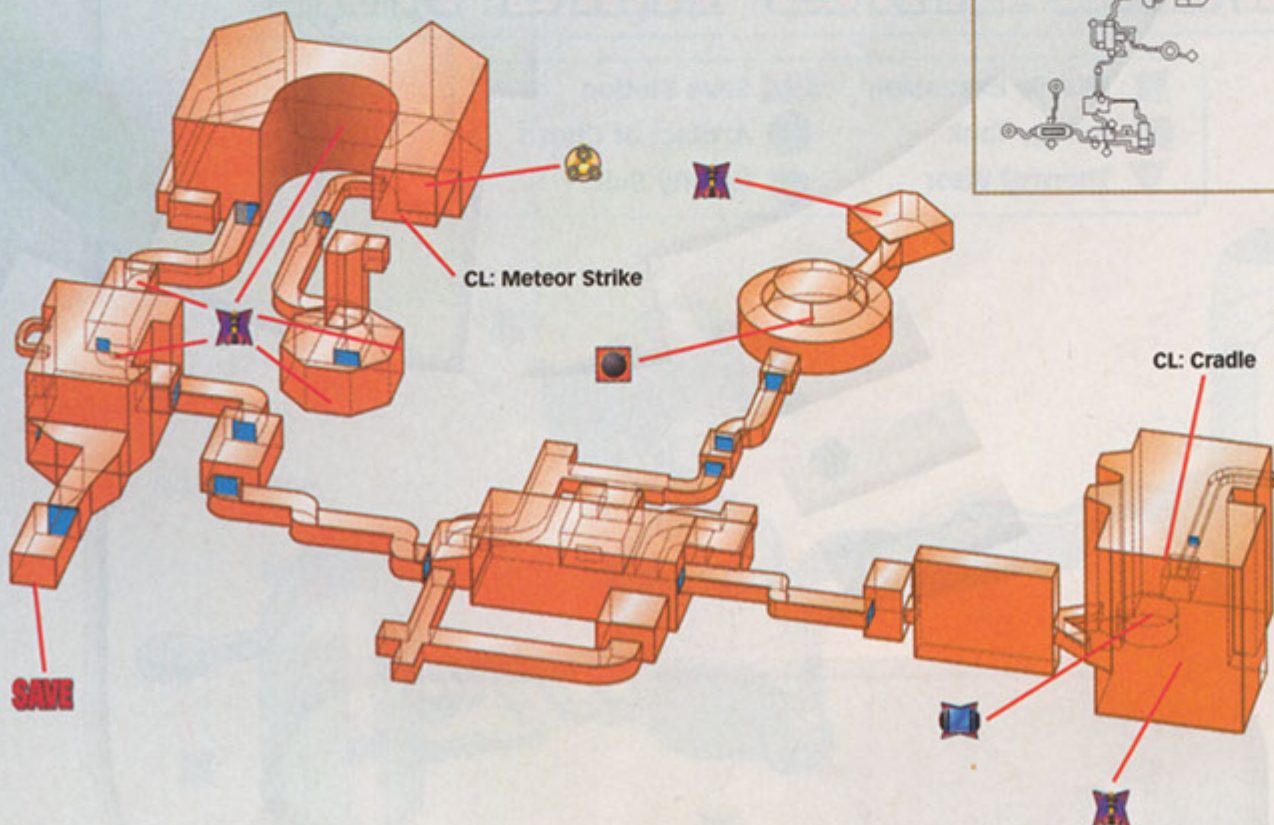
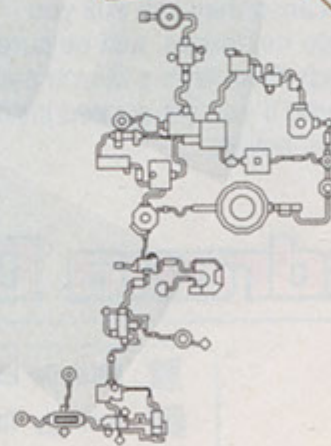

CHOZO SECTION 04 MAP



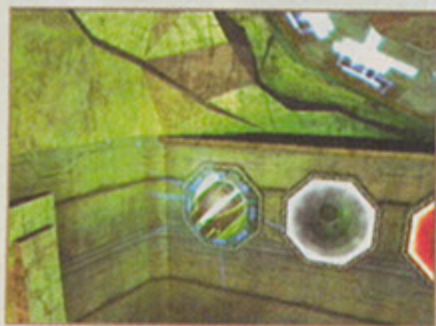

The colored Morph Ball slots change where the Chozo statue tosses you when you leap into its grip. Go up to the colored slots, blast the purple slot with your Wave Beam, then activate it. Go back down to the statue and hop into its cupped hands. This time, it tosses you up to a ledge along the side of the room. The ledge takes you to a small room that overlooks the Hall of the Elders. Use the switch in the side to deactivate the force field blocking the window so you can get through it later.



Enter the Reflecting Pool area. Drop into the water in the center of the room and destroy the cover on the drain with a Morph Ball Bomb. Once the water is gone, you can use the pool as a half pipe.



Use the Boost Ball to reach the top ledge. The Stone Toads can actually make this much easier, because they can pull you onto the ledges. Just be sure to blast them with a Morph Ball Bomb if you get sucked inside their bellies.



Enter the Antechamber to find the Ice Beam. This powerful beam weapon can freeze your targets. Once a target is frozen, shooting it with a missile shatters it.



Return to the Hall of the Elders. Defeat the Chozo Ghosts and use the Ice Beam Morph Ball slot to alter the Chozo statue's bowling path again. This time it will toss you into a room containing an Energy Tank.



You're ready to head back to Phendrana Drifts. Use the Transport to Tallon Overworld East, and you'll be able to pick up another Missile Expansion in the Overgrown Canyon as you head back to your ship. You can then use the Transport to Phendrana Drifts South in Magmoor Canyon to go to your next destination.



Phendrana Drifts Third Visit

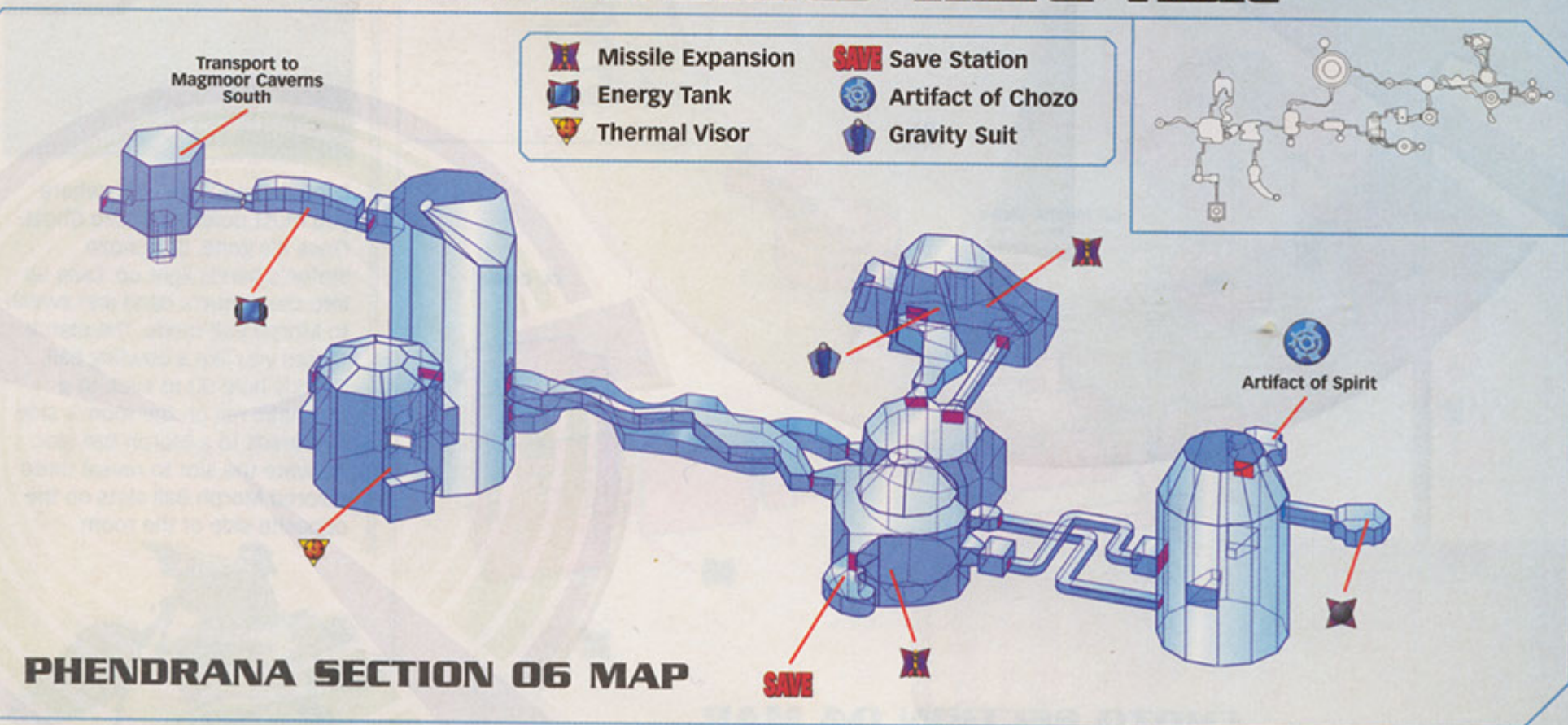

THE GRAVITY SUIT



When you arrive in Phendrana Drifts, head up the magnetic rail in Transport to Magmoor Caverns South to reach Transport Access. You notice an Energy Tank that's been frozen into an ice wall in this hallway. As much as you may want it, you won't be able to collect it until you have the Plasma Beam later on. Just make a mental note of it for now.



Enter Frozen Pike. That Ice Beam door halfway down this room takes you back to Research Core, where you found the Thermal Visor, so ignore it and drop to the second Wave Beam door from the bottom. You cannot reach the lowest door for the moment.



You are in Frost Cave. Eliminate the Hunter Metroid by using Ice Beam and a missile, then take aim at the stalactites. There are three, but you can shoot only the two lowest ones. They create steps so you can reach Save Station C and Upper Edge Tunnel. Visit the Save Station first, then move on to Phendrana's Edge through Upper Edge Tunnel.

Hunter Metroid



This creature is the next step in Metroid evolution. Rather than clinging to your head, they have the ability to drain your energy by attaching a tentacle to your body. They also like to ram into you. If a Hunter Metroid attaches itself to you, just shoot it to make it release. To defeat them, freeze them with your Ice Beam and shatter them with a follow-up missile.

Glider



These silent flying creatures are completely harmless. They just circle in the air without giving you a second thought. What makes them unusual is that you can attach to them with your Grapple Beam as if they were Grapple Points. Until you have the Grapple Beam, just ignore them.



There's nothing to do for now in Phendrana's Edge other than go to the next door, which takes you to Hunter Cave. Just drop into the water and be ready to fight off a couple of Jelzaps, then make your way through the underwater door.

Jelzap



Jelzaps have an unusual body that's made from two halves. Their weak point is the core between the two parts, which is only visible when the Jelzap attacks. Lock on to the enemy and wait for it to open. It will begin to pull you toward it. As it does, blast its core with a Charge Beam shot to destroy it.



Stay on the ledge as you enter Hunter Cave and shoot a missile into the three stalactites. These create steps across the water and allow you to reach the door on the right. If you fall into the water, you must climb out along the shore. Take down the Flickerbats zooming around near the water to avoid being pushed off.



You arrive in the Gravity Chamber, where the Gravity Suit is held. Reaching it is tricky, because you can't see very well and Aqua Reapers lurk along the water's bottom. Pass by the first set of Aqua Reapers and jump up the stairs behind them. Pass through the narrow hall to find a second set of Aqua Reapers. Work past them to find a small ledge where the Gravity Suit sits inside a wall.

Aqua Reaper



Aqua Reapers are close cousins to the Reapers found in Chozo Ruins. Though they can't be destroyed, shooting them near the tip of their tentacles causes them to withdraw temporarily. Blast them with whatever you've got and pass by quickly before they can recover.



The Gravity Suit allows you to move around in water as if you were on dry land. It also reduces the haze, making it much easier to see underwater. Put the Gravity Suit to use and jump out of the water to the dry room above. Head through the upper door back to Hunter Cave and stay on the ledge to reach the door just to the right. Climb back up Frozen Pike and make your way back to Transport to Magmoor Caverns South, and then head back to your ship in Tallon Overworld at the Landing Site.



Tallon Overworld Third Visit

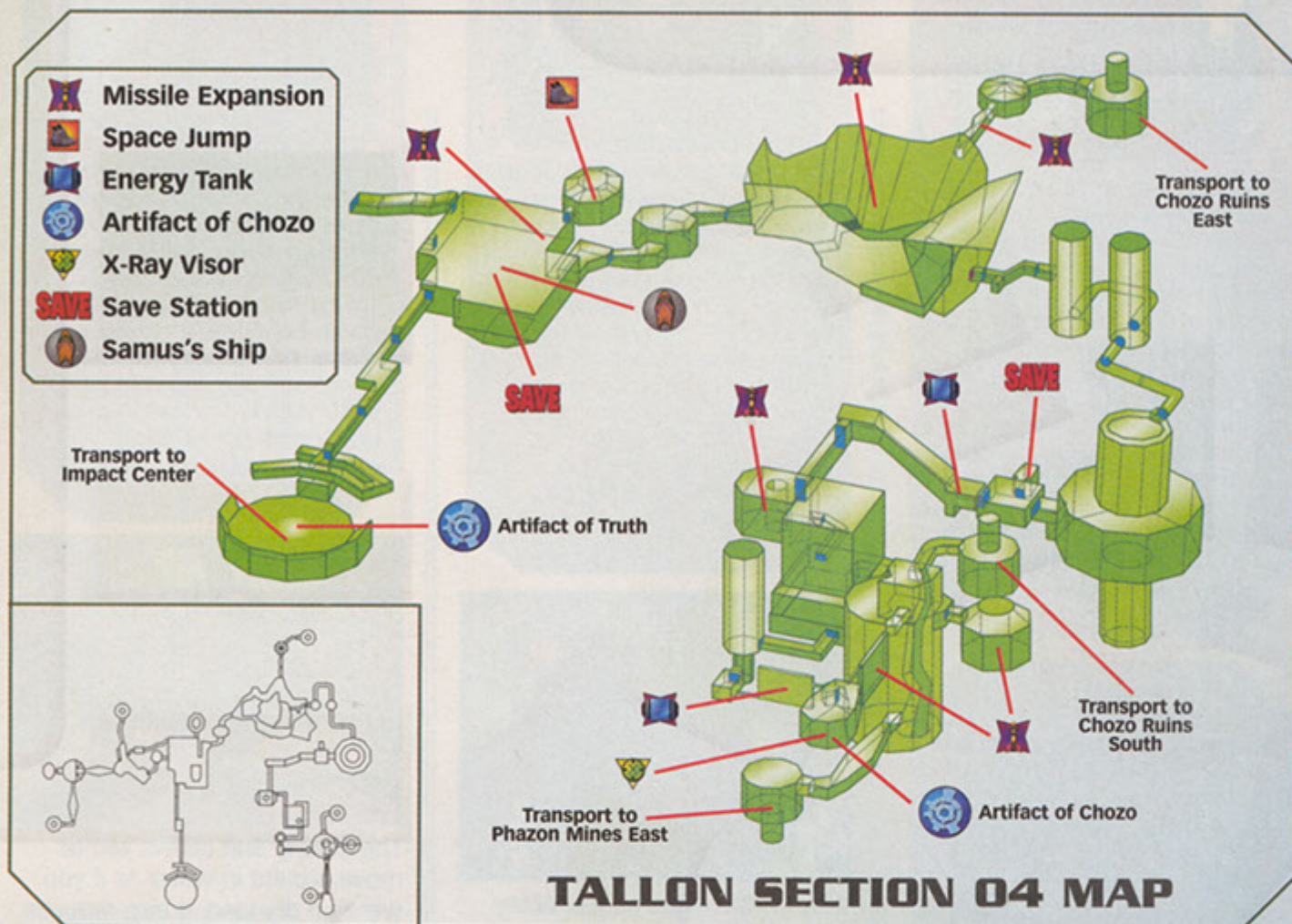

Follow the hall to the Reactor Core. Drop all the way to the very bottom and be ready to blast a couple of Aqua Pirates. Use your Thermal Visor to scan the area and look for three power conduits near the floor. Shoot each with your Wave Beam, then jump up the platforms to the door above. If you have trouble locating the door, use your Thermal Visor and follow the energy trails from the activated conduits.

PASSAGE TO PHAZON MINES



From Samus's ship, look around to spot a small pond. To its left is a passage that leads back to the Space Pirate Frigate's crash site. You must pass through the crashed frigate to reach Phazon Mines.



Dive into the water and climb onto the roots in the center. Look to your left to see a small alcove containing a Missile Expansion. Double jump from the roots to the alcove.



Drop back down to the bottom of the pond and look left to find steps up the opposite side. Climb up and go through the cave in the wall to reach a spot where you can return to dry land and the entrance to the Space Pirate Frigate.



The frigate is nearly entirely submerged, so it's a good thing you have the Gravity Suit, or you wouldn't be able to move around. Follow the hall to the Main Ventilation Shaft Section C. Destroy the Auto Defense Turrets, then use your Thermal Visor to scan the wall above the door, where you see a power conduit. Shoot it with your Wave Beam to restore power to the door and open it.

Aqua Pirate



Aqua Pirates are much like Flying Pirates, except they're able to move about in water. Blast them with your Ice Beam to freeze them, then finish them off with a missile.



Tallon Crab



These creatures act a lot like Parasites. They cover entire areas in a massive swarm, but they aren't hostile toward you. If you walk on them, you'll take damage, but it's negligible. Blast a path through them and quickly pass before they can regroup.



When you reach the door, use the Thermal Visor to inspect the wall on the left and find the fourth power conduit. Blast it and move on to Reactor Access, where you find a Save Station.



The door in Reactor Access is also locked down because of a lack of power. Use your Thermal Visor to find the two power conduits in the walls and reactivate them with the Wave Beam to access the Cargo Freight Lift to Deck Gamma.



The lift is smashed. Blast the lift's door with your Charge Beam and look inside to find an Energy Tank.



You must climb up the lift's shaft by jumping from platform to platform. Aqua Reapers block the path. Blast them and move by quickly. On your way up, you must find three power conduits in the walls. The first is on the side of the broken lift. The second is in the ceiling above the lift. The last is at the very top next to the door out.



Head through the door to the Biohazard Containment area. Somehow, two Auto Defense Turrets still function here. Blast them, then look for two power conduits on this floor. One is near where you entered, and the second is near the drop to the bottom floor.



Dropping to the bottom, you are assaulted by two Aqua Drones. Eliminate them with your Wave Beam, then look for a third power conduit in the containment chambers along the side. Also be sure to use your Scan Visor to inspect the closed chambers. One can be destroyed with a Super Missile, and you can find a Missile Expansion inside.

Aqua Drone



Aqua Drones are just like their dry land twins, Sentry Drones. Upon detecting an enemy, they lock all doors to prevent any escape and fight until their quarry is captured or they're destroyed. Use your Wave Beam to short out their circuits in a hurry.



Head on to the Biotech Research Area. Defeat the Aqua Pirates in the room, then use your Thermal Visor to look for power conduits. There's one on the ledge where you enter and one directly below it. The last is on the opposite wall below the door.



Drop to the bottom of the Connection Elevator to Deck Beta and head to the Hydro Access Tunnel. This is the first time you get to perform a Bomb Jump while underwater. Use a Bomb Jump to go over the first obstacle. When you drop back to the floor, hold up a second; an Energy Tank hides overhead. To reach it, you must perform an underwater Double Bomb Jump.

Aqua Sac



These are similar to Sap Sacs found in Tallon Overworld and Chozo Ruins. When shot, they break into multiple explosive fragments. Aqua Sacs are deadly if you run in to them, so keep your distance. You can usually just ignore them, but be sure to scan them for your Log Book.



Lay a bomb and let it propel you up. As your momentum slows, quickly drop another bomb. If you time it right, the second bomb will propel you up farther. Drop a third bomb as your momentum slows again, and you should be blasted high enough to reach the Energy Tank on your left. Continue through the passage to reach the Great Tree Hall.



Head up the roots to reach the Ice Door above, which leads to the Transport to Phazon Mines East and your next big challenge.

TIP

You can explore the Great Tree Hall further, but there's really no reason to do so right now. You'll be back here shortly.

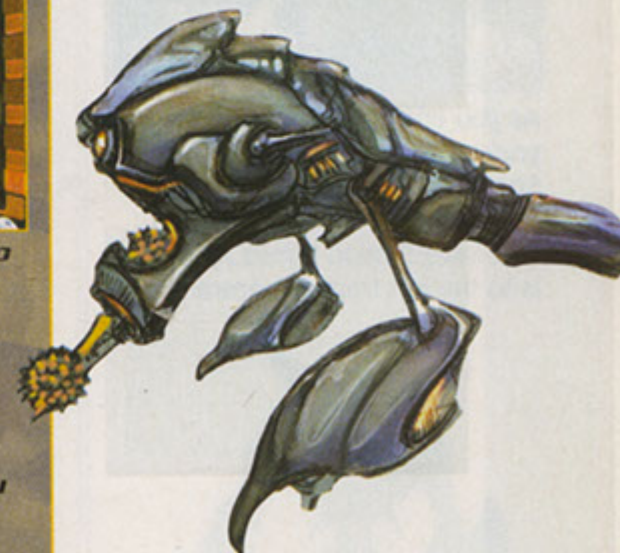

Phazon Mines First Visit

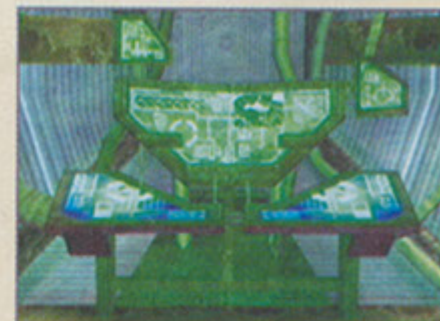
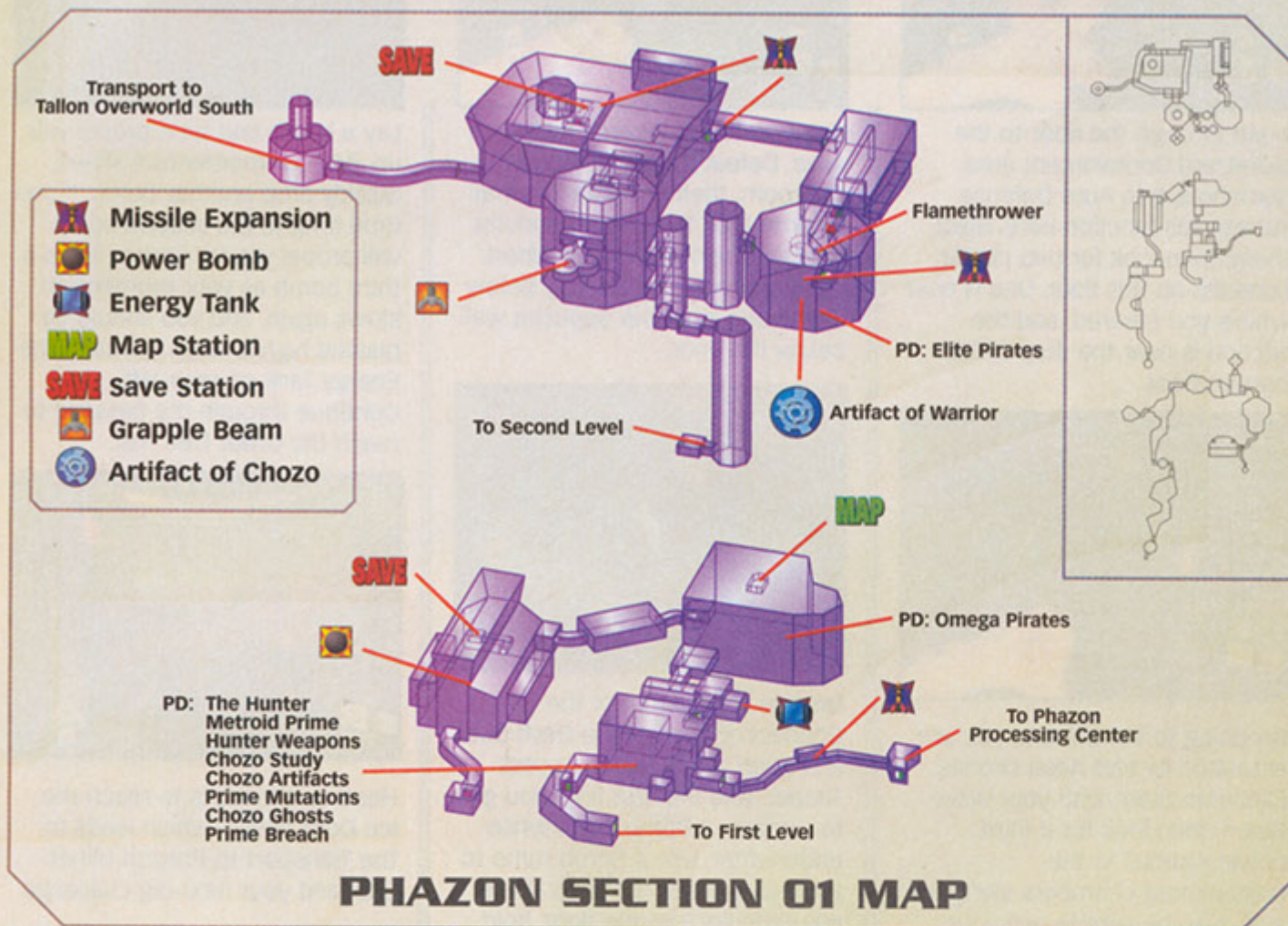

Before deactivating the force field, find the stairs up and climb to the top of the structure in the center where the crane sits. At the top, look for a power conduit on the crane's base by using your Thermal Visor. Blast the conduit with your Wave Beam, then enter the control booth to the side. Activate the controls to realign the crane. Go to the crane's base and use your Morph Ball and Spider Ball to run along the crane to a small ledge containing a Missile Expansion.



Drop back to the ground and look for two control panels near the force field. Scan them both to drop the force field, then head into Security Access A.



Continue into Mine Security Station. Switch to Thermal Visor and be ready for several Shadow Pirates to attack. Once they're gone, follow the hall and go up the ramp to the top floor, where you are attacked by an entirely new type of Space Pirate known as a Wave Trooper. Use your Wave Beam to destroy them; no other weapon will work.

THE POWER BOMB



As you enter the Main Quarry, you are faced with multiple Space Pirates. Pick them off one at a time from a distance, then visit Save Station Mines A, which is to the left from the entrance.



To the side of the area, you see a large force field blocking your path. There are also Mega Turrets above the passage; these are much stronger versions of the Auto Defense Turret. Eliminate them with the Wave Beam from a distance and use the pillars for cover.

TIP

If you take a lot of damage from the Mega Turrets, you should go back to the Save Station to restore your health. Phazon Mines is a very dangerous area, and you'll need all of the energy you can get.

Mega Turret



These are reinforced Auto Defense Turrets with much stronger firepower. You don't want to take on these turrets face-to-face. The powerful shots can rip you to shreds before you even know what's going on. Find cover and strafe back and forth while blasting Mega Turrets with your Wave Beam. Watch out; when they're about to be destroyed, they'll go haywire and begin firing in all directions. Find a safe spot and wait out the storm.



Wave Trooper



Wave Troopers are enhanced Space Pirates. The Space Pirates have begun to reverse engineer your weaponry in hopes of finding a way to bring you to your knees. This one uses a modified Wave Beam gun and can be distinguished from other Troopers by the purple lines on its armor. The Wave Beam is the only weapon that's effective against them. Charge a Wave Beam blast and shoot them. The blast stuns them temporarily. Quickly charge about two more shots halfway and blast again to defeat them; this tactic prevents them from returning fire.



Defeat the Wave and Power Troopers on the second level, then find the next switch to reach the top floor. There you see a gigantic laser used for mining purposes. To its side are a Spinner device and a computer console. The console allows you to activate the laser, and the Spinner lets you adjust the laser's position.



Power Trooper



These foes are yet another form of enhanced Space Pirate. This version uses a modified Power Beam and is distinguished by yellow lines on its armor. Its only weakness is your Power Beam, which makes it one of the toughest Troopers to defeat. Rather than having a shooting match, quickly charge a shot and use your Super Missiles to destroy them. Peppering them with shots from your Power Beam takes too long and leaves you extremely vulnerable. It's best to use the five missiles required for a Super Missile than to take a lot of unnecessary damage.



You must fire the giant laser twice. First adjust the laser so it's pointing across from the control booth. Blast the wall to reveal the exit. Then adjust the laser so it's pointing at the middle wall on the left. Destroy the wall to find a Missile Expansion.



Pass through the door and on to the Ore Processing site. In the center of the room is a huge column made of three parts with magnetic rails running along the side. You must adjust the pillar's alignment so you can reach the balconies above.



Find the control panel on the bottom floor and Bomb Jump into the Morph Ball slot. Set off a single bomb to align the pillar with the first balcony. Use the Spider Ball upgrade to roll up the blue magnetic rail to the balcony and the next control panel.



Enter the second control panel and set off two bombs to align the red magnetic rail with the third balcony. Drop back to the bottom control panel and set off three bombs to align the bottom portion with the middle portion. Ride the red magnetic rail up to reach the door to Elevator A.



Elevator A takes you to Phazon Mines Level Two. In the Elite Control Access hallway, notice a vent spewing toxic gas. Blast the explosive crate next to the vent to destroy the vent and expose a Missile Expansion. Double jump to the ledge and use your Morph Ball to pick it up.



Next you enter the Elite Control area. As you enter the room, a huge Elite Pirate attacks you. Dodge its wave attacks by double jumping, and shoot it in the head with a charged shot.



Head through the Ice Beam door at the end to reach the Elite Research area. Check the consoles to find a switch that aligns several platforms so you can jump up to the next level.

TIP

The research areas in Phazon Mines hold lots of Pirate Data, just like the research areas in Phendrana Drifts. Be sure to scan all the computers you see to fill your Log Book.

Elite Pirate



Space Pirate research into Phazon applications resulted in Elite Pirates. They attack with an electric wave by slamming their fists into the ground. When they aren't attacking, they hold their left hand out to absorb any beam weapon attacks. Double jump over their wave attacks and quickly blast them in the face with a Charge Beam while their defense is down. These are really easy battles once you get the timing down.





An Ice Trooper attacks after you head up the walkway to the floor above. Use your Ice Beam to defeat it. Be sure to check the computers. There's lots of Pirate Data to be found.

Ice Trooper



Ice Troopers are the third enhanced Space Pirate you encounter. They use a modified version of your Ice Beam and are distinguished by white lines on their armor. They're extremely weak against your Ice Beam, but no other weapon can harm them. Blast them with a charged Ice Beam shot, then use a missile to shatter them. When fighting a single Ice Trooper, just use multiple Ice Beam blasts and save your missiles.

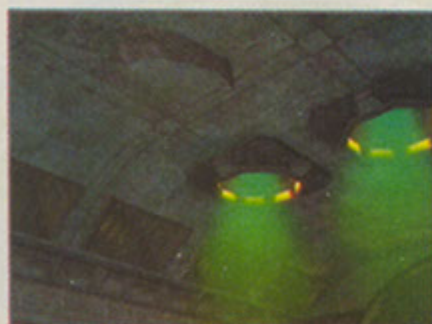

Head through the door at the top of Elite Control to reach the Ventilation Shaft. Pass through quickly, because the area is full of toxic gas.



This leads to the Omega Research section. Take down the Wave Troopers on the top floor, then pick off the Power Troopers on the floor below. Jump down and continue on to the Central Dynamo.



Drop to the floor, and a cloaked Sentry Drone attacks you. It's impossible to lock on to this enemy. Just watch for its lights, and manually aim at it with your Wave Beam. Keep blasting it as quickly as you can to destroy it. Because this enemy is cloaked, there's no way to scan it.

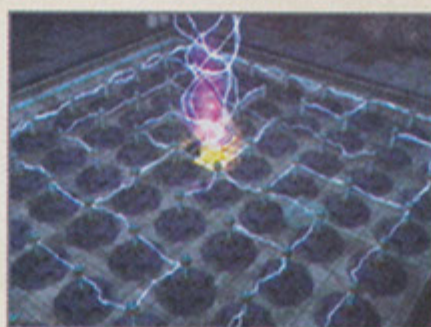

Once you destroy the Sentry Drone, a panel on the floor opens. Enter Morph Ball mode and drop through the hole to a maze of electrical currents. You must reach the center of the maze to get the Power Bomb upgrade.

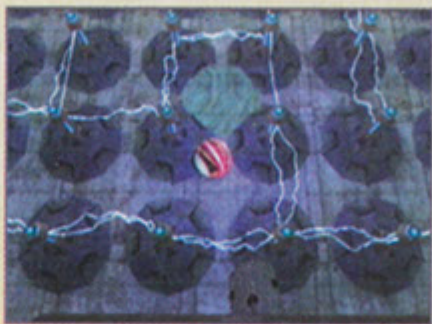

Avoid the electric walls and roll through the maze slowly; there's no need for haste. Some of the electric walls flicker. Wait for them to dissipate, then roll past. You also see pools of a volatile chemical. Don't roll into them or you'll take damage. Set a Morph

Ball Bomb next to the pools to destroy them, and the explosion will also destroy a part of the maze. When you get to the center, you gain the Power Bomb, which is able to destroy some of the toughest substances on the planet, such as Bendeziium.



You're automatically removed from the maze. Visit Save Station Mines B and get ready to head back up to the top to get your next upgrade.

TIP

You can go farther into the mines if you like, but there's no need at the moment. It's better to backtrack now and wait to explore the rest when you return later.

THE GRAPPLE BEAM

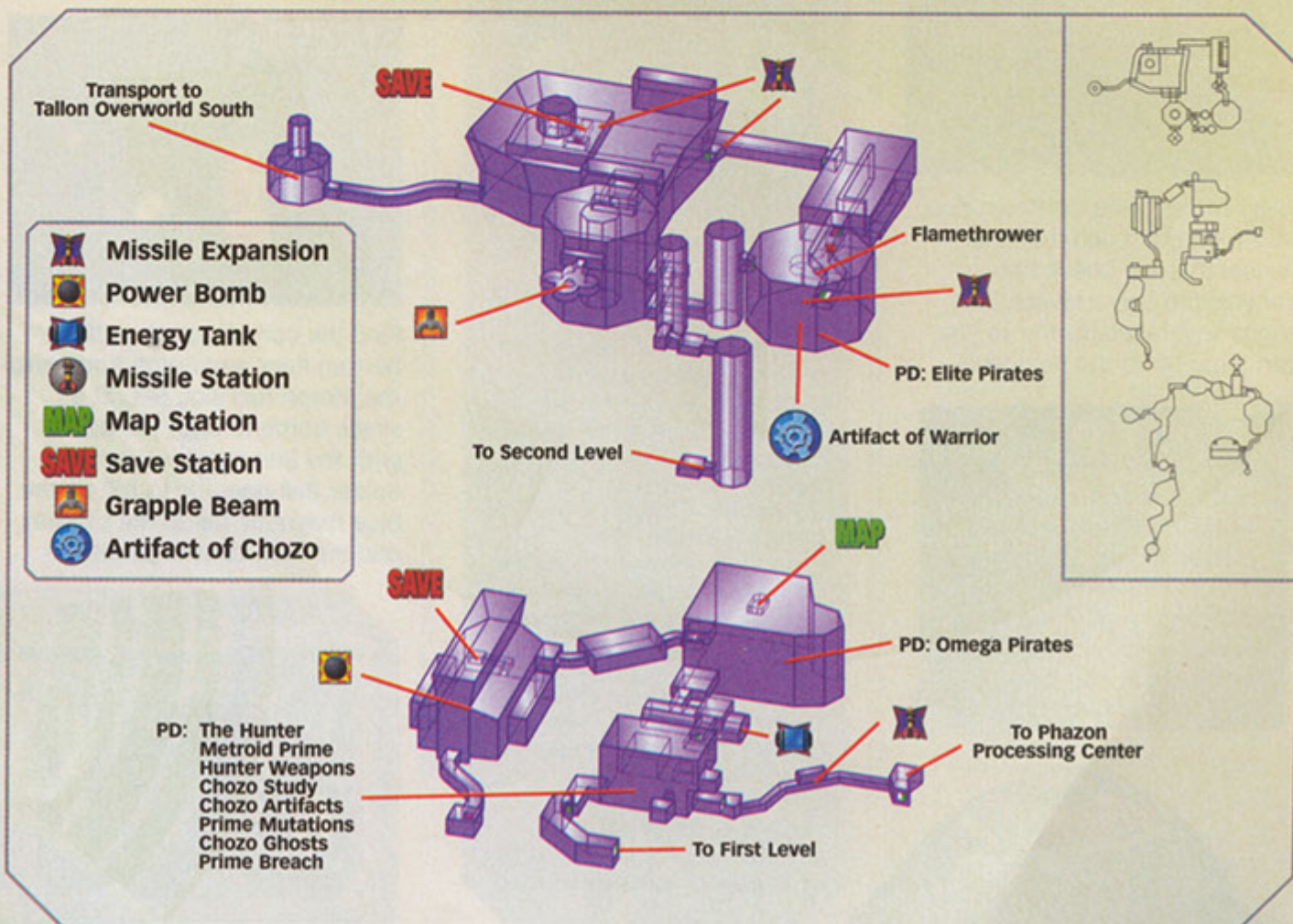

PHAZON SECTION 02 MAP



Use the platforms in the Central Dynamo to return back to the door that takes you to Omega Research. As you enter the area, you are forced to fight another Elite Pirate. Remember to jump its wave attack and blast it in the head with a charged shot.



At the top of the room, jump across the platforms and use a Power Bomb to clear the rubble blocking the Map Station, where you can get a good idea of how much remains to be explored in Phazon Mines, but that's for later.



Head back into the Ventilation Shaft. Quickly set off a Power Bomb in front of the nearest fan to open a passage. Drop in and go under the fan to find a switch that activates the fan. This clears the room of the toxic gas and reveals an Energy Tank.



Use your Boost Ball to reach the high door in the Ventilation Shaft and continue on to Elite Control. Be ready for some attacking Shadow Pirates as you enter the room and head back to Elevator A to return to the first floor of Phazon Mines.



Reenter the Ore Processing area. If you chose to visit Metroid Quarantine A, the area will be filled with Metroids, but your Ice Beam will allow you to destroy them with one shot and a missile. Clear the Metroids if you must and then prepare to realign the central column to reach the top floor.



First you must align the top section by double jumping over to the control panel on the floor where you enter. Use a Power Bomb to clear the rubble in front of the control panel, then set off two bombs in the Morph Ball slot to align the top section of the central column.



Drop to the balcony below. Set off three bombs in the control panel to align the middle section. Jump over the rail to the bottom floor and align the bottom section by setting off one bomb in the control panel. Use the yellow magnetic rail to reach the very top of the room and enter the door there to find the Grapple Beam.

TIP

The Grapple Beam allows you to attach to Grapple Points and swing back and forth as if on a rope. You can use this to cross large expanses. Press **[L]** to shoot the Grapple Beam at a Grapple Point, and release **[L]** to let go. You can adjust your direction while swinging if necessary.



Leave the room and use the Grapple Beam to swing across the top floor to the door on the opposite side. This takes you back to the Main Quarry so you can access the Transport to Tallon Overworld South.



Tallon Overworld Fourth Visit

TALLON SECTION 05 MAP

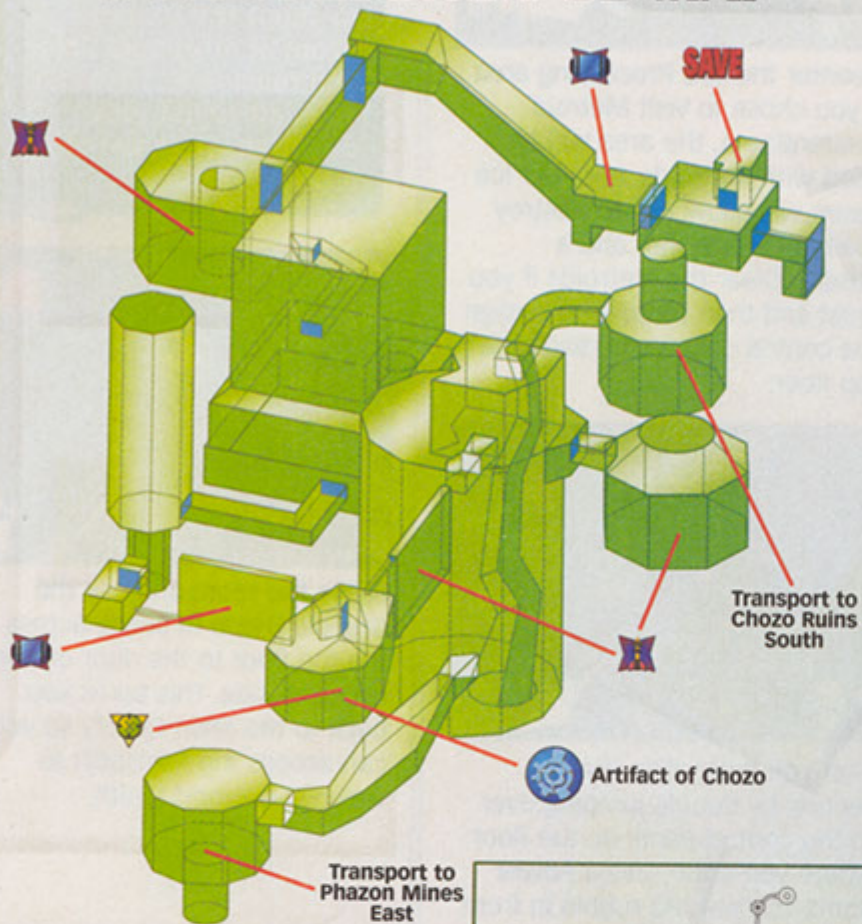

- Missile Expansion
- X-Ray Visor
- Energy Tank
- Artifact of Chozo
- Save Station

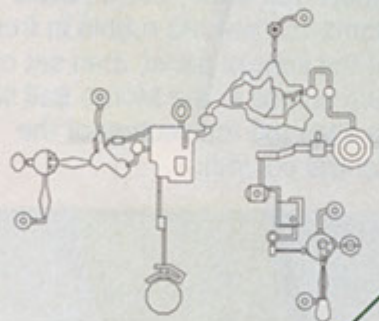

THE X-RAY VISOR AND ARTIFACT OF CHOZO



As you leave Phazon Mines, you arrive back in the Great Tree Hall, which happens to be right where you need to go. Jump up the platforms to find a Spinner device next to a metal gate. Use the Spinner to unlock the gate and continue up.



Above you is a twisting magnetic rail. Jump up to it and use the magnetic rail to reach the door above, which leads to the Life Grove Tunnel. Use a Power Bomb to destroy the large boulder in the tunnel, then roll into the unblocked passage.



You must use the Boost Ball to get through the tunnels. In the second half, use the Boost Ball to get on top of the large oval rock. Blast the top of the rock with a Morph Ball Bomb right in the center, then drop into the hole to find a Missile Expansion.



Continue through the passage into the Life Grove, and you find the X-ray Visor sitting on the ground. It allows you to see through breakable walls and floors. Try using it right away.



Notice that most of the walls in this area can be destroyed. Use a Power Bomb to destroy them, and you'll see that the Life Grove is much larger than it appeared.



Roll into the water at the back of the grove and destroy the small drain cap with a Morph Ball Bomb. This reveals a pillar with a Spinner at the bottom. Use the Spinner to set the bridge above so you can reach the Artifact of Chozo. Just double jump onto the bridge to collect the Artifact.



To exit the Life Grove you must climb a series of platforms along the outer edge. When you near the waterfall, three Chozo Ghosts attack you. Stay above the waterfall with your back to the wall, and you can defeat the ghosts pretty easily. When they're eliminated, the exit opens, which you can reach by continuing along the platforms.



Return to the Great Tree Hall and stand on the ledge where the Bloodflower sits. Use your X-ray Visor to see a hidden platform in front of you. Jump over to it and look to the side to see a door through the tree leading to a Missile Expansion. The jump from the hidden platform to the door is a long double jump, but it can be done. Now it's time to head down to Magmoor Caverns for one last visit.



Magmoor Caverns Fourth Visit

THE ARTIFACT OF NATURE AND THE ICE SPREADER



You're almost fully powered now, but there are a couple more major upgrades and a lot of minor upgrades to find before you're ready to head back into Phazon Mines. We begin in Lava Lake within Magmoor Caverns.



Get to Lava Lake and look for a large stone column in the center of the lake. There are two, but the one you want is on the Lake Tunnel side. Aim at the column and shoot it with a Super Missile. The column is destroyed to reveal the Artifact of Nature. Double jump over to the broken column to collect the Artifact.



Our next stop is the Triclops Pit, which is just a short walk away. Destroy the crates near the door to Pit Tunnel, then use your X-ray Visor. You see a long line of hidden platforms. Jump from platform to platform, and you'll find yourself looking directly at the pillar in the middle. Blast the pillar with a Super Missile to uncover a Missile Expansion, which you can get by using double jump.



Head to the Warrior Shrine above Monitor Station. In front of the Chozo statue is a metal plate on the ground. Destroy the plate with a Power Bomb to reveal a tunnel. Roll into the tunnel, which takes you to a room containing a Power Bomb Expansion.

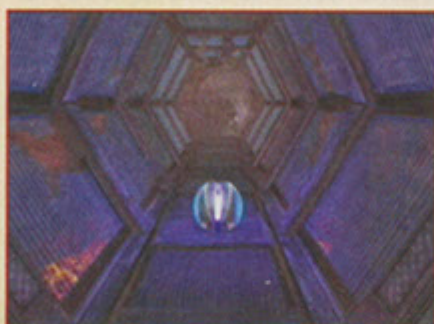

Go to Shore Tunnel. A large metal bridge here is slightly smashed up. Set off a Power Bomb in the middle of the bridge to destroy the sides. Drop down the rocks below to find the Ice Beam Combo (Ice Spreader). This combo freezes a large area and any enemies within it. It costs 10 missiles to use, but it's worth it in situations where you need to disable multiple enemies at the same time.

THE PLASMA BEAM



Continue on to the Geothermal Core. Notice that the Puddle Spores have left, so you must double jump across the lava. Make your way to the shore next to the South Core Tunnel exit.



A couple of small ledges are on the wall; jump onto them so you can use your Grapple Beam to swing onto the lowest of the three disks in the center of the room.



Enter the Spinner device in the disk's center and use it to raise the top disk until it locks into place. Double Jump to the next disk and use the Spinner device there to do the same. Double jump back to the top of the first disk and then to the third disk. Use the last Spinner device to lock the final disk into position.



Use the magnetic rail in the center of the third disk to reach the top, then double jump back to the top of the second disk. There you find a Morph Ball slot. Get into it, and set off a bomb, and the entire room undergoes a transformation.



A huge Morph Ball maze is uncovered. It looks daunting, but it's really very easy. Bomb Jump onto the magnetic rail near the Morph Ball slot and it takes you to the maze. Just follow the magnetic rails along the outside of the room while dodging the Plated Parasites.



Navigating the maze requires dropping from rail to rail and occasionally Bomb Jumps. When you need to dodge Plated Parasites, there's always plenty or room. You don't need to stay directly on the magnetic rails; the electrified walls will also hold you up.

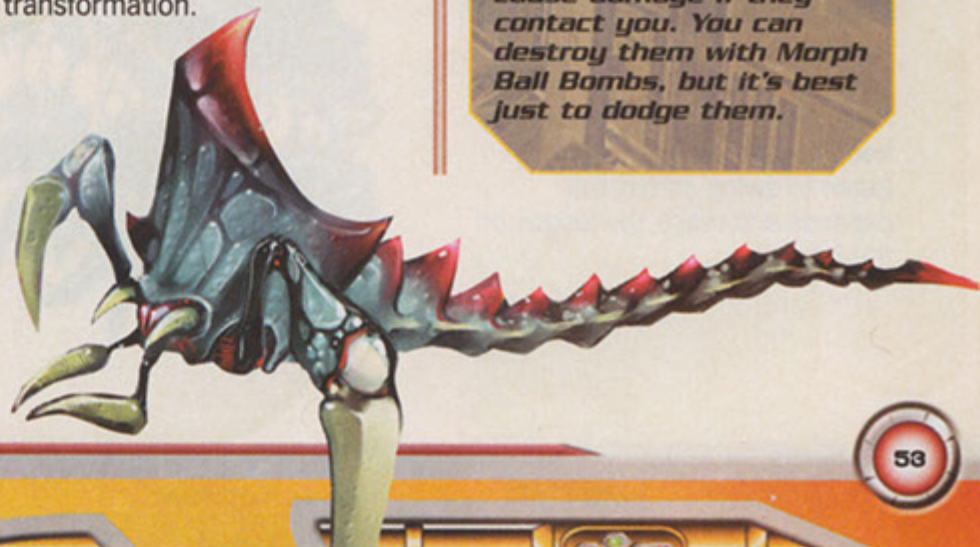



When you reach the top, go through the Ice Beam door and into Plasma Processing to find the Plasma Beam. This is the last of your beam weapon upgrades.

TIME TO UPGRADE

Now you have most of the major upgrades and you can access anywhere in Tallon Overworld, Chozo Ruins, and Phendrana Drifts. You should have already collected everything there is to offer in Magmoor Caverns, so there's no pressing need to return here except when traveling from place to place. Before you return to Phazon Mines, there are many minor upgrades to collect and all but one of the Chozo Artifacts. You don't have to collect everything if you don't feel like it, but it will make the coming battles much, much easier—and you do need to get all the Artifacts if you're ever going to finish the game.

Tallon Overworld



Go to the Root Cave in Tallon Overworld. Two upgrades are here. Climb to the ledge near the Root Tunnel. Use your Grapple Beam to swing across the expanse and reach the ledges on the far side.



When you get to where it seems you can't go any higher, use your X-ray Visor to see a row of hidden platforms. Begin jumping up, and you find a Missile Expansion in a small alcove near the top.



Continue on to the top and enter the Arbor Chamber to find the second Missile Expansion. That should be it for Tallon Overworld.

Chozo Ruins



Reenter Chozo Ruins and head for the Tower of Light. Drop into the water at the base of the tower and enter the tunnel there. Follow it to the end to find the Artifact of Lifegiver.

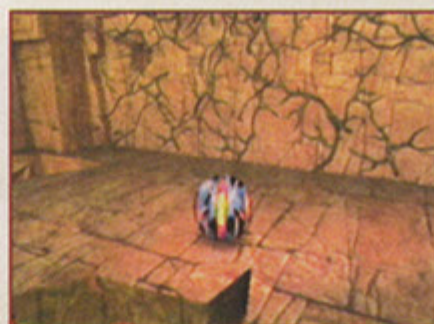

Return to the main area and go to the Ruined Fountain. Go through the door to the unexplored area, which is known as Magma Pool. Use the Grapple Beam to cross the pool, then destroy the wall at the opposite end with a Power Bomb to uncover a Power Bomb Expansion.



Enter the Training Chamber Access hall. Near the door to the Training Chamber, you see a tree. Enter Morph Ball mode and pass through the tree to find a hidden tunnel leading to a Missile Expansion.



Continue into the Training Chamber. Two Morph Ball slots are over the half pipe in the center. Use your Boost Ball to reach the slot on the right. This activates a small lift next to the half pipe. Quickly dart onto the lift and then use the magnetic rail to reach a room containing an Energy Tank.



Return to the half pipe and use the Boost Ball to reach the left Morph Ball slot. This opens the room's exit and allows you to return to the Main Plaza. Don't leap down to the ground; use the Grapple Beam to swing across the plaza and reach another Missile Expansion that's probably been taunting you since the beginning of the game.



The next stop is the Watery Hall. Enter the water in the middle of the room and look for a passage. Double jump up to the underwater alcove, where you find another Missile Expansion.



There's still plenty to do, so go to the Furnace room. Remember those magnetic rails on the ceiling? Use a Power Bomb to destroy the floor on the side of the room opposite the Chozo Lore. This reveals a half pipe which you can use to reach the magnetic rails. Follow the maze of rails to its end to get another Missile Expansion.



Go to the Hall of Elders with the bowling Chozo statue. Defeat the Chozo Ghosts, then climb up to the colored Morph Ball slots. Activate the red Plasma Beam slot, then hop into the statue's hands. This unlocks a chamber under the statue that contains the Artifact of World. With that, you're done with Chozo Ruins. It's time to return to Phendrana Drifts one last time.

TIP

Be sure to save your game soon. It's easy to forget while running around like this. You don't want to mess up and have to do all of this running again.



Next we enter the Chozo Ice Temple. Go to the frozen statue and blast it with your Plasma Beam. Hop into the hands as a Morph Ball to open a passage at the bottom. Follow the passage to find the Artifact of Sun.



Go to Ice Ruins East. Check the buildings near the Plaza Walkway to find a frozen section in a wall. Blast the ice on the wall to uncover a Missile Expansion.



The next stop is Ice Ruins West. Look for a frozen spot on the top of a building near a stack of crates. Blast the ice with the Plasma Beam and drop in the hole to find a Power Bomb Expansion.



Head to Quarantine Cave. Use the Grapple Beam to reach the far-off ledge and the Quarantine Monitor. Enter the room to find yet another Missile Expansion.



Venture down to Transport Access. You'll remember this frozen Energy Tank. Use the Plasma Beam to melt the ice and grab the upgrade.



Go to the Control Tower through the Pike Access tunnel. Look in the window above the East Tower to see a stack of crates in front of a frozen window. Destroy the crates and melt the ice. Look in the distance at the tower with a large fuel cell on the bottom. Destroy the fuel cell with a missile, and the tower collapses. Inspect the collapsed tower to find the Artifact of Elder.



Return to the Frost Cave. Use the Grapple Beam to attach to the Glider and swing over to the high ledge stacked with crates. From there you can shoot down the last stalactite with a missile. The stalactite busts the ice at the bottom, which allows you to reach a Missile Expansion in the water.



Continue on to Phendrana's Edge. Begin climbing to the top by using your Grapple Beam. As you near the middle, use the X-ray Visor to locate a hidden door behind the outer wall. Blast the area with a Power Bomb and enter the Storage Cave find the Artifact of Spirit.



Continue to the top of Phendrana's Edge to find a passage leading to a Power Bomb Expansion.



Your last stop is in the Gravity Chamber. Climb onto the ice above the water and look above you to see a ton of icicles hanging from the ceiling. Blast them with your Plasma Beam to reveal a Grapple Point. Use the Grapple Beam to swing across the room and reach a small ledge holding another Missile Expansion.

That was a lot of exploring, but you're now much stronger than before, and you have nearly all the Chozo Artifacts. Victory is near. Time to return to Phazon Mines for the last of your upgrades.



Phendrana Drifts



We begin in Phendrana Shorelines. Look behind the frozen column near Save Station B. You find a Missile Expansion trapped in ice. Blast the ice with your Plasma Beam to melt it.

Phazon Mines Second Visit

THE FLAMETHROWER, ARTIFACT OF WARRIOR, AND MORE



Upon your return to Phazon Mines, scour the areas you've already explored in order to find various upgrades you passed up earlier. Begin in Security Access A on the top floor. Detonate a Power Bomb in the area where the hallway turns to destroy a wall to reveal a Missile Expansion.



Next, visit the Mine Security Station. Go to the second floor and find the control booth blocked by a metal gate. Use a Power Bomb to destroy the gate, then scan the computer terminal to disable the force field on the floor below. Go back downstairs and enter the Plasma Beam door to find the Plasma Beam Combo (Flamethrower).



Continue on to the Elite Research area. There's an enemy named Phazon Elite in the vat at the bottom. Use a Power Bomb to

free the enemy, then defeat it in battle. This Elite Pirate is stronger than the others you've faced, but the strategy remains the same. Jump over its wave attacks, then blast it in the head while its defenses are lowered. The pattern is simple. Just try to keep your distance and don't get hung up on the equipment scattered around the room.



After you defeat Phazon Elite, the Artifact of Warrior appears in the center of the room.



You're ready to move on. Head down to the Central Dynamo, and then on to Metroid Quarantine A. The hall leading to Metroid Quarantine A has several Mega Turrets in the center. Enter Morph Ball mode and drop into the hole ahead and to the right. This allows you to pass beneath the floor and come out behind the turrets. Look for a switch on the opposite side that allows you to disable the guns.



As you enter Metroid Quarantine A, you see that the Space Pirates have a bunch of Metroids trapped behind a force field. Scan the console near the entrance to drop the field and watch the Metroids lay waste to the Space Pirates. Once they're done feasting, they'll come after you, so have your Ice Beam ready.

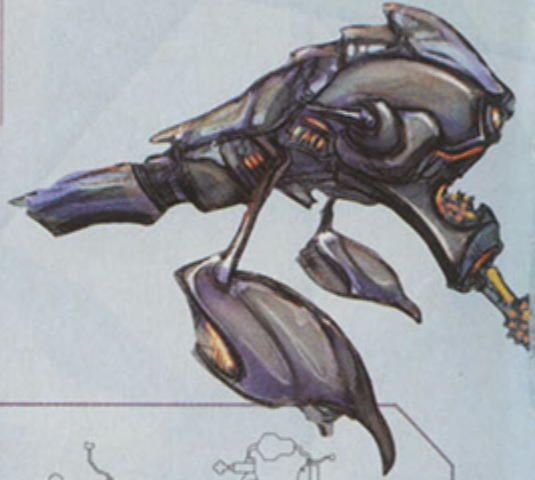

THE PHAZON SUIT

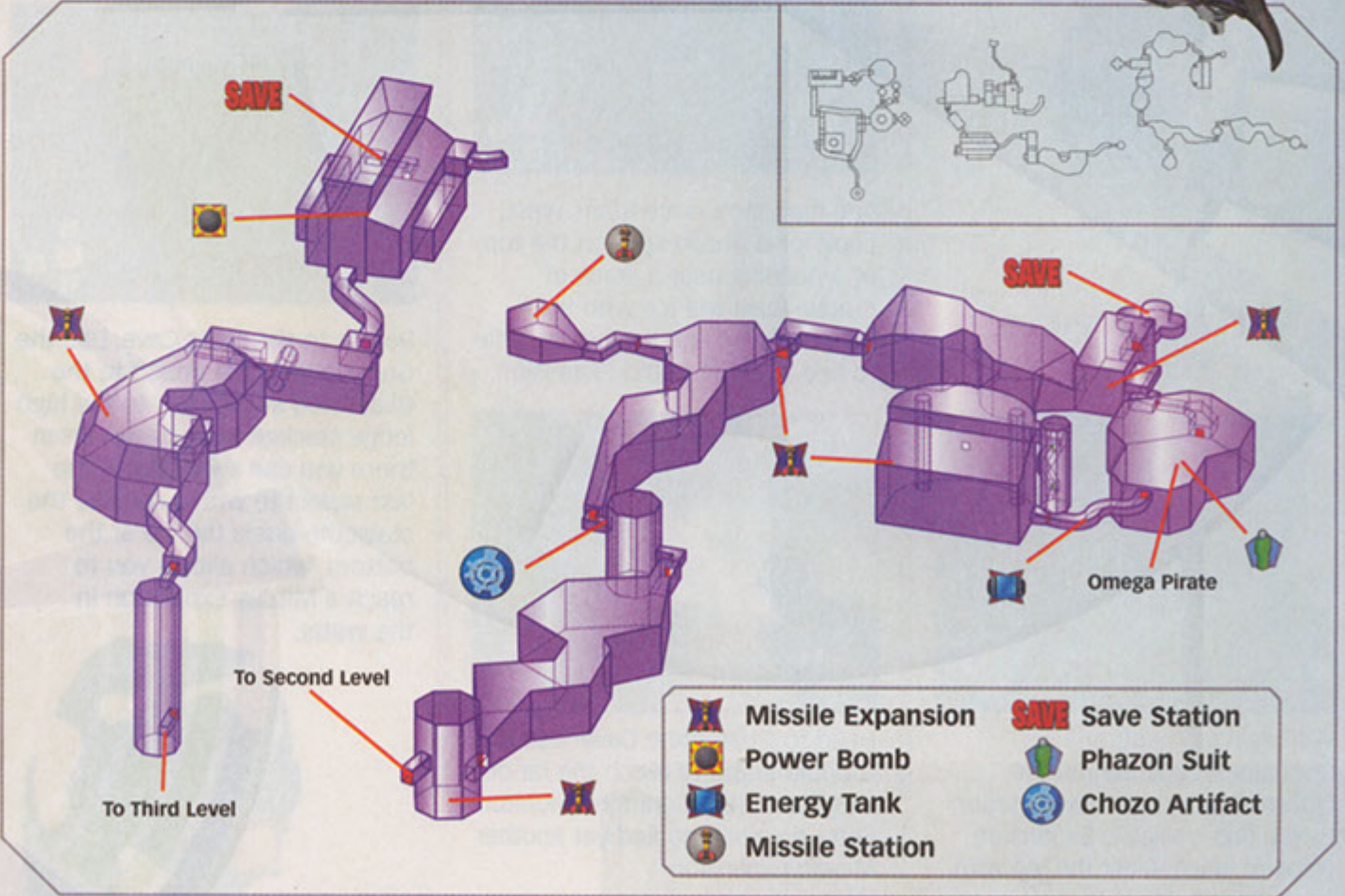

Phazon Section 03 Map



Enter the cave and avoid the blue material on the ground. This is Phazon. It's harmful to you in the same way that lava rapidly reduces your health.

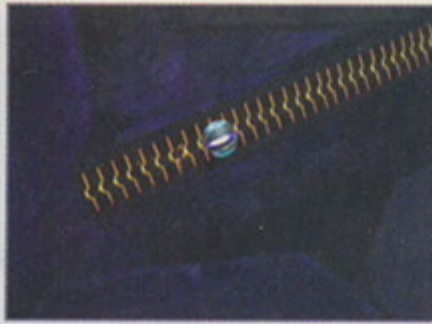

Jump over to the diagonal magnetic rail and ride it to the top. Follow the hall to Elevator B, which leads to the third level of Phazon Mines.



Use a Power Bomb to destroy the rubble blocking the Phazon Mining Tunnel, then enter the hole in the wall. Be sure to use your Boost Ball to pass through the tunnel safely. If you don't, the floor will collapse and you'll be dropped onto the Phazon below.



The next hallway is filled with invisible Scatter Bombus. Use your X-ray Visor to target them, then hop across the Phazon floor to Metroid Quarantine B.

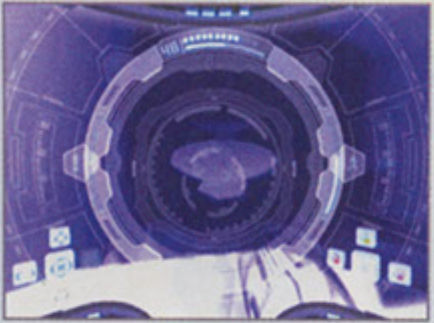

It looks like a dead end. Hop onto the mushrooms and use your X-ray Visor. You see two invisible platforms floating over the pit. Use them to cross.



Continue on to Fungal Hall A. Notice that there's a lot of Phazon on the ground as you get deeper into the cave. Avoid falling into it, and get out fast if you should happen miss a jump.



The next room is similar in design to Fungal Hall A. Eliminate the Metroids, then cross the mushrooms to the back of the room. Drop down to the floor and inspect the area below the door. There's a circle of small mushrooms on the ground. Use a Power Bomb to destroy the circle and reveal a Missile Expansion.



Defeat the Troopers in Metroid Quarantine B, then use the magnetic rail to reach the platform above. From there you can use your Grapple Beam to swing across the pit.



Jump up the ledges on the right and use your X-ray Visor again to spot another invisible platform, which you can use to reach the landing where the magnetic rail begins.



Use your Ice Beam to eliminate the Hunter Metroids in the area, then hop from mushroom to mushroom to cross the room.



Climb back up to where you can reach the Glider. On the left is a Missile Station and on the right is the path to the Elite Quarters. Use your Grapple Beam to attach to the Glider and swing to either side. If you need missiles, be sure to fill up first.



Use a Power Bomb to destroy the wall to the left of the magnetic rail, then the next wall that blocks your path. You'll be able to access a second magnetic rail that stretches across the pit you crossed earlier. Use the X-ray Visor to look for another invisible platform on the opposite side. Ride the platform up to find a Missile Expansion.



Near the back of the room is a Glider flying around. Attach your Grapple Beam to the Glider and swing to the large mushroom near the next door. Remember to shoot your Grapple Beam as the Glider begins to turn toward the door.

Plasma Trooper

[[LOG BOOK]]

Surprisingly, Plasma Troopers & Space Pirates armed with Plasma Beam technology.

Space Pirates have revealed, amongst several of your weapons, including the Plasma Beam. It has a fire strength that makes these Troopers vulnerable to

The Plasma Trooper is the last of the Troopers you'll encounter. It uses a modified Plasma Beam and can be identified by the red lines across its armor. Use your Plasma Beam to defeat them; no other weapon will work. The Plasma Beam has a very high rate of fire, so you don't even need to charge your shots. Just fire like crazy, and they'll fall quickly.

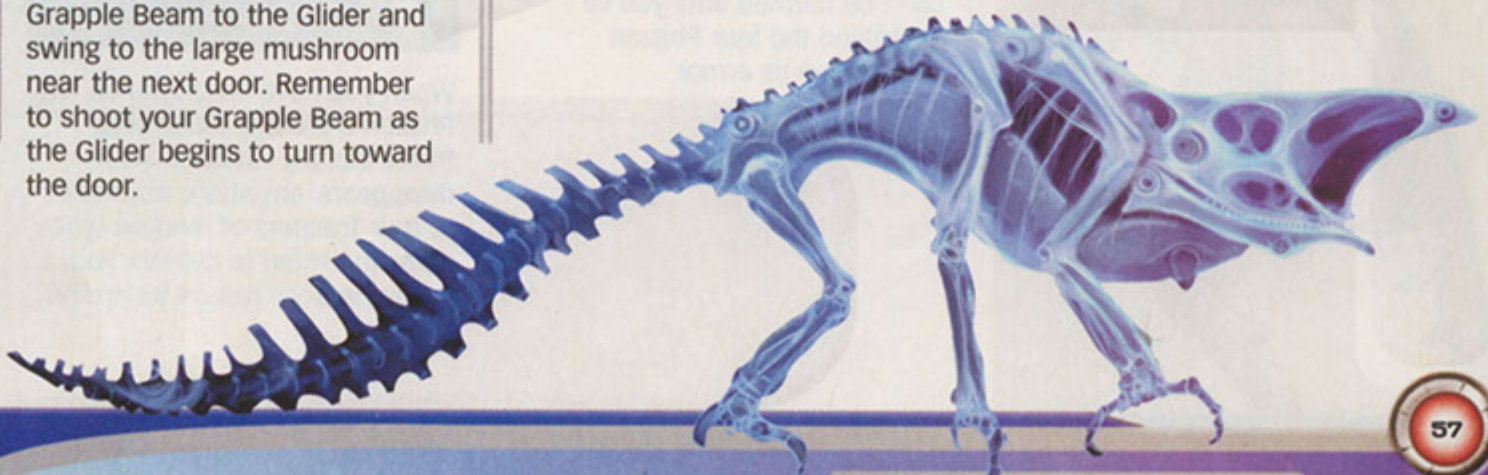



A force field blocks your progress. Check the computer console to the side to bring the field down, then head into the room beyond. Be sure to check the computers for Pirate Data.



Near the computer consoles is a solid pillar made of Cordite. Blast it with a Super Missile to find a Missile Expansion.



Be sure to visit Save Station Mines C, then head upstairs and through the Plasma Beam door. The hall leading to the Elite Quarters is barred shut. Shoot the ice over the door with your Plasma Beam, and the locking mechanism disengages.

BOSS BATTLE: OMEGA PIRATE



As you enter the Elite Quarters, you see the most fearsome sight yet: a gigantic Elite Pirate known as the Omega Pirate. This beast is at least two or three times larger than anything you've fought so far.



The Omega Pirate attacks just like any Elite Pirate. It slams its fists into the ground to create an electric shock wave. You can double jump over the waves to avoid them. It also has cannons on its back, which it will use only if you're on the opposite side of the room.



What makes the Omega Pirate unique is its phenomenal defensive powers. It can absorb beam weapon attacks when it holds out its left hand. But it also can't be harmed until you've destroyed the four Phazon deposits on its armor.



Use your Plasma Beam and carefully dodge the wave attacks while blasting the Phazon deposits. Stay close to the Omega Pirate, but just out of striking distance. If you get too close, the Omega Pirate will begin swiping at you with its enormous fists.



Quickly destroy one or two Troopers by using the appropriate beam weapon. In cases where there are four Troopers, destroy whichever Troopers can be eliminated most easily (normally, Ice Troopers or Plasma Troopers). Use your combo weapons. Speed is extremely important here, so hold nothing back.



When you have destroyed all four Phazon Deposits, the Omega Pirate literally vanishes. As it disappears, anywhere from two to four Troopers of random types enter the room to distract you while the boss repairs its armor.





After fighting for a few seconds, switch to your X-ray Visor and scan the room for the Omega Pirate. It will be over one of the Phazon patches on the floor. While the Omega Pirate repairs its armor, you can shoot its core to cause actual physical damage. *This is the only time you can hurt the Omega Pirate.* Be sure to use the Plasma Beam; it has the highest rate of fire, and you shouldn't need to charge your shots to cause significant damage.



If you're really fast, you'll cause the Omega Pirate to collapse while it repairs. It will then disappear again. Quickly focus on any Troopers that remain in the room, then search for the Omega Pirate again. It will have moved to a different Phazon Patch. Retarget the boss and let it have it. If you seriously injure the Omega Pirate a second time, it'll disappear and more Troopers will enter the room.



The real trick to this battle is to avoid being caught up in fights with the Troopers. Their only purpose is to distract you long enough for the boss to repair itself, and they're very good at it. Eliminate as many as you can in about 10 seconds, then search the room for the boss. If you don't see it, quickly pick on the Troopers for a couple more seconds, then look for the boss again. Once you see the boss, ignore the Troopers completely and just focus on causing damage to the Omega Pirate while you can.



Continue repeating the process of destroying the Phazon deposits, blasting the Troopers, and damaging the boss until the Omega Pirate is history. Upon victory, Samus receives the Phazon Suit. She can now pass through Phazon without taking damage, and her shielding is slightly stronger than before, so she'll take less damage from attacks.

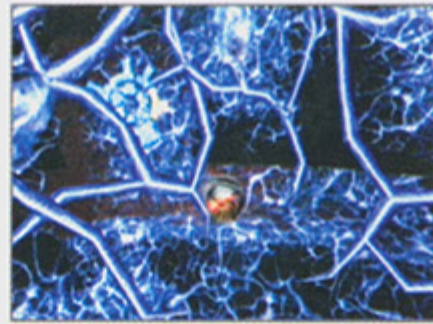

Return to Save Station Mines C and save your game, then head back to the Phazon Mining Tunnel. Look for a passage covered in Phazon behind a small rock. Destroy the rock with a Morph Ball Bomb and head into the tunnel. It's a long, long run to the bottom, and you must destroy multiple rocks. When you reach the bottom, you find the Artifact of Newborn. You now should have all 12 Chozo Artifacts.



Return to the Elite Quarters. Use the lift on the side to reach the catwalks above. Pass through the door at the end into the Processing Center Access tunnel, where you find the last of the Energy Tank upgrades.



Continue into the Phazon Processing Center. This tall room is your way out. Pick off the various Troopers as best as you can from the bottom of the room; there are several around, along with a Mega Turret, so be careful.



Hop up the floating platforms in the center of the room. When you reach the last one, use your X-ray Visor to spy a couple hidden platforms that lead higher. When you get to the top, look around with the X-ray Visor to spot a Missile Expansion tucked in a small alcove along the wall. Jump over to the ledge and use a Power Bomb to uncover the Missile Expansion. This is the last of the upgrades.



You should now be as strong as you're ever going to be. You should have 14 Energy Tanks, 250 missiles, 8 Power Bombs, and every major upgrade to your weapons, visor, Morph Ball, and Power Suit. Continue to the top of the Phazon Processing Center and head to Elevator A to make a quick trip to the Transport to Tallon Overworld South.



Meta Ridley and the Impact Crater

RETURNING THE ARTIFACTS



It's been a long and hard road, but you're finally ready to challenge the Impact Crater, which is located below the Artifact Temple in Tallon Overworld. Head that way and be sure to pay a visit to Samus's ship to save and reload.

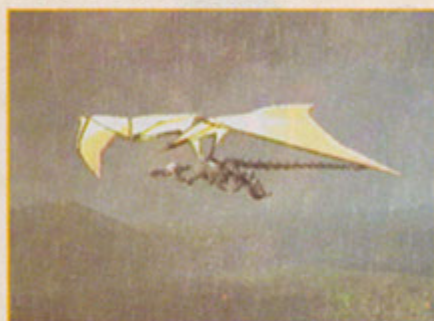

When you arrive at the Artifact Temple, you witness the unlocking of the Impact Crater. Unfortunately, the light show also attracts Meta Ridley, who you've been chasing since the very beginning of the game.

BOSS BATTLE: META RIDLEY



Meta Ridley is a huge pterodactyl-type creature that can fly and uses powerful energy weapons along with old-fashioned brute force. It has one weak spot in the center of its chest, which isn't always visible. You must use your Plasma Beam to defeat this boss.



The fight begins with Meta Ridley in the air above you. It attacks in several ways. At times Meta Ridley hovers over the side of the Artifact Temple and shoots its laser and missiles at you. You can double jump the laser and outrun the missiles by strafing back and forth. While Meta Ridley hovers, its chest is exposed, so this is also your best chance to cause damage. Lock on and rip it to shreds.



Meta Ridley occasionally flies off into the distance. You can't hurt it when it does this, so just prepare to dodge. As Meta Ridley flies back toward the temple, it shoots a beam and drops a spread of bombs. Use your Morph Ball and Boost Ball to dodge these attacks by zooming from one side of the arena to another.



Sometimes Meta Ridley will even land in the center of the temple to take a swipe at you with its claws. Watch for its shadow to settle in the center as a sign it's about to land. Quickly strafe to the side or double jump backward to avoid the attack.



Continue pounding the Plasma Beam on Meta Ridley's weak spot. Eventually, the heat will cause Meta Ridley's wings to combust and the golden membrane to burn away. Without its wings, it can no longer fly, and the battle moves to the ground.



The battle heats up a bit now. Meta Ridley attacks by charging back and forth across the temple floor. You can tell when it's about to attack because it will rear back before dashing. Dodge the attack by strafing to either side.



After dashing, Meta Ridley will either dash again or look over its shoulder. Should the boss peer over its shoulder, it's preparing to swipe at you with its tail. Double jump over the boss's tail, or move backward to get out of the way.



While all of this is going on, you're probably beginning to wonder when you can attack. Meta Ridley sometimes shoots a laser from its mouth. You can jump the laser, but more importantly, a roar usually follows this. While Meta Ridley has its mouth open, you can shoot it in the head. This doesn't cause damage to the boss, but if you hit it in the head enough, you stun it and the boss's weak spot, the chest, is exposed.



Just continue dodging attacks and waiting for your chance to counterattack. This part of the battle can take a long time, so have patience. When you have defeated Meta Ridley, the transport into the Impact Crater will appear.



IMPACT CRATER: THE FINAL SHOWDOWN

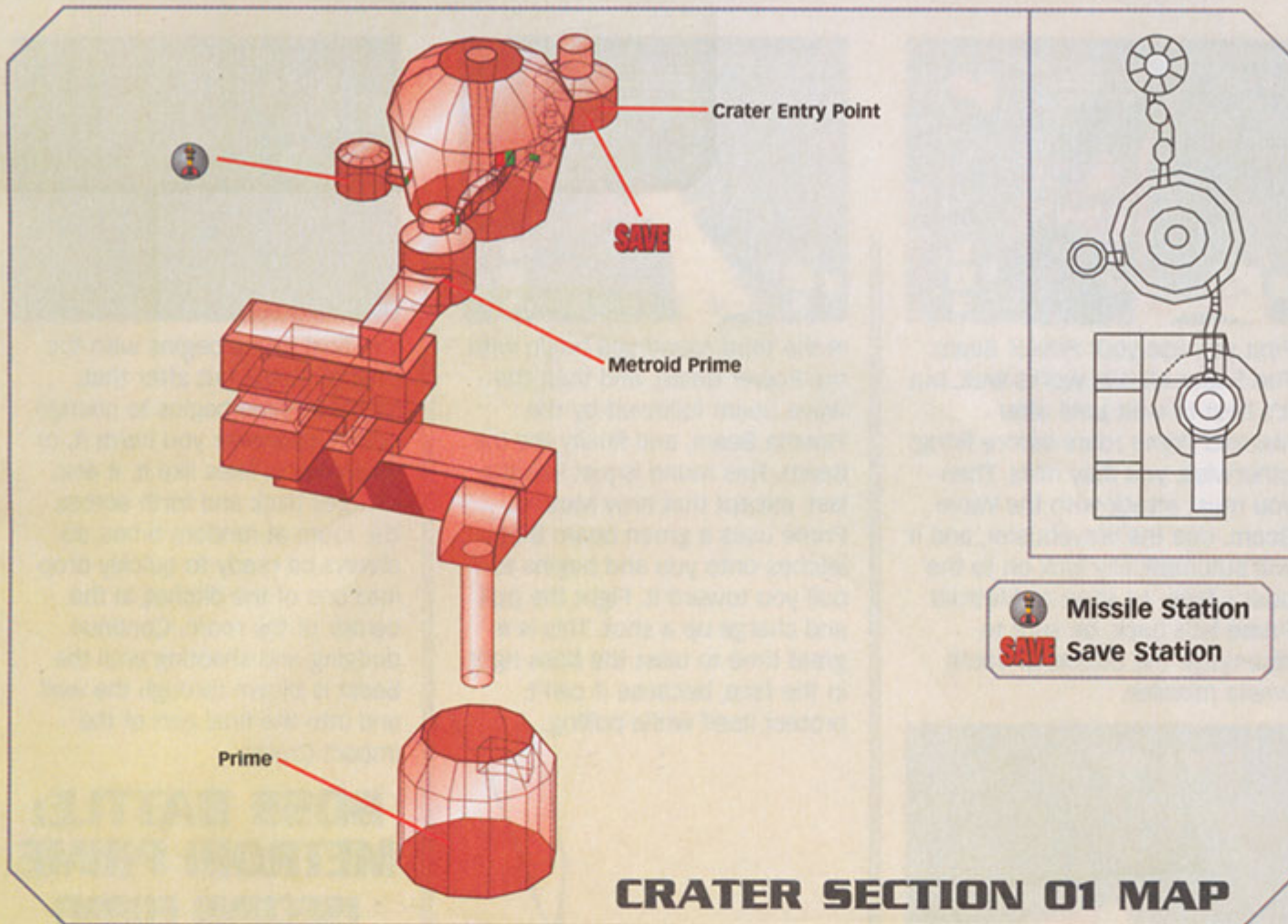

Move swiftly into the Missile Station and take a breather. More Fission Metroids are hot on your tail, but now it seems there's an endless supply of the little energy suckers.



You must make a mad dash for the door at the very top. Leave the Missile Station and set off a Power Bomb or two. This will clear the immediate area of enemies. Then quickly dart up the next set of platforms to the exit. You *will* be caught along the way and you'll have to stop and use more Power Bombs to escape. There's no avoiding it.



Take the Transport down into the Impact Crater. There's a Save Station in the very first room. Be sure to use it.



Enter the next hall on your way to the Phazon Core. Blast a path through the Lumigeks and hop across the room. Beware of the red Phazon. Your suit won't protect you from this deadly energy.

Lumigeek

Lumigeeks are very similar to Tallon Crabs and Parasites. They cover halls in great shifting hordes. They aren't at all aggressive, but running into them causes you damage. Blast a path through them and quickly pass by before they can regroup.



Past the Lumigeeks, you enter the Phazon Core, a huge area with small platforms that cut back and forth across the room in a line to the top. Enter the room and look for a nearby Fission Metroid. Blast it once to lure it to you, then duck back through the door. Multiple Fission Metroids should show up. Pick off all of them before heading to the Missile Recharge Station Crater.



Use the magnetic rails in the next hallway to reach the depths of the crater where Metroid Prime awaits. Follow them out of the room and into the large hall below.



Fission Metroid

Fission Metroids have the strange ability to split in two when damaged. The resulting Fission Metroids are immune to all but one type of beam weapon. You can tell which one by the color of the enemy's body and pincers. Fission Metroids created by a slit cannot split again. All Fission Metroids are susceptible to Power Bombs. In most cases, you should just outrun these creatures, or wait for them to come near, then destroy them with a Power Bomb. Trying to fight a horde of them is impossible, because the horde just keeps growing and growing each time they split.

BOSS BATTLE: METROID PRIME



Metroid Prime's only weak spot is its face, which sits in the middle of its body. The boss has a strong carapace that deflects any attack that doesn't hit the weak spot. As Metroid Prime attacks and moves around, the face will occasionally be blocked by a part of the body, so you must choose your shots wisely.



Only one beam weapon at a time will work on the boss. Much like the Troopers you faced in Phazon, you can tell which weapon will work by the color of the lines in Metroid Prime's carapace. Yellow is Power Beam, purple is Wave Beam, white is Ice Beam, and red is Plasma Beam.



Don't toy with Metroid Prime. Use your combos to really lay into the boss and defeat it quickly. You'll go through a lot of missiles, but it will be worth it. You can't afford to lose much energy in this battle.



First you use your Power Beam. The Super Missile works well, but it's best to wait until after Metroid Prime roars before firing; otherwise, you may miss. Then you must attack with the Wave Beam. Use the Wavebuster, and it will automatically lock on to the boss's face. As soon as Metroid Prime falls back, be sure to disengage the attack, or you'll waste missiles.



Metroid Prime flees the room and Samus follows. In the second round, you use the Power Beam, then the Ice Beam, and finally the Wave Beam before the boss flees again. What's different in this round is that every time you seriously injure Metroid Prime, it charges across the room in an attempt to trample you. Look on the floor and notice three large grooves. Whenever you knock the boss backward, quickly enter Morph Ball mode and roll into one of these grooves. Metroid Prime will pass over harmlessly.



In the third round you begin with the Power Beam, and then the Wave Beam followed by the Plasma Beam, and finally the Ice Beam. This round is just like the last, except that now Metroid Prime uses a green beam that latches onto you and begins to pull you toward it. Fight the pull and charge up a shot. This is a great time to blast the boss right in the face, because it can't protect itself while pulling.



The final round begins with the Charge Beam, but after that, Metroid Prime begins to change colors whenever you harm it, or whenever it feels like it. It also charges back and forth across the room at random times, so always be ready to quickly drop into one of the ditches in the center of the room. Continue dodging and shooting until the beast is blown through the wall and into the final part of the Impact Crater.

BOSS BATTLE: METROID PRIME (SECOND FORM)



Metroid Prime's carapace may be destroyed, but the inner creature is still alive and well. The battle is about to get extremely tough.



Prime attacks in two ways; it can ram into you, and it can shoot red Phazon waves, which you can jump over. The waves move quickly, so you must react very quickly.

TIP

Charged shots that bounce off of the carapace often come right back at you in the form of a round ball. Blast these balls to destroy them, and they often drop power-ups. The easiest ones to destroy are from the Plasma Beam. Note that all shots that bounce off the carapace can damage you.





Neither of these attacks is particularly devastating on its own, but Prime has more tricks up its sleeves. Prime can also create Metroids (Metroids, Hunter Metroids, and Fission Metroids) to assist it in battle. The Metroids are always created in pairs, and each time, a pool of Phazon energy is left behind.



Prime can also shift its physical appearance, sometimes disappearing so it can only be seen by using the Thermal Visor or X-ray Visor. Which visor is needed is random. Just look around with each and hope you can see it.



To make matters worse, only one weapon can damage Prime: the Phazon Beam. What's a Phazon Beam? Your Phazon Suit not only protects you from Phazon energy, but it also allows you to siphon energy from Phazon pools into a devastating continuous beam. Each time Prime creates Metroids, it leaves one of these pools behind. Stand in a pool, and your gun will undergo a transformation. Pressing **A** causes it to shoot a Phazon blast, but this will also drain the Phazon pool. Once the pool is empty, you must find another one.

TIP
Try to stay in the middle of Phazon pools. As you use them, they shrink smaller and smaller until completely exhausted. If you stand right in the center, you can use the entire pool without pausing. If you're not, you must realign yourself as the pool shrinks.



The battle plan is simple. Dodge Prime's attacks until it creates Metroids and drops a pool of Phazon. Quickly enter Morph Ball mode and roll below the Metroids to the pool. Use the Phazon Beam quickly to destroy the Metroids, then find Prime by using your Thermal or X-ray Visor. As you look around, you must be ready to jump Prime's wave attack. If it hits you, you'll be knocked across the room and have to fight your way back to the Phazon.



Any time you draw a bead on Prime with your Phazon Beam, just hold the button down and don't let up until you're out of energy. It won't take long to conquer Prime.

TIP

Should a Metroid latch onto you, use a Power Bomb to dislodge it. The explosion should take out the Metroid and any others immediately around you.



With Prime destroyed, Samus can rest easily. You've done well, but how well? There are three endings to the game. Which one you see depends on how full your Log Book is and how many of the major and minor upgrades you found along the way. Look in the "Secrets" section for a breakdown on what it takes to get all three endings.



Enemies

DANGERS ON TALLON IV

As you explore Tallon IV, you encounter many unfriendly creatures of all sorts of different shapes, sizes, and powers. Knowing what you're up against is often the only thing that will save you from defeat. In this section we try to give you a heads-up on what's to come.

Notice two key bits of information for each enemy: **Found In** and **Recommended Weapon**. The **Found In** refers to what part of Tallon IV is habitat for that creature. Use this when you're looking for a particular creature, especially when you're trying to round out your Log Book data. The **Recommended Weapon** is a suggestion as to which weapon you should use when facing the creature. In most cases, this may not be the only weapon that works. You may even prefer a different weapon than what we suggest, but we guarantee that the suggested weapon will be effective. If nothing else, it could save you from wasting ammunition, or better yet, help you out of a jam.

For the bosses, we've added information on weak spots. Bosses are very powerful creatures and should be defeated by exploiting their weak spots. A weak spot is a place on the boss that is most vulnerable to your attacks. Always aim for the weak spot; the faster you beat the boss, the greater your chances for survival.

Aqua Drone



Found In:
Tallon Overworld

Recommended Weapon:
Wave Beam

Aqua Drones float around in the waters of Tallon Overworld scanning the area for intruders. When an enemy is encountered, they lock any nearby exits to prevent escape. The

doors remain locked until the Aqua Drone or its captive is eliminated. The Space Pirates weren't able to shield these machines against electrical attacks. Fire your Wave Beam at them to destroy them.

Aqua Pirate



Found In:
Tallon Overworld

Recommended Weapon:
Missile Launcher

The aquatic version of the Space Pirate is just as dangerous as its relatives. Very similar to the Flying Pirates you'll encounter in other areas, it's just as maneuverable.

Aqua Pirates are best destroyed with a couple missiles, or an Ice Beam attack followed by a missile. If you really want to take them out fast, try Super Missiles.

Aqua Reaper



Found In:
Tallon Overworld, Phendrana Drifts

Recommended Weapon:
Any (effects are temporary)

Related to the Reaper Vine, they are found in the watery depths of Tallon Overworld. Like the Reaper Vines, Aqua Reapers can only be spooked back into their holes for a limited

time. Shoot the Aqua Reaper near its blade-like claw with any weapon to send it flailing back into its hole. There is no known way to destroy them completely. If you are not gone by the time the Aqua Reaper emerges from its hole again, it will slap you around and inflict a good amount of damage.

Aqua Sac

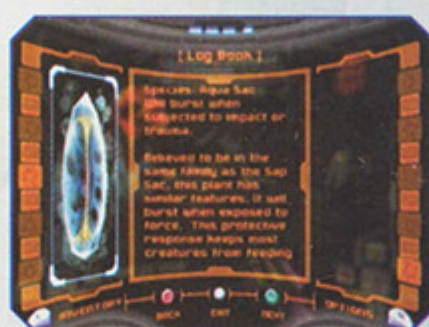

Found In:
Tallon Overworld

Recommended Weapon:
Any

Found underwater, this relative of the Sap Sac is a highly explosive creature. When agitated, it explodes violently and damages any nearby creatures. Blow up an Aqua Sac with

any weapon to aid in the destruction of nearby creatures. Don't stand too close, though, or you'll take a large amount of damage.

Auto Turret



Found In:
Magmoor Caverns, Tallon Overworld, Phendrana Drifts

Recommended Weapon:
Missile, Ice Beam

Auto Turrets, also called Auto Defense Turrets, are powerful and quick to detect movement in their assigned areas. Use any nearby

obstacles for cover and peep out to shoot a couple missiles at them. If you have the Ice Beam when you encounter Auto Turrets, you can freeze them with a single blast and finish them off without worry of taking damage. The ice does melt off eventually, so destroy them quickly after freezing them. Also be on the lookout for any nearby switches; Sometimes you can disable turrets simply by scanning a switch.

Baby Sheegoth

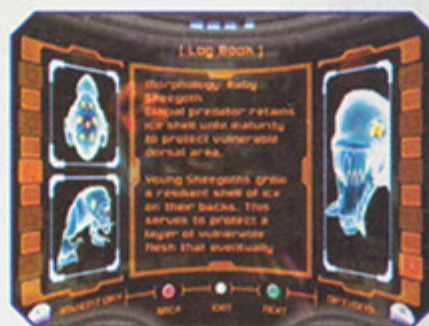

Found In:
Phendrana Drifts

Recommended Weapon:
Missile Launcher, Plasma Beam

Baby Sheegoths have hard ice shells on their backs that protect the soft flesh underneath. To destroy a Baby Sheegoth, you must destroy the ice shield from behind. Once the soft

fleshy part is revealed, a few hits from your Power Beam is sufficient to put it out of its misery. To get into position, you must dash around to their backs. Their attack consists of bursts of ultracold gas and a charging attack, both of which can be avoided by dashing to the side.

Barbed War Wasp



Found In:
Chozo Ruins

Recommended Weapon:
Power Beam

These appear only in the boss battle with the Incinerator Drone. Their Barbed War Wasp hive sits directly above the Incinerator Drone. These creatures become upset when the searing heat from the malfunctioning Drone reaches their home. Barbed War Wasps can shoot their barbed stingers a great distance and regrow them in seconds. It's best to destroy them as they exit their hive. The Power Beam is the most effective weapon here because of its speed. You should also try to manually target these enemies so you can quickly switch to the next available target after eliminating the first.

Barbed War Wasps can shoot their barbed stingers a great distance and regrow them in seconds. It's best to destroy them as they exit their hive. The Power Beam is the most effective weapon here because of its speed. You should also try to manually target these enemies so you can quickly switch to the next available target after eliminating the first.

Beetle



Found In:
Tallon Overworld, Chozo Ruins

Recommended Weapon:
Any

Beetles live underground and pop out of the ground as you approach them. Quickly destroy them with any weapon you have. The Power Beam's speed helps when fighting more than

one Beetle. Be ready to dash out of the way of their charge attack. Beetles are unwilling to travel very far when pursuing an enemy. If you back up quickly, you'll find that they dig back into the ground after a few steps. They then reappear where they first entered the scene.

Blastcap



Found In:
Tallon Overworld, Chozo Ruins

Recommended Weapon:
Any

These poisonous mushroom-like plants are strewn about Tallon Overworld and Chozo Ruins. They explode and release a noxious gas on contact. Shoot them from a distance

to be safe. If you can't help but touch one, move away quickly, and you may still be able to avoid taking damage. It's always best to manually target Blastcaps. Because they grow in groups, it's really easy to miss one in a hail of automated fire.

Bloodflower



Found In:
Tallon Overworld

Recommended Weapon:
Plasma Beam

Bloodflowers are stationary, but they eject poisonous spores if you wander within their reach. The spores are lethal to you and it. To destroy this dangerous plant, keep your distance

and wait for it to propel the green ball of spores at you. Once the ball is in the air, shoot the ball to send the spores back to the Bloodflower. The resulting explosion should be enough to wipe out the vicious plant. The Plasma Beam is extremely effective against this enemy. Although the Ice Beam can be used, it won't eliminate the enemy; you'll have to follow up the cold attack with a missile to finish the job.

Burrower

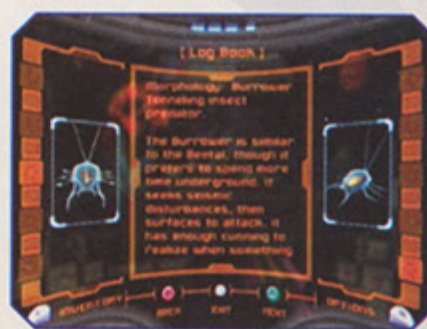

Found In:
Magmoor Caverns, Phazon Mines

Recommended Weapon:
Power Beam, Morph Ball Bomb

Burrowers do just that: burrow. You can tell where they are by the moving raised mound of dirt on the ground. While underground, they are impervious to all of your attacks. You

must either shoot them while they are in the air or lay a Morph Ball Bomb directly over them and hope that it explodes as they submerge. Be sure to use a weapon with a high rate of fire. You don't get much time to blast them when they pop out of the ground.

Chozo Ghost



Found In: Chozo Ruins

Recommended Weapon:
Power Beam

Chozo Ghosts are spectral entities that phase in and out of existence. The only reliable way to track them is with your X-ray Visor. They are invulnerable to most beam weapons, and their erratic nature causes

missiles to fly aimlessly. The only way to defeat them is to hit them with your Power Beam. Use charged shots, and constantly dodge to the sides to avoid their attacks. If they hit you, their spectral energy will temporarily interfere with your visor and weapons system. Once you have the X-ray Visor, they're extremely easy to defeat even in large groups.

Crystallite

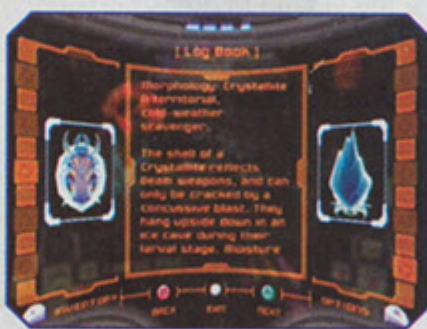

Found In:
Phendrana Drifts

Recommended Weapon:
Missile Launcher

Crystallites crawl around on the frozen surfaces of Phendrana Drifts. Their hardened ice carapace makes them invulnerable to everything but

missiles. Crystallites travel in a set feeding pattern and should be destroyed before you attempt to travel over their territory. Though they aren't aggressive, they will cause you damage if you run into them.

Elite Pirate



Found In: Phazon Mines

Recommended Weapon:
Power Beam, Charge Beam

Elite Pirates are well armored and well armed. Watch for them to pound on the ground, sending a wave of energy toward you. Double jump over this wave and fire your Power Beam or missiles at it. When it is not

pounding the ground, the Elite Pirate holds up its hand and absorbs any beam weapon you fire at it. Avoid firing at it during this time and just charge your next shot. With just a little bit of practice, you'll be able to eliminate these creeps without much of a battle.

Eyons



Found In: Chozo Ruins

Recommended Weapon: Charge Beam

Eyons are mounted on the walls of Chozo Ruins. Their sustained energy beams wave around in random patterns and are lethal. The bright flash from any of your weapons is enough to shut them down for a short time. To destroy Eyons, you must use the Charge Beam.

Fission Metroid



Found In: Impact Crater

Recommended Weapon: Any beam weapons, Power Bomb

Fission Metroids are aggressive and have the ability to split into two identical Fission Metroids after taking sufficient damage. The two resulting Fission Metroids are invulnerable to most weapons except for one, which

is randomly determined. The only way to tell is to look at their color. Fission Metroids with yellow tips and body are vulnerable only to Power Beam attacks; purple tips and body, Wave Beam; white tips and body, Ice Beam; red tips and body, Plasma Beam.

Before they split up, you can destroy the Fission Metroid without the splitting effect by letting them attach to you. Once one is attached, turn into the Morph Ball and lay a Power Bomb. The Power Bomb is powerful enough to completely pulverize the Fission Metroid.

Flaahgra



Found In: Chozo Ruins

Recommended Weapon: Missile Launcher and Charge Beam stuns only

Weak Spot: Mirror reflectors

Flaahgra is the huge flower that has been making all the water around Chozo Ruins toxic. Your weapons can only stun it for a short time. While stunned, you must knock down the sunlight reflectors that it gets energy from. Hold **[R]** to keep Flaahgra targeted. Shoot missiles or your Charge Beam to stun it while you strafe toward the mirror reflectors. You must shoot the red orb at the bottom of the reflectors to knock them over.

Without sunlight, the Flaahgra keels over and gives you time to inflict the real damage at the base of it while in Morph Ball mode. Flaahgra is very protective of its mirrors. If you shoot them, it tries to reposition the mirrors. The only way to prevent this is to keep pummeling Flaahgra so that it remains stunned.

Flaahgra Tentacle

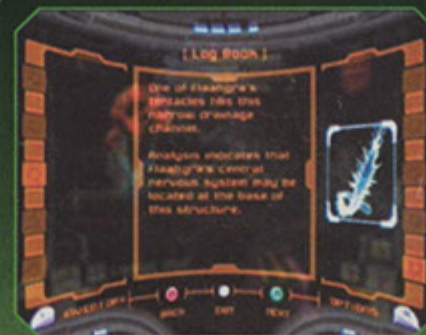

Found In: Chozo Ruins

Recommended Weapon: Morph Ball Bomb

Weak Spot: Base of Flaahgra

The Flaahgra Tentacle has sharp thorns that can cause damage to anyone foolish enough to come too close. Once retracted, you can lay a Morph Ball Bomb in its Morph Ball slot at the bottom of Flaahgra's base. To get the Flaahgra Tentacle to retract, you must shoot down the reflectors surrounding Flaahgra. Once all the reflectors are out of commission, the Flaahgra Tentacle retracts and Samus can enter Morph Ball mode to roll into the tunnel and lay a bomb.

Flickerbat



Found In: Phendrana Drifts

Recommended Weapon: Any

Flickerbats fly in circular patterns in Phendrana Drifts. Their optical camouflage renders them nearly invisible to the naked eye. You can't easily target Flickerbats until you find

the X-ray Visor. They don't bother you unless you stand in their feeding pattern. The best way to get them out of your way is to manually target them with **[R]** and shoot your quick-firing Power Beam.

Flying Pirate



Found In: Phendrana Drifts, Magmoor Caverns, Tallon Overworld

Recommended Weapon: Missile Launcher, Ice Beam, Plasma Beam

Flying Pirates are the airborne versions of the Space Pirates. They fly around with their thermal jetpacks and shoot missiles at their targets. Space Pirates are one of the most dangerous common enemies in the game. Their missiles inflict a lot of damage and are hard to avoid. The Plasma Beam is most effective against them. If you don't have the Plasma Beam yet, freeze them with your Ice Beam and blow them up with missiles. No Ice Beam either? You'll just have to destroy them the old-fashioned way: missiles. But be careful if you are only using missiles; after you destroy them, they come crashing down on you in a violent explosion. Dash out of the way if you see them headed toward you.



Geemer



Found In: Tallon Overworld

Recommended Weapon: Missile Launcher

Geemers crawl around on the slick rocks of Tallon Overworld. They are invulnerable to every weapon except for the Missile Launcher. Their spikes can cause some damage, but they stick to their set hunting patterns and you can usually just jump over them.

Glider



Found In: Phendrana Drifts, Tallon Overworld, Phazon Mines

Recommended Weapon: Grapple Beam

Gliders are harmless creatures that soar high above the ground. They have an unusual magnetic signature that allows you attach the Grapple

Beam to their underbellies. Thus they can be used to swing from place to place. This can be tricky, because Gliders are always on the move. Always shoot your Grapple Beam before the Glider has moved into the position where you want it to be. It will take a moment for the beam to attach and tighten, and the Glider won't stop moving until you begin to swing.

Grizby

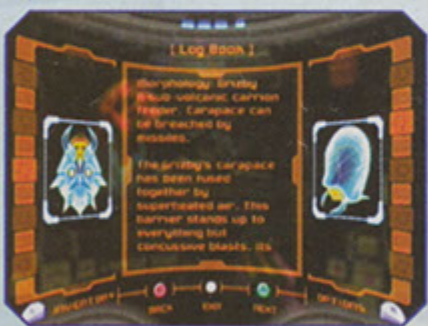

Found In: Magmoor Caverns

Recommended Weapon: Missile Launcher

Grizbies are found exclusively in the harsh environment of Magmoor Caverns. The intense heat of their home has fused their carapace into a barrier that is invulnerable to all but

the concussive effects of the Missile Launcher. Grizbies aren't aggressive and stick to their set scavenging patterns. The damage they cause isn't much, but they can push you off platforms into the more lethal lava. A single missile fired from a distance is enough to rid you of these creatures.

Hive



Found In: Chozo Ruins

Recommended Weapon: Missile Launcher

War Wasp Hives are the home of War Wasps. Find them high on the walls of Chozo Ruins. If you do not destroy the hives, War Wasps continue to emerge from them. It's best to

identify War Wasp Hives as you enter each area and shoot each of them with a missile. Once they are destroyed, you are free from the nuisance of War Wasps for the duration of your stay in that area. However, War Wasp Hives are rebuilt once you leave the area for any length of time.

Hive Mecha



Found In: Chozo Ruins

Recommended Weapon: Power Beam

Weak Spot: Four entrances marked by red light

The Hive Mecha's only defenses are the Ram War Wasps. Once deployed, the Ram War Wasps

circle around you and try to push you into the toxic waters. After each round of Ram War Wasps is defeated, target the red light from one of the entrances to the Hive Mecha. You must repeat this process until the Hive Mecha blows up. See Ram War Wasp also.

Hunter Metroid



Found In: Phendrana Drifts, Phazon Mines, Impact Crater

Recommended Weapon: Ice Beam

The young adult version of the Metroid parasite, Hunter Metroids are better adapted at hunting prey. They extend a tentacle that inflicts

damage to their potential meal. They're also known for ramming into enemies, which can be just as deadly. The best weapon to use against Hunter Metroids is the Ice Beam. If you are caught by a Hunter Metroid's tentacle, you must shoot it off of you. Freeze the enemy, then finish it off with a missile.

Ice Beetle



Found In: Phendrana Drifts

Recommended Weapon: Plasma Beam

The Ice Beetle is a better-armored version of the standard Beetle. The ice covering its body makes Ice Beetles a little resistant, but not immune, to all attacks but the

Plasma Beam. If you don't yet have the Plasma Beam when you face them, any weapon will do; just be prepared to shoot them with a few extra shots.

Ice Burrower



Found In: Phendrana Drifts

Recommended Weapon: Power Beam, Morph Ball Bomb

Ice Burrowers burrow in the frozen grounds of Phendrana Drifts. You can spot them by the raised trail they leave behind. To destroy them with your quick-firing Power Beam, you

must wait until they sense your presence and pop out of the ground. To destroy them while they are still burrowing, turn into the Morph Ball and lay a bomb on top of them. The Morph Ball Bomb you lay will also destroy them if they pop up above ground before it detonates.

Ice Parasite

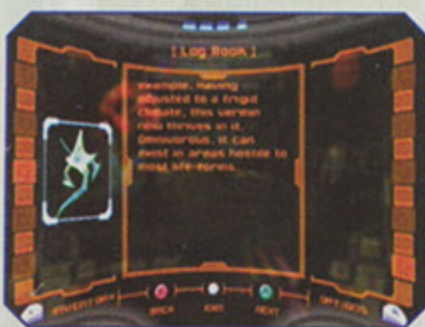

Found In:
Phendrana Drifts

Recommended Weapon:
Power Beam

Ice Parasites have adapted to the frigid environment of Phendrana Drifts. As with the rest of the Parasite family, shoot them quickly with your Power Beam before they can reach you. If you are in Morph Ball mode, you can roll right by them without taking much damage before they settle on the floor.

Ice Shriekbat



Found In:
Phendrana Drifts

Recommended Weapon:
Power Beam

Ice Shriekbats are the frosty versions of Shriekbats. Found only in Phendrana Drifts, treat them like you would Shriekbats. Destroy them quickly or simply step out of the way once they are in the air. To enter them into your Log Book, you must scan them the first chance you get; after you fight Thardus, they will not reappear.

Ice Trooper



Found In:
Phazon Mines

Recommended Weapon:
Ice Beam

Ice Troopers have reverse-engineered the Chozo technology to employ your Ice Beam into their weaponry. Though not as powerful as the original designs, they still pack quite a punch. The flaw in their design makes them vulnerable to Ice Beam attacks. It's always best to use a charged shot from your Ice Beam to freeze them, and then finish them off with a missile. Normal shots are just too slow and take far too long to do the job.

Jelzap

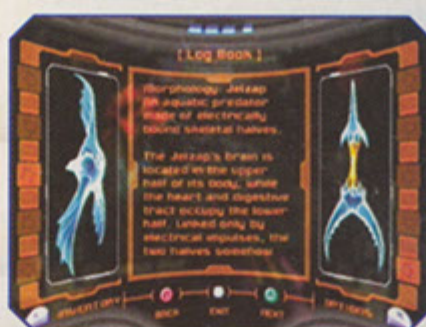

Found In:
Tallon Overworld, Phendrana Drifts

Recommended Weapon:
Any

Jelzaps are water dwellers and are vulnerable only at close range when the top and bottom halves of their body separate to launch an attack. When you approach a Jelzap, it separates at the middle and charges up for the attack. The charge-up has a sucking effect and will pull you toward it. Jelzaps are only vulnerable when they are charging up for the attack. Missiles are most effective, but Jelzaps can be blown up with any of your weapons. It's also easy to dodge, rather than fight, most Jelzaps.

Lumigek



Found In:
Impact Crater

Recommended Weapon:
Any beam weapon

Lumigeks are very similar to Parasites. They crawl around in large packs covering floors, walls, and ceilings. They aren't as aggressive as Parasites, but they can still cause a great deal of harm to you. Blast a path through them with your weapons, then race past before they can recover. There's no way to completely stop the flow of Lumigeks.

Magmoor



Found In:
Magmoor Caverns

Recommended Weapon:
Ice Beam, Charge Beam, Missile

Magmoors are lava-dwelling serpents with fiery breath. The flame that shoots out of their mouths has a limited range and can easily be avoided. Keep out of range of their fire-breath and throw a few missiles and Power Beam attacks to send them back to their molten depths. Use the Ice Beam to freeze the creature's head, and they're even easier to dispatch.

Incinerator Drone



Found In:
Chozo Ruins

Recommended Weapon:
Any

Weak Spot:
Red orb of internal power core

The Incinerator Drone has two "arms" that rotate at a slow rate and shoot flames. Dodge the flames and wait for the internal power core to pop up. Fire all you have at the red orb at the top of the core. When it malfunctions, the Incinerator Drone shoots flame directly up to stir up the Barbed War Wasps in the hive. You must keep an eye on the Incinerator Drone while you blast away at the Barbed War Wasps coming out of the hive. When the Incinerator Drone starts up again, it begins to rotate with one side shooting a low-to-the-ground flame and the other a high flame. Continue to stand in one spot while you shoot the Barbed War Wasps. The high flame will pass over your head if you are standing far enough away and you can jump over the low flame when it comes around. While dodging the flames and shooting the War Wasps, you must also watch for the power core to pop up. Repeat this until the Incinerator Drone is kaput. See Barbed War Wasp also.

Mega Turret



Found In:
Phazon Mines

Recommended Weapon:
Missile Launcher, Wave Beam

Mega Turrets are souped-up versions of Auto Turrets. Their shielding is better, and they have increased firepower. Destroy these from a distance with a few missiles or the

Wave Beam. The damage from Mega Turrets can be fatal; duck back and forth from behind nearby obstacles to minimize the damage you take. Also be on the lookout for any nearby switches; you can often disable Mega Turrets by scanning a switch rather than engaging them in combat.

Meta Ridley

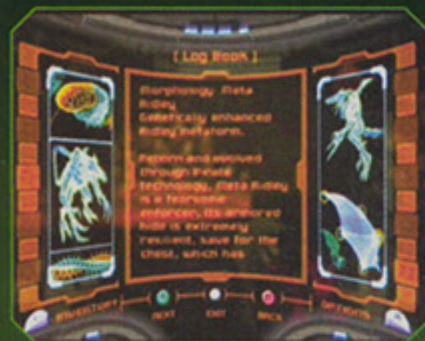

Found In:
Tallon Overworld

Recommended Weapon:
Plasma Beam

Weak Spot:
Chest and head

Meta Ridley isn't easy to catch. It has wings, which allows it to attack you from the air with its

fiery breath and bombs. While it's zooming around, you won't be able to hit it. Just go into Morph Ball mode and use the Boost Ball to dash out of the way during each pass. When Meta Ridley pauses to fire at you, it will expose its one true weak spot, its chest. Use the Plasma Beam to fry its vulnerable spot. Once you've caused significant damage, Meta Ridley's wings will ignite and burn away. This will force it to fight you on the ground.

Once Meta Ridley is on the ground, it will try to run over you. Watch it rear back. This is your signal to move. Strafe to the side to avoid being hit, but always be ready for another charge. Should the boss look over its shoulder after a charge, it's going to try to swipe you with its tail. Double jump to avoid the attack. Meta Ridley is vulnerable only when it's roaring at you and its mouth is open. Shoot the boss until you stun it, and Meta Ridley will rear back, giving you a clean shot at its chest. Though you can stun it by shooting it in the head, the chest is the only spot that will actually cause damage to the beast.

Metroid



Found In:
Phendrana Drifts, Phazon Mines, Impact Crater

Recommended Weapon:
Ice Beam, Morph Ball Bomb

Metroids are energy-based parasites that are averse to cold temperatures. A few shots from your Ice Beam are enough to destroy a Metroid. When a Metroid gets too close for comfort, it

attaches to you and won't let go. The only way to escape is to go into Morph Ball mode and lay a Morph Ball Bomb. You can destroy an entire horde of Metroids with a single Power Bomb if the situation calls for it.

Metroid Prime (First form)



Found In:
Impact Crater

Recommended Weapon:
All beam weapons

Weak Spot:
Eyes

Metroid Prime employs a wide variety of attacks. They can all be dodged easily. The only really tricky attack is its web, which hooks onto

you and allows Metroid Prime to pull you into its grasp. You can break the beam by delivering a hard shot to its face.

You fight Metroid Prime in several stages. During each stage, you must hurt it multiple times before it runs away and the next stage begins. To do so, you must pay close attention to Metroid Prime's color. Between the cracks in its armor you'll see a color that corresponds with one of your beam weapons (yellow = Power Beam, purple = Wave Beam, white = Ice Beam, red = Plasma Beam). You must use the weapon that corresponds with Metroid Prime's color in order to damage it. Target its glowing red eyes and let loose with a charged shot. If the shot strikes Metroid Prime's armor, it will bounce back toward you. Dodge, or you'll take damage. If you can afford it, use your combos to really unleash massive damage on the boss.

Each time you cause significant damage to Metroid Prime, it will fall back and let out a bloodcurdling scream. It will then either charge at you or run away. When you see it fall back, be sure to switch to Morph Ball Mode and quickly roll into one of the trenches on the floor. Thus if the boss runs toward you, it will pass over harmlessly. You can also restore your energy and ammunition by blasting the slow-moving orbs that sometimes come at you. These often drop power-ups when destroyed.

Metroid Prime (Second form)



Found In:
Impact Crater

Recommended Weapon:
Phazon Beam

Weak Spot:
Head

Prime is the end-all be-all of the game and the toughest foe you'll face. It has only one weakness, the Phazon Beam, which isn't easy to use.

Prime attacks by creating huge rings of fire and by ramming its opponent. Double jump over the fire rings and do your best to keep your distance, or you'll be chopped to bits in no time by its attacks. It can also create Metroids, Hunter Metroids, and Fission Metroids to aid it in battle.

When the boss creates Metroids, it will drop a large pool of Phazon energy on the ground. Stand in the Phazon energy, and your beam weapon will become the Phazon Beam. The Phazon Beam releases a continuous ray of energy that slices through Metroids in seconds. However, the Phazon pool will be quickly drained, and you'll need to find another supply.

To make the fight even trickier, Prime constantly alters its form, so it can't always be seen. You must use the Combat, Thermal, and X-ray Visors to track it. Which visor you use will be random, so expect to do a lot of switching. When trying to reach the Phazon pools, the Metroids released by Prime can be a real problem. Use a Power Bomb to eliminate them quickly, or get to the Phazon fast and blast them with the Phazon Beam. It's also important that you pay close attention to Prime's actions when trying to reach the Phazon and target the boss. Its attacks knock you around the room and can make standing in one spot a real problem. Dodge them, or prepare to be frustrated.

Oculus



Found In:
Chozo Ruins

Recommended Weapon:
Super Missile

These slow-moving wall crawlers don't pose much of a threat. They slowly move about and only cause damage if they run into you. Avoid them as best you can. The only time

they are really a pain is when you're trying to climb a wall where they reside. With proper timing, you'll be able to slip past them with ease.

Parasite



Found In:
Space Pirate Frigate

Recommended Weapon:
Any

Parasites travel in swarms and are found in tunnels and corridors. A few of them aren't dangerous, but a few hundred can be fatal. Shoot as many as possible from a distance. The

Power Beam is quick enough for you to destroy most of them before they reach you. Parasites are suicidal in nature. They hurl themselves at you when you draw near. In most cases it's best to just enter Morph Ball mode and run through them quickly. You shouldn't take more than a couple of points of damage in this manner.

Omega Pirate

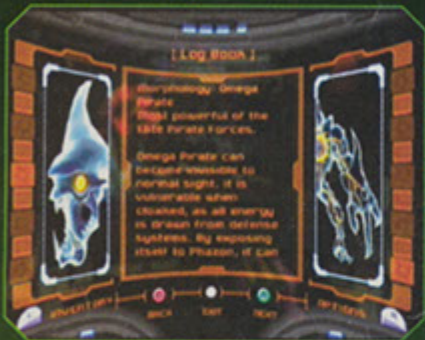

Found In:
Phazon Mines

Recommended Weapon:
Plasma Beam

Weak Spot:
Phazon deposits on armor

The Omega Pirate is immensely powerful, but not as tough as it seems. It uses several attacks,

including a shock wave and missiles, but the real threat is its cronies, which appear anytime you've eliminated the boss's Phazon supply.

You must eliminate several Phazon deposits on the creature's armor; these are what give it power. Dodge its attacks and blast away at the blue Phazon until each piece is obliterated. Once you've gotten them all, the boss will become invisible and try to repair itself.

While the boss is busy trying to make repairs, several pirates come to aid it. This ranges from two to four pirates at a time, and it will be a mixture of Power, Wave, Ice, and Plasma Troopers. Don't hold back. Eliminate them by using your combos. You don't have much time before the Omega Pirate completes repairs and rejoins the battle.

Once the Troopers are dealt with, switch to your X-ray Visor and look for the boss. It will be in one of the three Phazon pits around the room. Lock onto its chest and blast away with everything you've got. If you cause significant damage, the boss will vanish again and reappear in a different spot. Be on the lookout, and you can inflict major damage. After seriously injuring the boss twice, it will reappear automatically, and several more Troopers will join the fight.

The real trick is to avoid getting too caught up in the battle with the Troopers. They pose a serious threat, but it's best to quickly eliminate a couple of them and then to turn to the boss. If you spend all of your time fighting the Troopers, this battle can go on forever, or at least until Samus succumbs to the brutal attacks.

Parasite Queen



Found In:
Space Pirate Frigate

Recommended Weapon:
Any

Weak Spot:
Mouth

The Parasite Queen was genetically engineered by the Space Pirates to exhibit weaponlike qualities. The energy beam it shoots from its mouth is dangerous and should be avoided by a quick dash or jumping. You must scan the Parasite Queen to find the weak spot in its mouth. Without the scan, your targeting reticle only locks onto its body. Exhaust your missiles on it before resorting to the Charge Beam. The Parasite Queen is protected by a force field that can only be breached from the front. Occasionally, the field resets itself by spinning around the Queen. During this time, continue firing your Power Beam at it. The faster you shoot, the better your chances of breaching the moving gaps in the force field.

Phazon Elite



Found In:
Phazon Mines

Recommended Weapon:
Plasma Beam, Power Beam

The Phazon Elite is a more evolved version of the Elite Pirate. It attacks with shock waves in a very similar manner and has the ability to absorb beam weapons. Leap the shock

waves and blast the enemy in the face with a charged shot. When its hand is up, avoid firing. Just continue charging until you get the next clean shot.

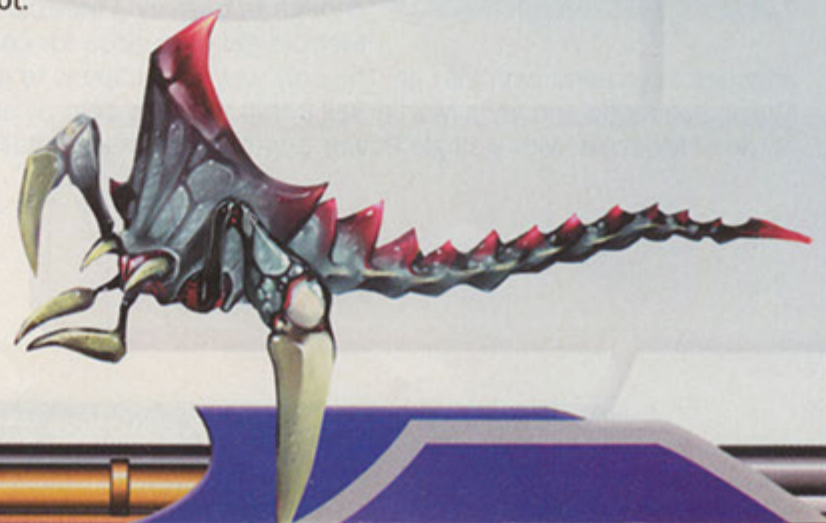

Plasma Trooper



Found In:
Phazon Mines

Recommended Weapon:
Plasma Beam

Plasma Troopers use reverse-engineered Plasma Beams. The flaw in their copy of the Chozo technology is that they are especially vulnerable to your own Plasma Beam. Keep your

distance and use the Plasma Beam to get rid of this dangerous nuisance. The Plasma Beam's rate of fire is high enough that you really don't even need to use a charged shot against the enemy, but it doesn't hurt.

Plated Beetle



Found In:
Chozo Ruins

Recommended Weapon:
Missile Launcher

Weak Spot:
Rear abdomen

The Plated Beetle is a larger and more heavily armored version of its cousin, the Beetle. The Plated

Beetle is invulnerable to all attacks from the front. Only its red rear abdomen is vulnerable to attack. Stand your ground, leaving plenty of room on either side to dash when the time comes. The Plated Beetle likes to charge at you and stop just before it reaches you. It then strafes from side to side before it goes in for the attack. Watch for the shimmering horns and dash to the side. When the Plated Beetle shoots right past you, unleash the fury of your arsenal at its brightly colored rear abdomen. Missiles work the best but can be slow. For quicker but less damaging shots, use the Power Beam.

Plated Parasite

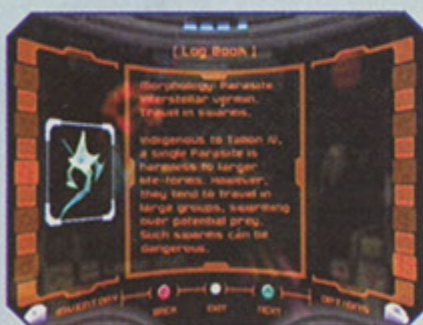

Found In:
Magmoor Caverns, Chozo Ruins

Recommended Weapon:
Morph Ball Bomb

The Plated Parasites are well-armored versions Parasites. The best way to deal with them is to avoid them. If you need to get them out of your way, lay a Morph Ball Bomb and blow them off the walls.

Plated Puffer



Found In:
Chozo Ruins

Recommended Weapon:
Missile Launcher

Plated Puffers are better armored than Puffers. Missiles are very effective on these floating creatures. The gas released as you destroy them stays in the air for a few seconds after they disappear.

Plazmite

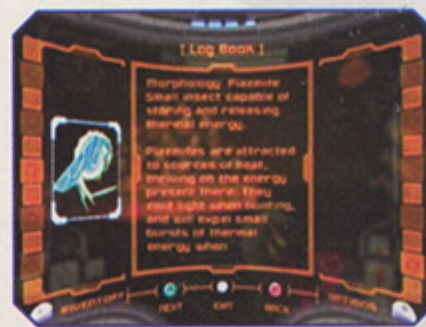

Found In:
Chozo Ruins

Recommended Weapon:
Power Beam

Plazmites are slow-flying creatures that light up the area with their energy-filled bodies. They are too slow to pose a real threat, and it's generally better to just let them be

unless they are in your way. In some places, the light they emit is very useful for looking around the room.

Power Trooper



Found In:
Phazon Mines

Recommended Weapon:
Power Beam

Power Troopers have stolen the Chozo technology for the Power Beam weapon. Their implementation of the design isn't as good as the original, but still packs quite a punch.

Their flawed design makes them vulnerable to Power Beam attacks. Use your Power Beam to blow the Power Troopers into oblivion. If you can manage it, it's best to use the Super Missile (Power Beam Combo) rather than dueling it out with these cretins. In a one-on-one fight, they can really dish out a lot of damage unless you can find excellent cover.

Puddle Spore

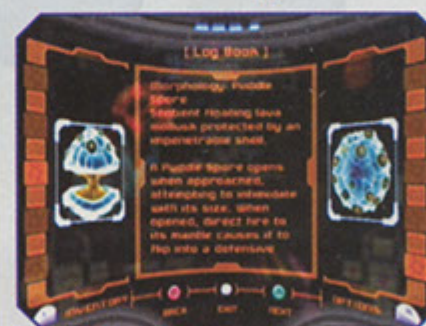

Found In:
Magmoor Caverns

Recommended Weapon:
Any

Puddle Spores populate the molten lava of Magmoor Caverns and cannot be destroyed. When one opens, shoot it in its mantle to flip it into its defensive position. Once the Puddle

Spore is in this position, you can use it as a platform to get across stretches of lava. If the Puddle Spore has an opportunity to close shut, it ejects a spread of harmful energy globules. These creatures cannot be destroyed.

Puffer



Found In:
Magmoor Caverns

Recommended Weapon:
Any

Puffers are filled with the lethal meta-viprium gas that is violently released when hit with any weapon. Shoot these floating creatures from afar; the gas they leave behind stays lethal for a few seconds after the Puffer is destroyed.

Pulse Bombu



Found In:
 Chozo Ruins, Phendrana Drifts

Recommended Weapon:
 Wave Beam

Pulse Bombus are floating electrical creatures invulnerable to most known weapons. The electric field it produces can cause your visors to malfunction if you get too close. The

only weapon that can destroy it is the Wave Beam. Unlike the related Scatter Bombus, Pulse Bombus drop pulse bombs. To get past them, shoot them with your Wave Beam or roll past between bomb drops. They can also attach to you in a way similar to a Metroid. If they do, quickly switch to Morph Ball mode and use a bomb to drive them off.

Ram War Wasp



Found In:
 Chozo Ruins

Recommended Weapon:
 Power Beam

Ram War Wasps appear during the boss fight with the Hive Mecha. They emerge in waves and spin around you before they position themselves in a circle. Their hive mind allows

them to all attack at once. Use your Power Beam to rotate with the Ram War Wasps and quickly fire at them. When they stop, use to lock on and shoot them before they get a chance to ram you. After you destroy each wave, aim for the Hive Mecha. You must repeat this with each wave of Ram War Wasps that issue from the Hive Mecha. See Hive Mecha also.

Reaper Vine

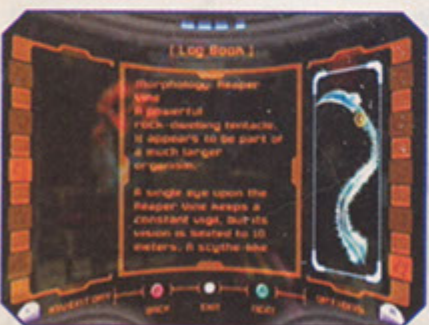

Found In:
 Chozo Ruins, Tallon Overworld

Recommended Weapon:
 Any

Reaper Vines protrude from holes in the walls or holes in the ground, or are simply planted in the ground. Shooting them only makes them retract for a short time. They are most commonly seen blocking your path. Shoot them and be on your way.

Sap Sac



Found In:
 Tallon Overworld

Recommended Weapon:
 Any

Sap Sacs are attached to tree trunks and branches. They don't move or bother you, and you can touch them all you want. Shoot them to cause a violent chemical explosion within the

Sap Sac. The explosion can destroy nearby enemies, but don't get too close yourself, or you'll feel their terrible wrath.

Scarabs



Found In:
 Chozo Ruins

Recommended Weapon:
 Any

Scarabs run in swarms and keep to small tunnels and corridors. Individually, they do not inflict much damage. In a swarm, they can drain your energy very quickly. Use the quick-firing Power Beam to destroy the swarm before walking through their numbers. If in a hurry, the Morph Ball can roll through a swarming group of Scarabs while taking minimal damage. This is best done before they settle on floor.

Scatter Bombu

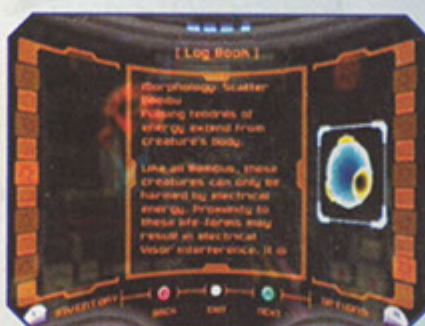

Found In:
 Chozo Ruins, Magmoor Caverns, Phendrana Drifts, Phazon Mines

Recommended Weapon:
 Wave Beam

Scatter Bombus are floating electrical creatures invulnerable to most known weapons. The electric field it produces can cause your visors to malfunction if you get too close. The Wave Beam is the only weapon that can destroy it. If you encounter a Pulse Bombu before you find the Wave Beam, change into the Morph Ball and roll between their electrical beams.

Seedling



Found In:
 Tallon Overworld

Recommended Weapon:
 Any

Seedlings are found feeding on the grounds of Tallon Overworld. When threatened, they fire their dorsal spines that home in on nearby targets. Seedlings are easily destroyed by a few shots from any weapon in your arsenal, but shoot fast or you'll be stung.

Sentry Drone



Found In:
 Phendrana Drifts, Phazon Mines

Recommended Weapon:
 Wave Beam

Sentry Drones are the Space Pirates' electrical security guards. When you are detected by a Sentry Drone, it locks the doors around you and tries to scramble your visor. Destroy them with your Wave Beam from a distance, or you won't be able to see.

Shadow Pirate



Found In:
Phendrana Drifts, Phazon Mines

Recommended Weapon:
Plasma Beam, Ice Beam

Shadow Pirates are equipped with high-tech cloaking devices; these suck up so much energy that nothing is left for any long-range weapons. Put on your Thermal Visor

to detect Shadow Pirates and shoot them from a distance. Once you hit them with your Plasma Beam, the fire is visible even if they are cloaked. If you prefer, freeze them with an Ice Beam blast and follow it up with a missile.

Space Pirate



Found In:
Space Pirate Frigate, Tallon Overworld, Phendrana Drifts, Phazon Mines

Recommended Weapon:
Missile Launcher

Space Pirates are the aggressive race of aliens performing all the twisted experiments you see in Metroid

Prime. From afar, they fire lethal cannons. Up close, they wield forearm-mounted scythes that are even more damaging. Although you can hurt them with any weapon, the Missile Launcher is the most effective. Shoot a couple missiles into their charging bodies.

Stone Toad



Found In:
Chozo Ruins

Recommended Weapon:
Morph Ball Bomb

Stone Toads sit and they sit. They also sit. They are harmless to everything except creatures smaller than themselves. When you are in Morph Ball mode, the Stone Toad will

suck you into its belly. Lay a Morph Ball Bomb while in its belly to blow up your would-be digester. If you don't yet have the Morph Ball Bomb, wait a few seconds for the Stone Toad to realize you're not so tasty after all and spit you out.

Tallon Crab

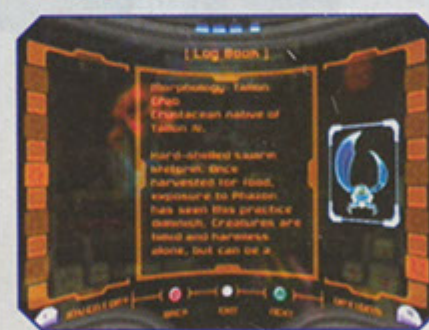

Found In:
Tallon Overworld

Recommended Weapon:
Any

Tallon Crabs come in never-ending swarms. You can't hope to destroy them all. Instead, destroy as many as you can, then just travel right through the swarm. The damage you

take is minimal if you reduce their numbers before diving in. Use the Morph Ball to add a little speed to your escape.

Tangle Weed

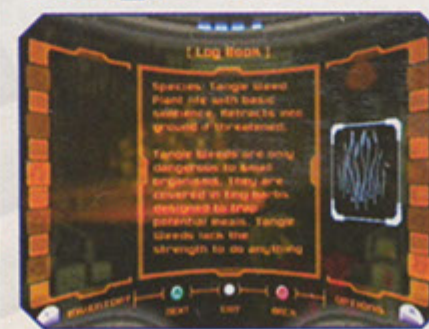

Found In:
Tallon Overworld, Chozo Ruins

Recommended Weapon:
Power Beam

This weed is harmless. All it does is slow you down when you pass through. You can shoot it to make it retract into the ground for a short time. Tangle Weed cannot be destroyed.

Sheegoth



Found In:
Phendrana Drifts

Recommended Weapon:
Plasma Beam, Missile Launcher

Weak Spot:
Mouth, side of head

The Sheegoth is a formidable foe. Not only is it invulnerable to most of your weapons, but the crystals

on its back absorb attacks to be fired out of its mouth. The more powerful the attack to its body, the more powerful a blast it can shoot back at you. Aim for the mouth or the side of the head with your Missile Launcher. If you have the Plasma Beam, you don't have to aim for the head and mouth; the Plasma Beam inflicts damage to all parts of its body. The Sheegoth is also armed with a frigid gas attack that can freeze you in your steps. Tap © repeatedly to escape.

Shriekbat



Found In:
Chozo Ruins, Phendrana Drifts

Recommended Weapon:
Power Beam

Shriekbats hang upside down from ceilings and are best detected by using your Thermal Visor. If you detect them while they still hang on the ceilings, you can pick them off

without danger. If you don't destroy them before they detect you, they launch a screeching attack toward where you stand. Use your quick-firing Power Beam to pick them off as they fly toward you. Once they are in the air, they cannot change direction. If you simply step out of the way, they go crashing into the spot where you once stood.



Thardus



Found In:
Phendrana Drifts

Recommended Weapon:
Missile Launcher, Charge Beam

Weak Spot: Varies

Thardus is a huge animated ice-and-rock creature infused with Phazon radiation. Because of this, it negates your auto-targeting system. Switch to your Thermal Visor to enable auto-targeting through heat sensing. With your Thermal Visor, you can lock on to Thardus's weak point and fire away. Missiles and the Charge Beam are very effective against Thardus's weak spots. Once the weak spot is destroyed and the Phazon core exposed, Thardus gives off so much heat that it overloads your Thermal Visor. Switch back to the Combat Visor immediately and lock on to its newly exposed Phazon core. Destroy the exposed Phazon with missiles and Charge Beam shots. Once it is destroyed, the heat subsides, and you can put your Thermal Visor back on to find the next weak spot. Tap repeatedly if you are caught in Thardus's ice attack, and use the Morph Ball to avoid it as it rolls around the arena.

Triclops



Found In:
Magmoor Caverns

Recommended Weapon:
Morph Ball Bombs

Triclops are small hunter-gatherers that collect small creatures and deposit them elsewhere for later consumption. Damage from Triclops is minimal whether or not you are in

Morph Ball. The real damage comes from them depositing you in a pool of lava. If you are picked up by a Triclops, roll in a circular motion to escape and drop a couple Morph Ball Bombs to destroy them. The Triclops will pick up the Morph Ball Bombs placed in front of them and be destroyed at detonation.

Venom Weed



Found In:
Tallon Overworld, Chozo Ruins

Recommended Weapon:
Any

Venom Weed ensnares anything that passes through it. Your movements are slowed, and the poison it excretes inflicts a steady amount of damage. Venom Weed cannot be

completely eradicated; it can only be forced to retract into the ground with a few shots from any of your weapons.

War Wasp

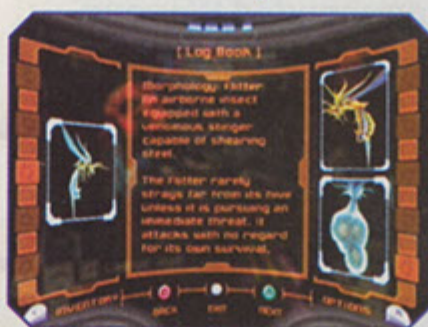

Found In:
Chozo Ruins

Recommended Weapon:
Any

War Wasps live in War Wasp Hives high on the walls of Chozo Ruins. Stirred up when you near their hive, they attack with their venomous stingers. They aren't very fast, and can be destroyed by a couple of Power Beam shots. They can be overwhelming if they swarm while you are standing on a ledge or platform. Destroy them all before they reach you, and don't forget to shoot a missile at the hive. See War Wasp Hive.

Wave Trooper



Found In:
Phazon Mines

Recommended Weapon:
Wave Beam

Wave Troopers are the Wave Beam-toting variation of beam Troopers. Their Wave Beam technology isn't as powerful as the one you're carrying, but it's still dangerous. Use the Wave Beam to destroy them before they get a chance to use their's on you. Use charged shots to stun them, then quickly use several more half-charged shots to finish them off; this way, they won't get a chance to fight back. When faced with multiple Wave Troopers, use the Wave Beam Combo to quickly lay waste to the entire group.

Zoomer

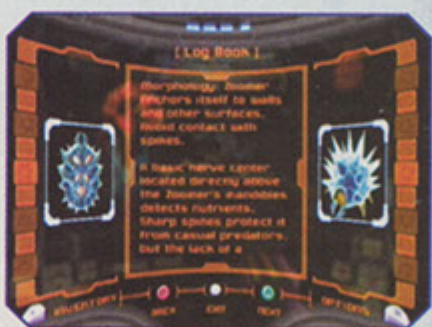

Found In:
Tallon Overworld, Magmoor Caverns

Recommended Weapon:
Any

Zoomers are spiky wall crawlers. They lack a particularly strong shell and can be destroyed by any one of your weapons. Zoomers aren't aggressive, because they are always busy scavenging for food. They don't pose much of a threat but can be a real annoyance when you are trying to navigate floating platforms and ledges. Don't waste missiles on them; destroy them with any other weapon.

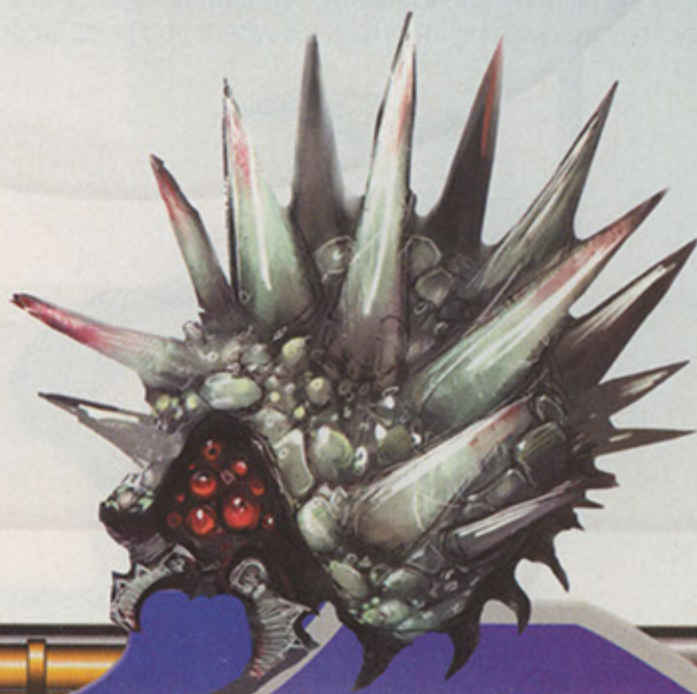



Upgrades and Log Book Entries

FINDING IT ALL

Here are complete listings of every upgrade, Pirate Data, Chozo Lore, and Research entry in the game. We tell you the world and room in which you can find them, and tell you any additional information you need to know about acquiring the item in question. The tables are broken up by type. You can also use this section to keep track of what you've found and see what you haven't.

Primary Upgrades

Upgrade	World	Room	Comments
Missile Launcher	Chozo Ruins	Hive Totem	Defeat Ram War Wasps and Hive Mecha
Morph Ball	Chozo Ruins	Ruined Shrine	Defeat Plated Beetle
Charge Beam	Chozo Ruins	Watery Hall	Solve rune puzzle
Morph Ball Bomb	Chozo Ruins	Burn Dome	Defeat Incinerator Drone
Boost Ball	Phendrana Drifts	Phendrana Canyon	Align the platforms
Space Jump Boots	Tallon Overworld	Alcove	Access through Tallon Canyon
Wave Beam	Phendrana Drifts	Chapel of the Elders	Defeat Sheegoth
Super Missile	Phendrana Drifts	Observatory	Activate holographic projector
Thermal Visor	Phendrana Drifts	Research Core	Deactivate force field with three switches
Spider Ball	Phendrana Drifts	Quarantine Cave	Defeat Thardus
Wavebuster	Chozo Ruins	Tower of Light	Destroy cracked supports
Ice Beam	Chozo Ruins	Antechamber	Activate Chozo statue in Hall of the Elders
Gravity Suit	Phendrana Drifts	Gravity Chamber	Look for it underwater
Power Bomb	Phazon Mines	Central Dynamo	Pass through maze
Grapple Beam	Phazon Mines	Storage Depot (off Ore Processing)	Realign tower in Ore Processing
X-ray Visor	Tallon Overworld	Life Grove	Use Power Bomb to gain access
Ice Spreader	Magmoor Caverns	Shore Tunnel	Destroy bridge with Power Bomb
Plasma Beam	Magmoor Caverns	Plasma Processing (off Geothermal Core)	Solve Geothermal Core puzzle
Flamethrower	Phazon Mines	Storage Depot A (off Mine Security Station)	Open control room with Power Bomb to deactivate force field
Phazon Suit	Phazon Mines	Elite Quarters	Defeat Omega Pirate



Pirate Data

✓ Data Name	World	Room
Metroid Prime	Phazon Mines	Elite Control
Mining Status	Phendrana Drifts	Research Lab Hydro
Artifact Site	Tallon Overworld	Temple Security Station
Special Forces	Phazon Mines	Metroid Quarantine B
Metroid Forces	Phendrana Drifts	Research Lab Aether
Chozo Studies	Phazon Mines	Elite Control
Fall of Zebes	Space Pirate Frigate	Biohazard Containment
Prime Mutations	Phazon Mines	Elite Control
Security Breaches	Phendrana Drifts	Research Lab Hydro
Phazon Analysis	Phendrana Drifts	Research Lab Hydro
Omega Pirate	Phazon Mines	Omega Research
Contact	Phendrana Drifts	Observatory
Chozo Ghosts	Phazon Mines	Elite Control
Prime Breach	Phazon Mines	Elite Control
Parasite Larva	Phendrana Drifts	Research Lab Hydro
Meta Ridley	Phendrana Drifts	Research Lab Aether
Phazon Program	Phendrana Drifts	Observatory
Metroid Morphology	Phendrana Drifts	Research Lab Aether
Chozo Artifacts	Phazon Mines	Elite Control
Phazon Infusion	Phazon Mines	Research Lab Aether
Metroid Studies	Phendrana Drifts	Research Lab Aether
The Hunter	Phazon Mines	Elite Control
Elite Pirates	Phazon Mines	Elite Research
Glacial Wastes	Phendrana Drifts	Research Lab Hydro
Hunter Weapons	Phazon Mines	Elite Control



Chozo Lore

✓ Lore Name	World	Room	Comment
Infestation	Chozo Ruins	Crossway	
Binding	Tallon Overworld	Artifact Temple	
Cradle	Chozo Ruins	Furnace	
Beginnings	Chozo Ruins	Vault	
Cipher	Phendrana Drifts	Ice Ruins West	In the building to the right of where you enter - easy to miss
Worm	Chozo Ruins	Crossway	
Fountain	Chozo Ruins	Ruins Entrance	
Exodus	Chozo Ruins	Ruined Nursery	
Hatchling's Shell	Chozo Ruins	Crossway	
Hatchling	Chozo Ruins	Ruined Fountain	
Meteor Strike	Chozo Ruins	Watery Hall	
Contain	Chozo Ruins	Sun Tower	
The Turned	Phendrana Drifts	Phendrana Canyon	Look under the door where you enter
Hope	Chozo Ruins	Hall of the Elders	
Statuary	Tallon Overworld	Artifact Temple	
Newborn	Chozo Ruins	Magma Pool	In hidden chamber near the Power Bomb Expansion

Research

✓ Entry Name	Comments
Save Station	Scan any of the Save Stations throughout the game.
Missile Door Lock	Scan any door that requires a missile to open <i>before</i> you shoot it.
Map Station	Scan any of the Map Stations throughout the game <i>before</i> you use it.
Spinner	Scan an active Spinner to add it to your Log Book.
Missile Ammunition	Scan any Missile Ammunition dropped by enemies or found in crates
Large Energy	Scan any Large Energy dropped by enemies or found in crates. Large Energies are red.
Small Energy	Scan any Small Energy dropped by enemies or found in crates. Small Energies are blue.
Stalactite	Scan the Stalactites <i>before</i> you shoot them down to form bridges or platforms.
Missile Station	Scan a Missile Station <i>before</i> you reload your Missile Launcher.
Spider Ball Track	Scan the magnetic Spider Ball tracks once you have the Spider Ball upgrade.
Power Bomb Ammo	Scan a Power Bomb Ammo dropped by enemies or found in crates.
Grapple Point	Scan the Grapple Point <i>after</i> you get the Grapple Beam.
Zebes	Scan the planet Zebes in Phendrana Drifts' Observatory.
Ultra Energy	Scan any Ultra Energy dropped by enemies or found in crates. Ultra Energies are yellow.
Morph Ball Slot	Scan an active Morph Ball slot.
Tallon IV	Scan the planet Tallon IV in Phendrana Drifts Observatory.
Locked Door	Locked Doors prevent you from leaving an area until you defeat an enemy within. These doors are locked when you first find them: entrance to the Hall of the Elders in Chozo Ruins, the door across from the entrance to the Control Tower in Phendrana Drifts.
Gunship	Scan Samus's ship at the Landing Site in Tallon Overworld.

Artifacts

Artifact	World	Room	Requires
Truth	Tallon Overworld	Artifact Temple	Missile Launcher
Strength	Magmoor Caverns	Warrior Shrine	Space Jump Boots and Morph Ball
Elder	Phendrana Drifts	Control Tower	Plasma Beam, Space Jump Boots, Missile Launcher, and Morph Ball
Wild	Chozo Ruins	Sunchamber	Super Missile and Spider Ball
Lifegiver	Chozo Ruins	Tower Chamber (off Tower of Light)	Gravity Suit and Space Jump Boots
Warrior	Phazon Mines	Elite Research	Power Bomb
Chozo	Tallon Overworld	Life Grove	Power Bomb and X-ray Visor
Nature	Magmoor Caverns	Lava Lake	X-ray Visor and Super Missile
Sun	Phendrana Drifts	Chozo Ice Temple	Plasma Beam and Morph Ball
World	Chozo Ruins	Elder Chamber (off Hall of the Elders)	Plasma Beam
Spirit	Phendrana Drifts	Storage Cave (off Phendrana's Edge)	Grapple Beam, X-ray Visor, Power Bomb, and Plasma Beam
Newborn	Phazon Mines	Phazon Mining Tunnel	Phazon Suit and Morph Ball Bomb

Missile Expansions

World	Room	Requires	Comments
Tallon Overworld	Landing Site	Morph Ball	Small tunnel behind ship
Tallon Overworld	Root Cave	Grapple Beam and X-ray Visor	Alcove near the top, look for invisible platforms
Tallon Overworld	Arbor Chamber	Grapple Beam, X-ray Visor, and Ice Beam	Room at the very top of Root Cave
Tallon Overworld	Transport Tunnel B	Varia Suit	Under bridge
Tallon Overworld	Frigate Crash Site	Gravity Suit and Space Jump Boots	Underwater alcove near center
Tallon Overworld	Overgrown Cavern	Morph Ball	In tunnel between Venom Weed
Tallon Overworld	Biohazard Containment	Gravity Suit and Super Missile	Locked in closed containment capsule
Tallon Overworld	Great Tree Chamber	X-ray Visor and Space Jump Boots	Look for hidden platform and room behind tree
Tallon Overworld	Life Grove Tunnel	Boost Ball and Morph Ball Bomb	Blow hole in top of oval rock and drop in
Chozo Ruins	Main Plaza	Boost Ball	Above half pipe and under bridge
Chozo Ruins	Main Plaza	Space Jump Boots and Super Missile	Under knot in large tree
Chozo Ruins	Main Plaza	Grapple Beam	Must come through the Magma Pool to reach proper spot
Chozo Ruins	Ruined Shrine	Morph Ball Bomb	Through small tunnel at base of room
Chozo Ruins	Ruined Shrine	Morph Ball and Boost Ball	In small room at top of half pipe
Chozo Ruins	Ruined Nursery	Morph Ball Bomb	In maze along wall
Chozo Ruins	Ruined Gallery	Missile Launcher	Behind brick wall at bottom
Chozo Ruins	Ruined Gallery	Morph Ball Bomb	Inside small tunnel near bottom
Chozo Ruins	Vault	Morph Ball Bomb	Unlock cage in center (Double Bomb Jump required)
Chozo Ruins	Ruined Fountain	Spider Ball	Drop into fountain to be shot up to magnetic rail

Missile Expansions cond.

World	Room	Requires	Comments
✓ Chozo Ruins	Training Chamber Access	Morph Ball and Grapple Beam	Look for hidden tunnel behind large plant
Chozo Ruins	Gathering Hall	Space Jump Boots and Morph Ball Bomb	Look for alcove above door at top
Chozo Ruins	Watery Hall Access	Missile Launcher	Behind brick wall at bottom
Chozo Ruins	Watery Hall	Gravity Suit and Space Jump Boots	In underwater alcove
Chozo Ruins	Dynamo	Morph Ball Bomb, and Charge Beam	Through tunnel from Watery Hall—shoot metal grate with Charge Beam
Chozo Ruins	Dynamo	Morph Ball Bomb, Space Jump Boots, and Spider Ball	Through tunnel from Watery Hall—use magnetic rail
Chozo Ruins	Burn Dome	Morph Ball and Morph Ball Bomb	Small tunnel in back of room after boss
Chozo Ruins	Furnace	Spider Ball, Power Bomb, and Speed Ball	Destroy portion of floor, use half pipe to reach magnetic rails
Chozo Ruins	Crossway	Super Missile, Boost Ball, and Spider Ball	Blast wall decoration, use half pipe to reach Morph Ball slots
Magmoor Caverns	Triclops Pit	X-ray Visor and Super Missile	Look for invisible platforms in the center and destroy pillar at end
Magmoor Caverns	Storage Cavern	Morph Ball	Through Morph Ball tunnel in Triclops Pit
Magmoor Caverns	Fiery Shores	Morph Ball Bomb	Ride rail over lava
Phendrana Drifts	Phendrana Shorelines	Plasma Beam	Trapped in a pillar near the Save Station
Phendrana Drifts	Phendrana Shorelines	Space Jump Boots, Super Missile, Morph Ball Bomb, and Spider Ball	Destroy metal adornment on temple, climb tower
Phendrana Drifts	Ice Ruins East	Spider Ball	Look for magnetic rail on top of building
Phendrana Drifts	Ice Ruins East	Plasma Beam	Melt ice on side of building
Phendrana Drifts	Research Lab Hydra	Super Missile	Blast column
Phendrana Drifts	Research Lab Aether	Space Jump Boots and Morph Ball	Slender ledge over stairs
Phendrana Drifts	Quarantine Monitor	Grapple Beam	Cross Quarantine Cave with Grapple Beam
Phendrana Drifts	Frost Cave	Grapple Beam and Missile Launcher	Use Grapple Beam to ledge with crates, shoot down top stalactite, item in water
Phendrana Drifts	Gravity Chamber	Plasma Beam and Grapple Beam	Melt ice at cave's top to reveal Grapple Point
Phazon Mines	Main Quarry	Spider Ball, Thermal Visor, and Wave Beam	Look for power conduit near crane, adjust crane and use magnetic rail
Phazon Mines	Security Access A	Power Bomb	Destroy metal cage in corner
Phazon Mines	Elite Control Access	Space Jump Boots and Morph Ball	Destroy explosive crate near vent over room
Phazon Mines	Metroid Quarantine A	X-ray Visor, Spider Ball, and Space Jump Boots	Destroy walls near magnetic rail, follow path to item
Phazon Mines	Fungal Hall Access	Phazon Suit	Look under mushroom at bottom
Phazon Mines	Fungal Hall	Power Bomb	Look for mushroom ring below door, use Power Bomb
Phazon Mines	Metroid Quarantine B	Super Missile	Blast column
Phazon Mines	Phazon Processing Center	X-ray Visor, Space Jump Boots, and Power Bomb	Look for invisible platforms in center of room, item trapped in wall near top platform
Phazon Mines	Elite Research	Boost Ball	Use the industrial grade Pulse Beam



Energy Tanks

World	Room	Requires	Comments
Tallon Overworld	Cargo Freight Lift to Deck Gamma	Charge Beam and Gravity Suit	Blast door of broken lift
Tallon Overworld	Hydro Access Tunnel	Morph Ball Bomb and Gravity Suit	Double Bomb Jump to top of tunnel
Chozo Ruins	Transport Access North	Missile Launcher	Pick up after boss in Hive Totem
Chozo Ruins	Main Plaza	Morph Ball	Access via Plaza Access tunnel
Chozo Ruins	Training Chamber	Speed Ball, Spider Ball, and Morph Ball Bomb	Use half pipe to reach Morph Ball slot on right, use lift
Chozo Ruins	Furnace	Morph Ball	Solve Morph Ball slot puzzle in Energy Core to gain access
Chozo Ruins	Hall of the Elders	Morph Ball and Ice Beam	Use Ice Beam slot and Chozo statue
Magmoor Caverns	Transport Tunnel A	Morph Ball Bomb	Double bomb jump to top of tunnel
Magmoor Caverns	Magmoor Workstation	Thermal Visor, Wave Beam, and Morph Ball	Restore power to machinery, solve tunnel maze
Phendrana Drifts	Ruined Courtyard	Morph Ball Bomb	Raise water and drop into yellow Morph Ball tunnel on opposite side
Phendrana Drifts	Research Lab Aether	Missile Launcher	Item in containment vat
Phendrana Drifts	Transport Access	Plasma Beam	Melt ice to reach item
Phazon Mines	Ventilation Shaft	Power Bomb	Destroy ground near fan to reach fan controls
Phazon Mines	Processing Center Access	Phazon Suit	Pick up after Omega Pirate battle

Power Bomb Expansions

World	Room	Requires	Comments
Chozo Ruins	Magma Pool	Grapple Beam and Power Bomb	Destroy back wall
Magmoor Caverns	Warrior Shrine	Space Jump Boots, Boost Ball, and Power Bomb	Destroy metal plate in front of statue
Phendrana Drifts	Security Cave (off of Phendrana's Edge)	Grapple Beam and Morph Ball	Climb to top of Phendrana's Edge, use tunnel
Phendrana Drifts	Ice Ruins West	Plasma Beam	Melt ice on top of building

Metroid Prime Game Secrets

So now that you've beaten *Metroid Prime*, you're wondering if you've unlocked everything. Did you get the best possible ending? How do you unlock all of the Image Galleries? What's this about connecting *Metroid Fusion* for the Game Boy Advance to *Metroid Prime*? The answers to these questions and more are revealed here.

ENDINGS

There are three possible endings to *Metroid Prime*: Worst, Bad, and Best. What ending you see when you complete the game depends on the percentage of item pick-ups. Every item that you pick up throughout the game is counted toward the item percentage (except for Energy and ammo dropped by creatures or found in crates). Missing an item? Check out the previous chapter, "Upgrades and Log Book Entries," to look up what you're missing.

Item Pick-Ups	Ending
0-74%	Worst ending
74-99%	Bad ending
100%	Best ending

NOTE

Some creatures can appear only once or twice in the game. This is especially true for bosses. If you miss your chance to scan them, you're out of luck. There is also one Pirate Data entry in the Space Pirate Frigate that you cannot return to once you leave the Frigate. Scan everything, all the time.

HARD MODE

Hard Mode is unlocked after you beat the game once. In Hard Mode, the enemies are tougher to damage, and you are more vulnerable to attacks and damage from harmful substances.

IMAGE GALLERY

You can unlock up to four Image Galleries in *Metroid Prime*. Each is unlocked upon completion of a certain percentage of the game. One Image Gallery is opened for completing each of the following requirements.

- 50 percent of scans (Log Book entries)
- 100 percent of scans (Log Book entries)
- 100 percent of pick-ups (all items except Energy and missile ammo dropped by enemies or crates)
- Beating Hard Mode

To access the Image Galleries, you must exit the game and go to the Loading screen.

CONNECTING METROID FUSION FOR THE GAME BOY ADVANCE

If you also have *Metroid Fusion* for the Game Boy Advance, you're in for a real treat. After completing at least one of the two games, all you need is a Game Link Cable to link your Game Boy Advance to your GameCube.

NES Metroid



Once you complete *Metroid Fusion* on the Game Boy Advance, go to the load screen in *Metroid Prime* and select "Metroid Fusion Connection Bonuses." From there, just follow the onscreen directions and you'll soon be reliving video game history. NES *Metroid* can now be played on your GameCube.



Metroid Fusion Suit

Once you complete *Metroid Prime* and connect *Metroid Fusion* to your GameCube via the Game Link Cable, you will unlock the *Metroid Fusion* Suit for *Metroid Prime*. Follow the onscreen directions from the *Metroid Prime* Loading screen to connect the Game Boy Advance to your GameCube. Once it's all loaded, you can choose the suit that Samus wears in *Metroid Fusion*!



METROID FUSION

Meet Samus Aran

INTRODUCTION

It has been eight years since the most famous bounty hunter in the universe, Samus Aran, answered a frantic distress call from the Space Science Academy on the Galactic Federation Space Colony. She had last been there to deliver a Metroid larva to eager scientists. But, when she returned, the research facility was in ruin, and the Metroid larva was missing. She soon found out why. Out of the rubble came a gang of Zebesian space pirates, led by Ridley, a giant pterodactyl. With the Metroid larva in their possession, the gang fled to their newly rebuilt planet Zebes. Samus had defeated the Metroids before, and she would do it again.

Now, in *Metroid Fusion*, Samus is needed again, but this time the enemies are vicious and unpredictable. And, to make matters worse, Samus Aran must begin the battle without her most powerful attributes.

Fortunately, Prima Games is here to help, with a comprehensive guide to every level, including detailed maps that reveal the locations of all 100 energy and weapon power-ups. Conquering *Metroid Fusion* depends on how quickly you can recover Samus's abilities, but even more importantly, how well you use them. In this guide, we provide tips for getting the most out of each new weapon and ability. We show you shortcuts and hidden pathways, and when you come face-to-face with powerful bosses like Serris and Yakuza, we deliver battle strategies to help you balance the odds in Samus's favor.

Before we begin the walkthrough, a little training is in order. In this section, we cover Samus's new abilities and weapons. Next, we explain the Special Blocks that appear in the floors, ceilings, and walls of Biologic Space Labs. These blocks are almost always hidden, so we tell you how to find them, what they mean, and how to use Samus's abilities to take advantage of each one. That brings us to the walkthrough. We take you level by level, from Samus's arrival at Biologic Space Labs to her eventual, and surprising, departure.

Enough chatter; let's get to work. The X parasites are infecting everything in sight.

SAMUS ARAN'S LOST WEAPONS AND ABILITIES

As you progress through *Metroid Fusion*, Samus regains lost abilities through data downloads from Biologic Headquarters, or by destroying and then absorbing a Core-X. The following weapon and ability upgrades are listed in their order of appearance in the game.

Missile

Location: Main Deck

Acquired By: Data download

Controls: Hold [R] and tap [B]



Stronger than a normal beam (Samus's default weapon), a missile shot is recommended for targeting the larger enemies early in the game. Unlike a beam, which has an endless supply of energy, Samus packs a limited number of missiles. You can increase this capacity by finding Missile Tank power-ups. Missiles of any kind can destroy all Missile Blocks.



Charge Beam

Location: Sector 1

Acquired By: Defeating Elephant Bird

Controls: Hold [B], release when energy reaches maximum level (you can hear it)

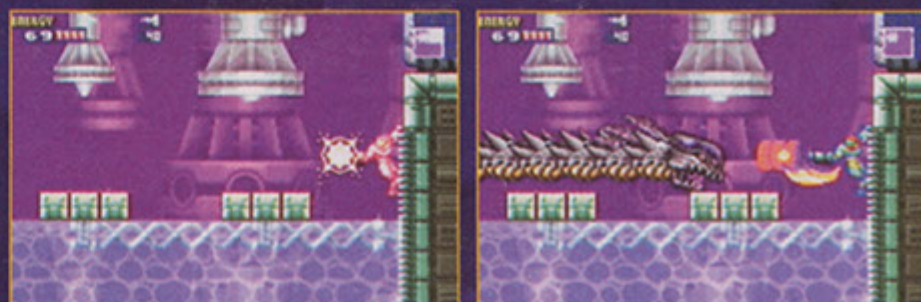

When fully charged, a Charge Beam packs a bigger wallop than a quick burst. Although this shot requires timing, especially when battling a boss, it can save Samus's hide when she is out of missiles. Don't forget, you can charge up a beam while running or jumping, and keep it charged until you are ready to release the shot.

Bomb

Location: Sector 2

Acquired By: Data download

Controls: While in Morph Ball mode, press **Ⓞ**

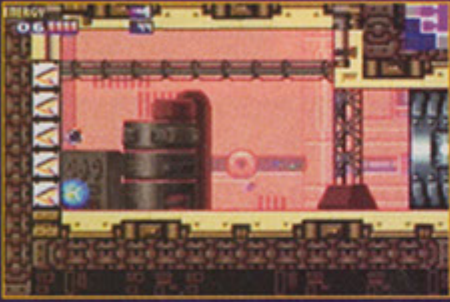
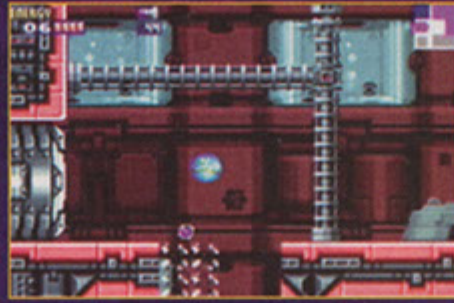
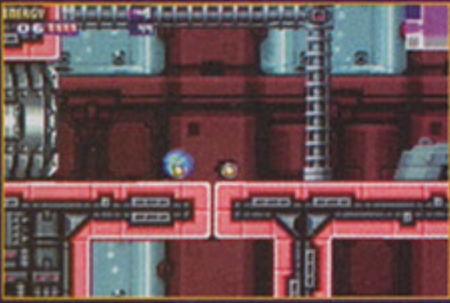

Early in the game, this is your most important weapon for finding Special Blocks and hidden openings in floors, walls, and ceilings. Bombs will also destroy many barriers, but only one block at a time. No worries: Samus has an unlimited supply of bombs, so don't hesitate to spread them over

every inch of a surface to see what's there. You can also jump and leave a bomb in midair, a required strategy for finding certain pathways and Special Blocks.

TIP

Bombs can only destroy Bomb Blocks, not Power Bomb Blocks, so make sure you check the Special Block symbol if you run into a problem.

High Jump and Jump Ball

Location: Sector 2

Acquired By: Defeating Giant Plant

Controls: Tap + Control Pad **↔**

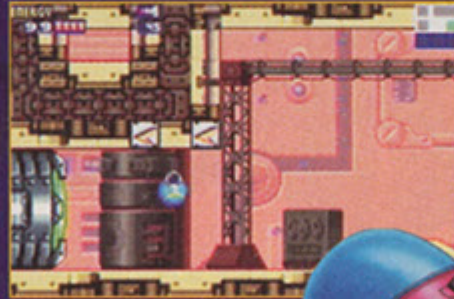
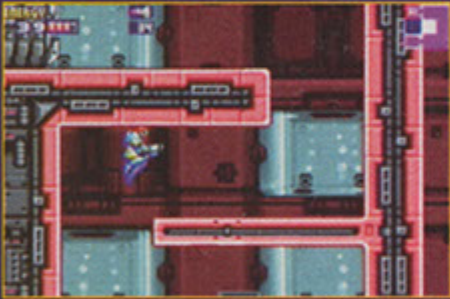

High Jump allows Samus to reach taller ledges, and Jump Ball enables her to bounce higher in Morph mode. Jump Ball is especially useful for planting bombs in high places.

Speed Booster

Location: Sector 4

Acquired By: Defeating Serris

Controls: Hold + Control Pad in the direction you want to run



As soon as you acquire Speed Booster, start looking for Boost Blocks everywhere if you want to progress. The key to using this ability is to clear an adequate path so Samus can reach top speed. This means killing enemies, blowing up barriers, and opening doors. Samus must run for a minimum distance before the Speed Booster kicks in, so any decrease in speed aborts the process.



TIP

If you clear a room prior to using Speed Booster, don't leave the room, or all enemies and barriers will be restored, and you'll have to repeat the process. Also, don't forget to keep your finger on the beam button as you run toward a hatch so it will be open by the time you get there.

Super Missile

Location: Sector 3

Acquired By: Data download

Controls: Hold **Ⓡ** and tap **Ⓞ**

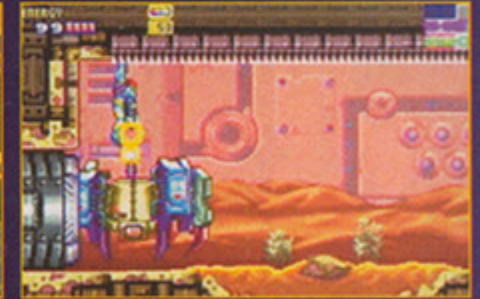

A Super Missile packs a bigger punch than a regular missile, and it is the recommended weapon against the first Security Robot. However, quantities are limited, so finding hidden Missile Tanks is critical to your success.



Varia Suit

Location: Sector 6

Acquired By: Defeating Core-X

Controls: N/A



After running from the blue X in Sector 6, you'll be thrilled to acquire the Varia Suit, because it enables Samus to absorb the little floaters. This upgrade also gives Samus added protection against all enemy attacks, and specifically prevents damage from high- or low-temperature environments.

Ice Missile

Location: Sector 5

Acquired By: Data download

Controls: Hold **R** and tap **B**

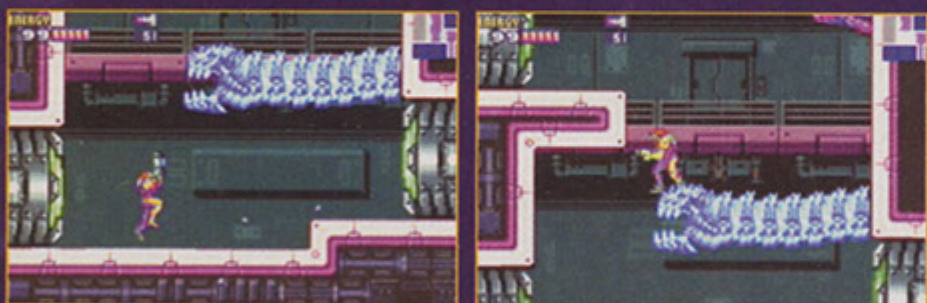

This unique upgrade allows you to freeze any regular enemy (except bosses). You can even freeze the SA-X for a short time. However, it is most useful for freezing dangerous plants, so you can climb on them, or for shooting Rippers

as they move back and forth across a room. A frozen Ripper makes a perfect stepping stone. Even a mighty Fune can be frozen when it is fully extended from a wall. While a creature is frozen, another Ice Missile will usually destroy it. If you don't fire again, the enemy will eventually thaw out and return to normal, so don't take too long to execute your maneuver.

Wide Beam

Location: Sector 3

Acquired By: Defeating Beam Core-X

Controls: Tap **@**



This enhanced attack shoots three energy beams, giving you a much wider field of attack. It is a necessity for clearing rooms crowded with crawling and flying enemies.

Power Bomb

Location: Sector 5

Acquired By: Data download

Controls: While in Morph mode, hold **R** and tap **@**



This is quite possibly the most important weapon in the game. A Power Bomb lays waste within a wide radius, neutralizing creatures, pulverizing barriers, and revealing (or destroying) any Special Blocks in the vicinity. Unlike regular bombs, these weapons are limited, so you should always take the time to find and recover Power Bomb Tanks to increase Samus's capacity.

TIP

Like a regular bomb, the effects of a Power Bomb are repaired if you leave a room after detonating it. If you must leave the room to execute a strategy, like Speed Booster, take a moment to study the locations of Special Blocks or openings so you can return to them without wasting another Power Bomb.



Space Jump

Location: Main Deck

Acquired By: Defeating Yakuza

Controls: Perform consecutive Spin Jumps: Tap \diamond while pressing + Control Pad in any direction)

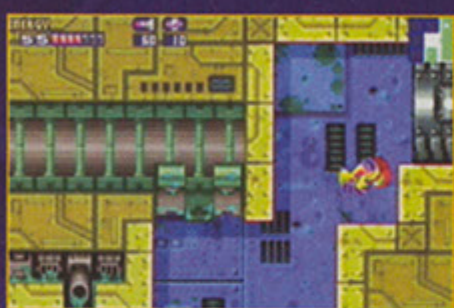
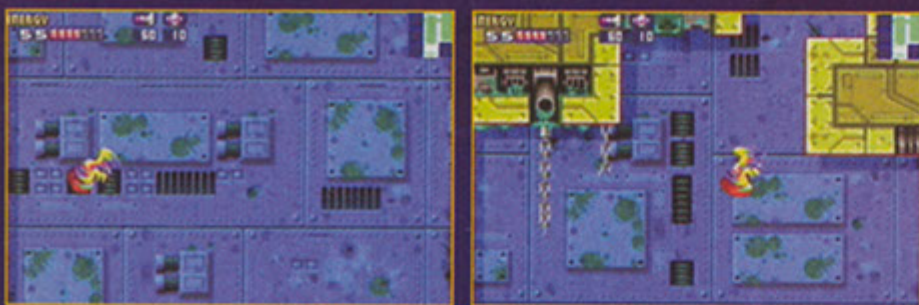

Unlike most weapon and ability upgrades, Space Jump requires some practice before you can use it effectively. The exact timing is sometimes elusive, even after you've used it extensively, so you must experiment with the amount of pressure you use on the + Control Pad. In a large room, it is best to go back and forth as you climb. However, you can also use a wall to your advantage. Continue aiming the Space Jump at the wall, and Samus will slide upward. The toughest maneuver is to get through a small opening. You must tap very quickly to keep Samus moving up while maintaining proper direction.

Just line up the creatures when you have Plasma Beam. This attack goes through an enemy like a hot knife through butter, so be sure to lay on the Plasma Beam when the path ahead is filled with infected creatures.

Plasma Beam

Location: Sector 2

Acquired By: Defeating Nettori

Controls: Tap \odot



Just line up the creatures when you have Plasma Beam. This attack goes through an enemy like a hot knife through butter, so be sure to lay on the Plasma Beam when the path ahead is filled with infected creatures.

Gravity Suit

Location: Sector 5

Acquired By: Defeating Nightmare

Controls: N/A



Although Samus is able to breathe underwater, she moves very slowly. With the Gravity Suit, Samus can execute any maneuver at full speed, even while submerged. The suit also protects her from lava damage, and it provides a little extra padding against all enemy attacks.

Diffusion Missile

Location: Sector 4

Acquired By: Data download

Controls: Hold \square until charged, then tap \odot

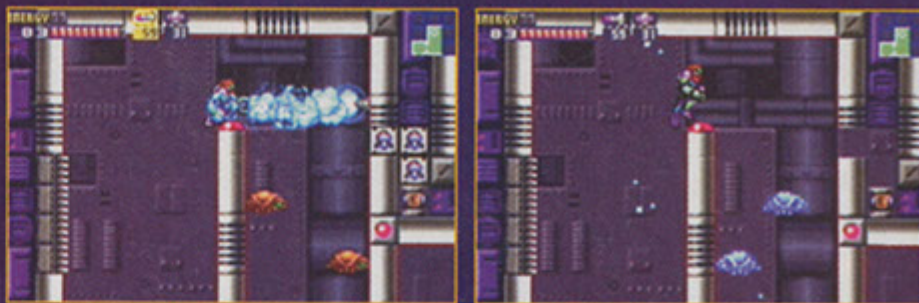

This weapon is a lifesaver, especially when a squad of Rippers blocks your path. One shot freezes everything within the blast radius. A Diffusion Missile is the answer against inflatable bombs that block Samus's path every time she approaches. Wait until the bombs are deflated, then freeze them with a Diffusion Missile, allowing Samus to walk or roll by.

Wave Beam

Location: Sector 6

Acquired By: Defeating Security Robot

Controls: Tap \odot

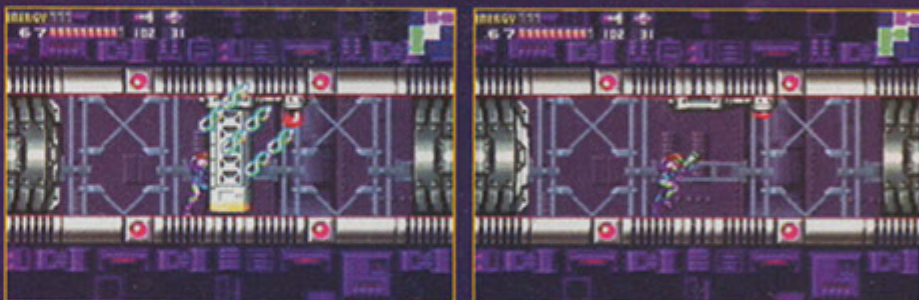

The powerful Wave Beam shoots through any object, including walls. It is most useful for opening shutters, because you can shoot through the closed shutter to hit the control light on the other side. You can also shoot through barriers and kill enemies before they see you. However, this ability also prevents a Wave Beam from locating a false wall, because every shot passes through whether or not the wall is real. Unfortunately, you can't go back to a regular beam after unlocking Wave Beam, so you must manually examine walls for secret pathways.

Screw Attack

Location: Sector 1

Acquired By: Defeating Ridley

Controls: Hit enemies with Spin Jump: Tap \diamond while pressing + Control Pad in any direction

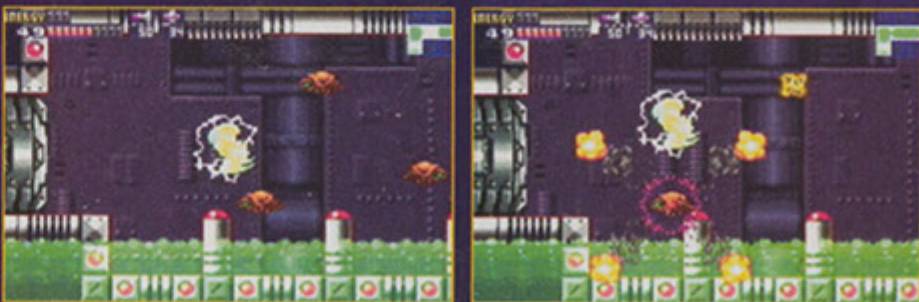

This is the complete package. Don't even worry about regular enemies once you gain Screw Attack, because you can spin through and destroy anything without fear. Be on the lookout for Screw Attack Blocks. You'll be able to smash through these blocks on the walls, ceilings, or floors.

Special Blocks

As you move through Biologic Space Labs, you will encounter impassable areas. Or not. A wall, ceiling, floor, or barrier may seem to be a dead end. However, if you know where and how to look, you can uncover Special Blocks that hold the solutions to your navigational dilemmas. Read on for more *Metroid Fusion* secrets.

Fake Blocks



Fake Blocks come in two flavors. The first version looks like a bad repair job. The blocks are wrinkled, cracked, or otherwise out of sync with their surroundings. When you see one, destroy it with a Bomb or Beam to open a secret path. The other type of Fake Block is only revealed when you use a Bomb or Power Bomb. After the explosion, a

Fake Block will turn gray, and it looks like it has been punched in the middle. It is important to remember that these blocks look completely normal until you use a bomb to reveal their positions.

Pit Blocks



Power Bomb Tank acquired.
Power Bomb capacity increased.

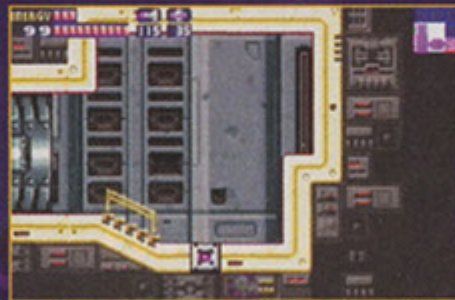

These blocks crumble and disappear when Samus steps on them. Like Fake Blocks, they are revealed after an explosion. However, they are still functional, even when you don't see them. So, don't be surprised if Samus falls through what looks like a perfectly normal floor.

Missile Blocks



These blocks can only be removed with a Missile blast. Look for Missile Blocks everywhere, including the floor, where you need to jump up and aim your shot straight down while Samus is still airborne.

Boost Blocks



A Boost Block can only be destroyed when Samus is using Speed Booster. The easiest technique is to simply clear a room of obstacles and enemies, and run in the direction of the Boost Blocks. If Speed Booster is engaged, Samus will blast through the blocks. This will get you through most of the early Boost Block placements.



However, as you advance through the levels, you'll need to master the art of changing direction in the middle of a Speed Booster run. In the sequence pictured above, the first step is to solve the puzzle of connecting the platforms (this is explained in the walkthrough). After running to initiate Speed Booster, you must pause (tap ↓ on the + Control Pad). Next, tap Ⓐ to jump up to the level of the Boost Blocks. Finally, continue Speed Booster by pressing and holding → on the + Control Pad.

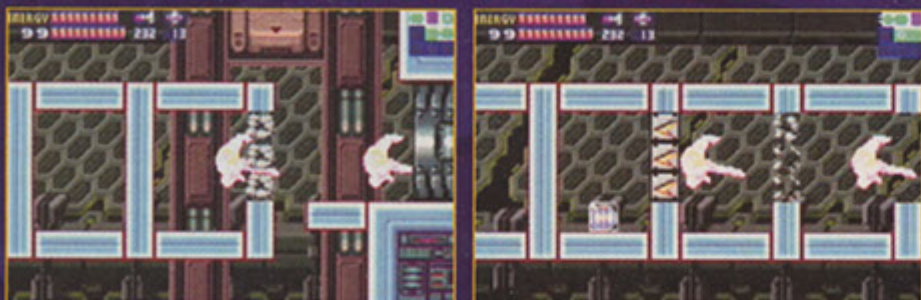

Some Speed Booster runs must sustain through several sets of Boost Blocks, as pictured above. So, don't give up on the run until Samus slams into something solid.

NOTE

You can pause a Speed Booster run at any time, by tapping ↓ on the + Control Pad, which forces Samus into a crouch. You have a couple seconds to resume the run by tapping the Jump key Ⓐ (Samus lifts her feet). Continue the Speed Booster by pressing one of the directional buttons on the + Control Pad (this includes ←, →, ↶, and ↷ for angled movement). You can repeat this process an unlimited number of times, as long as Samus does not hit a wall or obstacle.

While Samus is in a crouch, you can also morph into a ball to navigate tight quarters. When you want to return to Samus's normal form, tap + Control Pad ↓ again, and then repeat the process to resume the run. Hence, when you uncover Boost Blocks, you must examine all possible routes to your target. In the later levels, this is rarely a straight path.

Bomb Blocks



Bomb Blocks can appear anywhere on the map, including the floor, walls, and ceiling. You may need to jump up, or over, to place a Bomb in the proper position to explode the block.

Power Bomb Blocks



Regular Bombs will uncover Power Bomb Blocks, but they will not explode them. During the first nine levels, you will find many of these blocks, but until you receive the Power Bomb data, they will stay in place.

Screw Attack Blocks

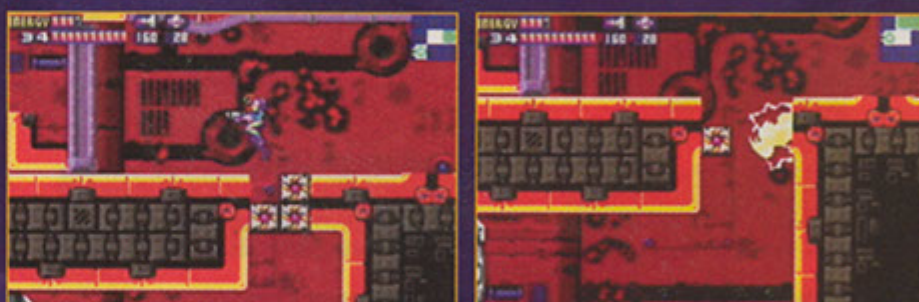

When Samus spin jumps into a wall with Screw Blocks, the wall comes down. These blocks can be found anywhere in a room, so it is a good idea to use Screw Attack as a normal mode of transportation, especially during the last few levels.



Main Deck

- Legend**
- S - Save Room
 - N - Navigation Room
 - D - Data Room
 - R - Recharge Room
 - M - Missile Tank
 - E - Energy Tank
 - B - Bombs
 - X - Security Access
 - ⊙ - Bosses
 - Ladders
 - Red - Explorable
 - Green - Hidden Areas

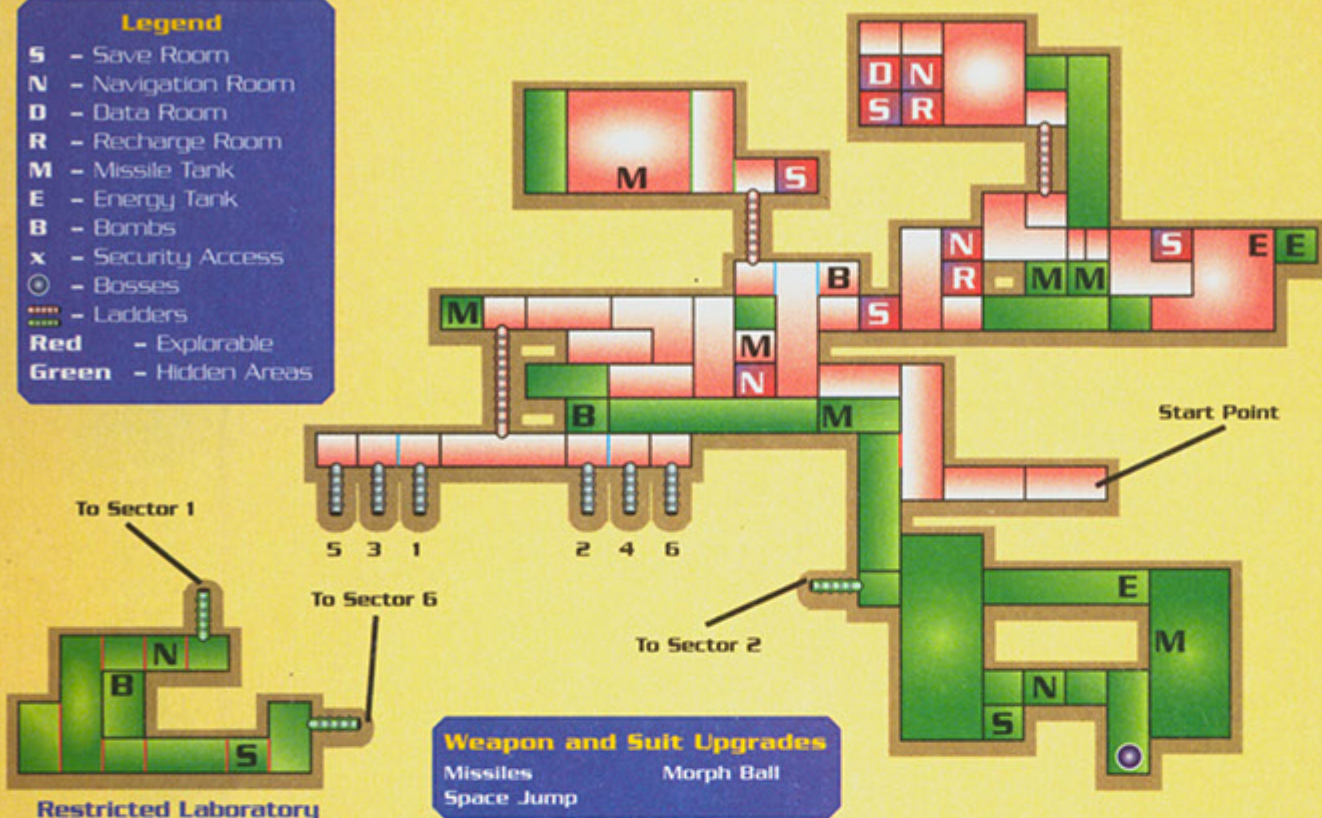

QUARANTINE BAY

Objective

There's been an explosion in the Quarantine Bay. The bay currently stores capsules containing recent samples from SR-388 as well as parts of your suit infected by the X-parasites. The cause of the explosion is as yet unclear. Investigate. Move quickly and quietly... You are still unable to use most of your latent abilities. Don't forget that, Samus. Stop at the Navigation Room on the way. Uplink from there.



From the ship, go left through two doors until you reach a room with a series of yellow platforms. Jump back and forth, working your way to the top, and go through the door on the left to reach the Main Deck. Go through the next door and walk past the floating steps (for now, all of the hatches above you are locked) to the next door, which leads to the Navigation Room.

The Story of Samus



I'd been assigned to watch over Biologic's research team, so I once again found myself on the surface of SR-388. It was there that I was attacked by a life-form I had never encountered before. It was only later that I learned the identity of my attacker: the parasitic organism we now know as X. Unaware of my condition, I was returning to the station when disaster struck. Once the X had infested my central nervous system, I lost consciousness and my ship drifted into an asteroid belt.



The ship's emergency systems automatically ejected the escape pod before impact. Biologic's vessel recovered it and transported me to Galactic Federation HQ. However, during the journey, the X multiplied within me, corrupting large areas of my Power Suit.

It then came to light that the organic components of my Power Suit had become so integrated with my system that it could not be removed while I was unconscious. Large portions of my suit had to be surgically removed, dramatically altering my physical appearance. However, the X in my central nervous system were too embedded to be removed safely. I was given a minimal chance of survival. Then, someone found a cure. They proposed using a Metroid cell to make an anti-X vaccine. It seems that the Federation had managed to preserve a cell culture from the last infant Metroid from SR-388. The serum was prepared and injected without delay.



The X were immediately and completely destroyed. As for me, one life ended... yet I survived reborn as something different. Pondering this fact, I realize I owe the Metroid hatchling my life twice over.



NOTE

The Navigation Room is where Samus receives new information on her current objective. If you backtrack and revisit a Navigation Room, you'll be able to confirm the current objective.

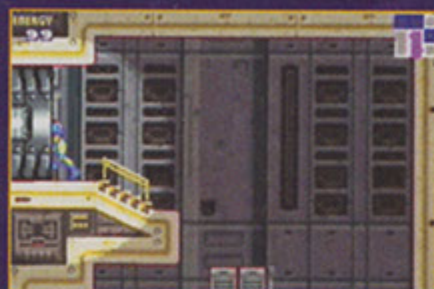

Continue to the left and climb the floating steps and stairways to reach the door on the upper left. Work your way to the bottom (the door on the upper left is impassable) and go through the door to reach the Quarantine Bay. Kill the infected creature, then retrace your steps to the Navigation Room for further instructions.



Exit the Navigation Room by going to the right, then climb the floating steps in the next room until you reach the white blinking hatch on the right. Push **Ⓢ** to open the hatch (this is the method for opening all hatches in *Metroid Fusion*). Kill the creature in the hallway, absorb the X-parasite, and continue through the next hatch to the Save Room.

**Objective**

This is unfortunate news...The specimens brought back by the field team were infected by X-parasites. The X can mimic its prey; any specimen could have hosted it. Before the explosion, a security sensor scanned one...The gelatinous X-parasites invade and rapidly reproduce, killing the host creature. They also absorb DNA and use it to mimic the host. You were almost killed by an X infection. Only the Metroid vaccine saved your life. It seems the Metroids were the main predators of the X. That's why the vaccine worked so quickly and so well. But it has also changed your cellular makeup. You will never be infected by X again...In fact, you can now absorb any free-floating X-parasites without a host by merely touching them. This will allow you to replenish health and restore weapons. You may also restore latent abilities this way, so pursue free X-parasites whenever you possibly can. This station is home to many species...some violent ones. We must keep the X out of breeding environments at all costs. This is vital, Samus. I am already detecting massive bio-signs in this region. The X are gathering. This may be our chance to exterminate them, but...You are only at 10% battle capacity. Your chance of survival is extremely low. The Federation needs you alive and on duty, Samus...Now, get going. I have released the lock on Level 0 hatches (white). Look for the blinking hatches.

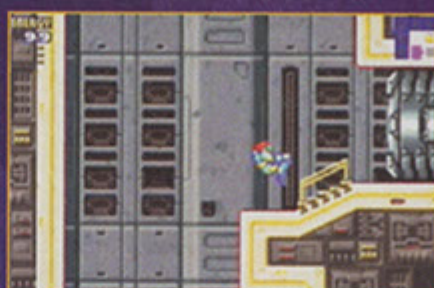

Exit the Save Room, continue to the right and kill the creatures, and then climb up the floating steps. You are not yet equipped to destroy the alien growth that blocks the white hatch on the right, so kill the creature on the step above you, continue up to the next hatch on the right, and enter the Navigation Room.

Objective

I have received news from HQ. They can support you with downloadable weapons data. Once you have this data, you'll be able to use Missiles. This will help against some enemies your beam can't hurt. Head to the Data Room for the download. With Missiles, your chance of survival climbs to 20%.



Exit the Navigation Room by going to the right, blast the creatures in the next room, and climb the steps to the white hatch on the right. Step on the elevator and take it up to the Operations Deck. Exit to the left,

go through the next passageway, and continue to the Recharge Room, where you can restore your energy to maximum capacity. Save your game in the next room, then retrace your steps past the Recharge Room.

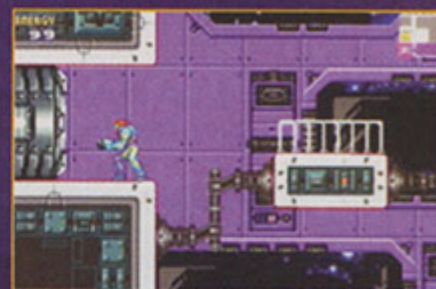
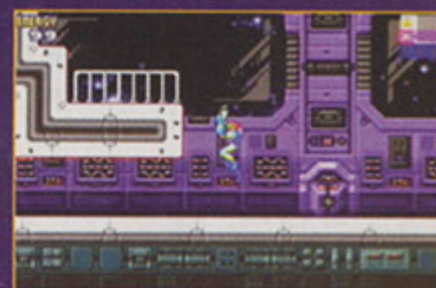

Climb the ledges on the left to the white hatch that leads to another Navigation Room. A brief message reminds you that the Data Room is just ahead.



Step onto the pad to activate the download. When it is finished, Samus gains Missile capability (Hold **R** and press **S**). Go back to the Navigation Room for new instructions.



Objective

Electrical interference has knocked out the elevators on the Main Deck. This may be related to the X. I'll work on it. As for you...Try to find another way to the target. I'm reading huge bio-signs, so I hope your Missiles work...To reload Missiles you can use a Recharge Room or absorb a special type of X-parasite. You'll see them. Try it out. Missiles are your only hope. Don't hesitate to use them. Now, find a way to the target.



Exit to the right and jump across two platforms. Use your missile to blast the hatch on the wall to the right, then leap across to the revealed opening. Proceed through the tunnel and blast the alien growth blocking your path (it takes three missiles to do the job).

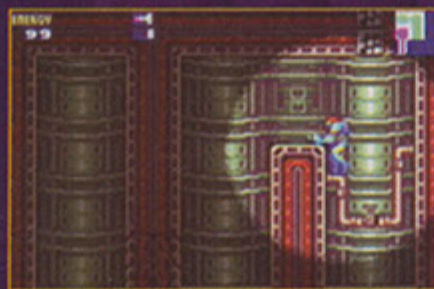

Follow the path over the pillar. Note the crumpled section of wall. Fire a missile to blast an opening, then walk through to the other side, where Samus drops down to the next level.

TIP

Look for similar sections of damaged wall to find openings on other levels of *Metroid Fusion*.

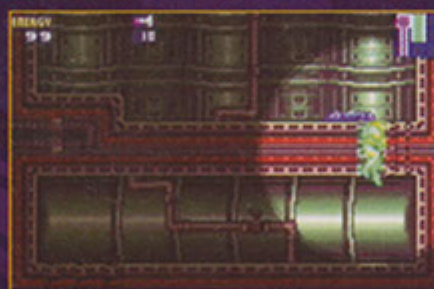
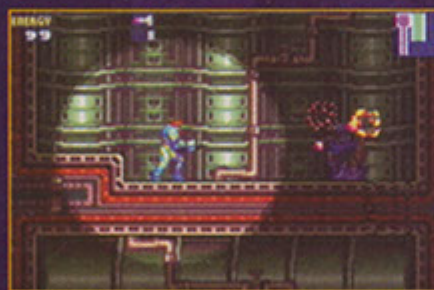

Kill the creature to the right and walk to the crumpled section of floor (similar to the damaged wall, this marks a weak area that gives way under Samus's weight). Walk back to the left to a similar floor tile and drop all the way down to the next level.

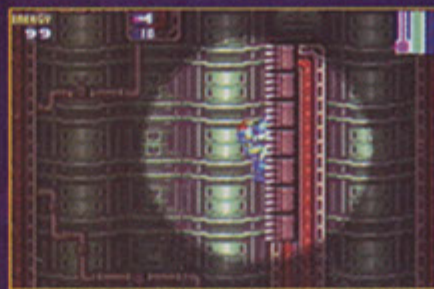

Climb the ladder and continue to follow the path down, and then up and over a pillar. A long drop through a tube leads to a Missile Tank, which increases Samus' missile capacity.

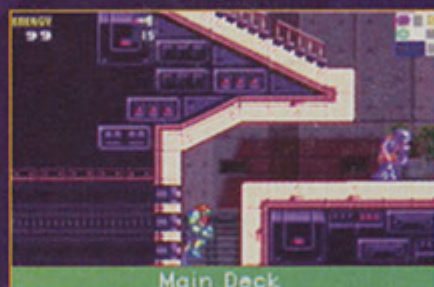

Proceed to the right and reenter the Main Deck. Blast your way past two creatures that continually reanimate as they absorb floating X. If you are low on energy, you can hang around here for as long as you want, absorbing X until Samus is back to maximum. When you are ready to advance, fire a missile at the giant eye (when it is open) to clear a path to the door.



Use back-flips to work your way up and over the ledge, and pick up another Energy Tank. Drop all the way down to a large chamber where you face Arachnus, a nasty monster that fires lethal energy blasts at Samus. If the blasts don't get you, the trail of fire will.

Making matters worse, the monster morphs into a spinning ball and plows into Samus. You must leap over the ball and immediately fire missiles at the Arachnus's back when it resumes its original form. This is when it is most vulnerable to penetrating fire.

After you destroy Arachnus, a Core-X remains. This is a circular shell containing a cluster of X. Continue firing missiles until you penetrate the shell and release the X (the Core-X damages Samus with every contact, so be careful). Grab the X before they float away. When you finally prevail, Samus regains Morph Ball ability. By pressing the + Control Pad down twice, Samus turns into a ball, which is useful for avoiding enemy fire or squeezing into narrow openings.

Sector 1 (SRX)

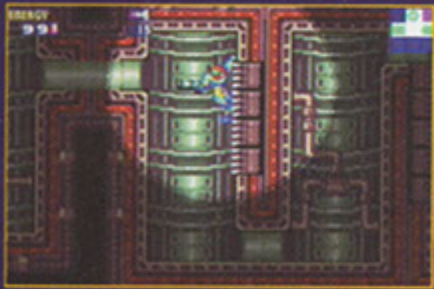
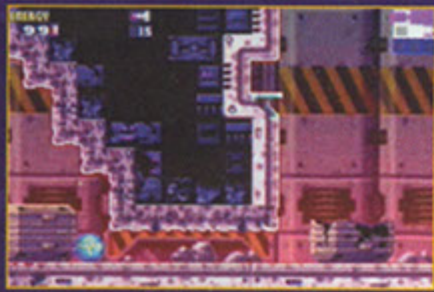

Morph into a ball and roll through the tunnel to the next section. Climb over the rock formation, then leap up to the opening. Hang on to the edge and press the + Control Pad up once to morph into a ball. Roll all the way through the tunnel into the next room, then use your new Morph Ball ability to navigate the narrow openings. When the tube appears to be blocked, hang on the ladder and blast the opening with an energy beam to clear the way.

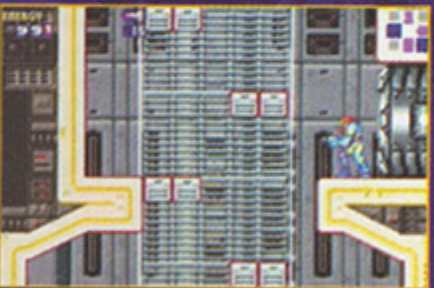
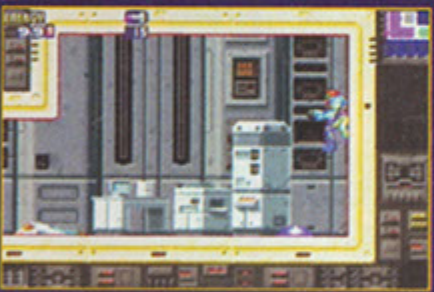

When you reach the yellow wall, stand up and walk behind the wall and into the next room. Continue to the left, stopping to save your game. (You wouldn't want to face Arachnus again, would you?) When you reach the room with floating platforms, drop down to the lowest level and walk through the doors to enter the Navigation Room. Congratulations! You just completed the Main Deck level, but there is little time for celebration. Another objective is on the way.

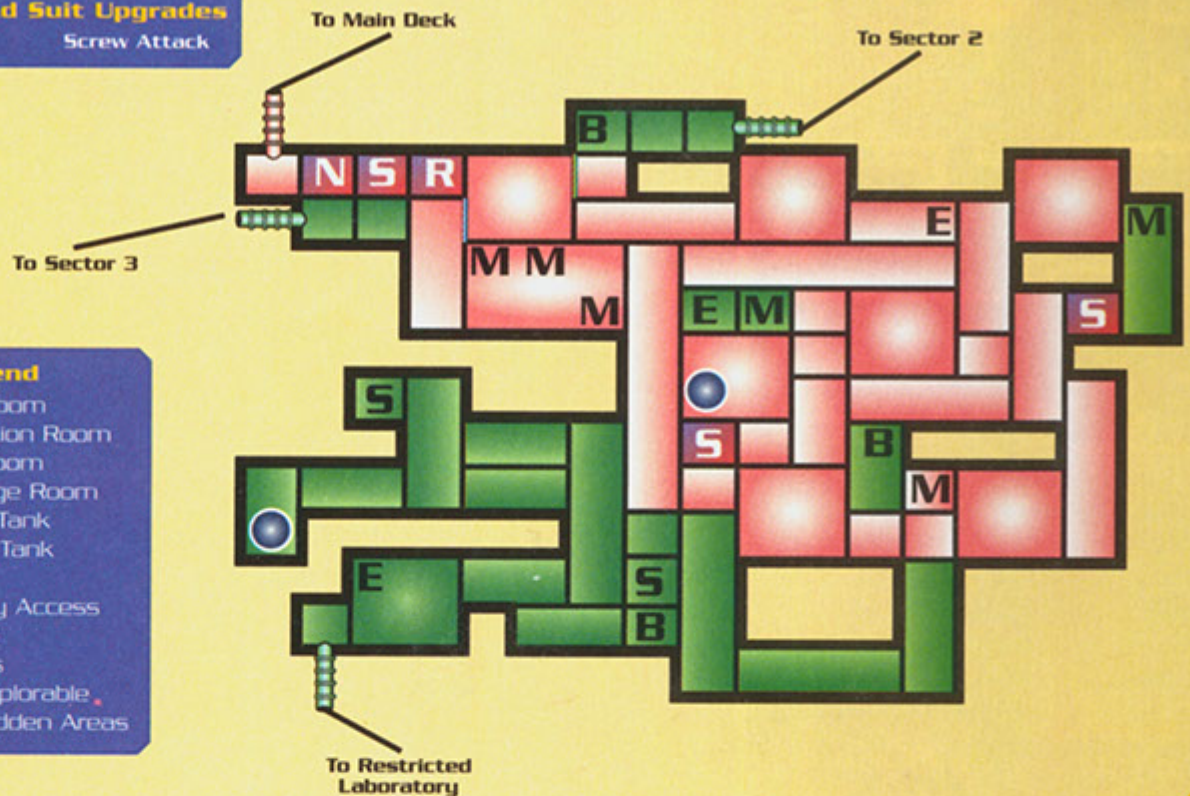
Weapon and Suit Upgrades
 Charge Beam Screw Attack
**Legend**

- S** - Save Room
- N** - Navigation Room
- D** - Data Room
- R** - Recharge Room
- M** - Missile Tank
- E** - Energy Tank
- B** - Bombs
- X** - Security Access
- O** - Bosses
- L** - Ladders
- Red** - Explorable
- Green** - Hidden Areas

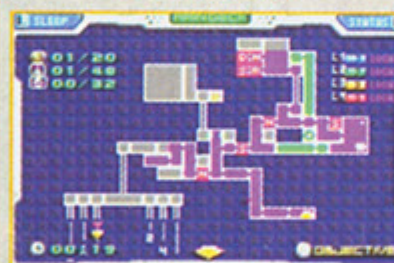
Objective

Samus, it's as I feared. The breeding environments have been invaded by X-parasites. Sector 1 (SRX) shows several abnormalities on bio-sensors. Sector 1 is a simulation of the SR-388 ecosystem. To get there, take the Main Elevator to the access shaft and use Elevator 1. Use the Navigation Room just inside for further briefing. I'm not sure, but I think that whoever allowed the X into the environment may also be linked to the earlier explosion.



Exit the Navigation Room by going to the left and work your way up to the door in the top-left corner of the next room. Morph into a ball and slip through the opening into the next room. Continue through the pink hallway and take the main elevator down to Sector 1. As Samus descends, you hear an explosion and see an ominous figure approach from the left. It looks like Samus, but somehow,

very different. After looking around, the invader launches another missile, destroying the door on the left and effectively sealing off the platform. When you arrive at Sector 1, continue to the Navigation Room for further instructions.

Objective

The Main Elevator leading to the access shaft has been severely damaged. It will be totally unusable for some time, unfortunately. Some unknown agent is at work. Something very powerful...certainly not human. I'll report when I know more. Now, listen closely. The X in Sector 1 have invaded the atmospheric stabilizers. They must want to alter the environment to their needs. They are already reproducing. Clear all 5 atmospheric stabilizers to stop them.

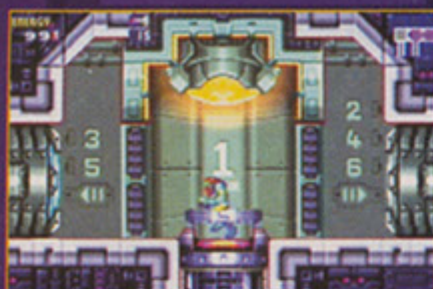

Exit to the right, pass through the Save Room and Recharge Room, and then work your way down to the floor of the next room. Exit through the right-hand door and get ready for a surprise attack from X-clusters. You must jump around and avoid their attacks as you find a good position from which to attack. Each destroyed cluster releases two or three X, so be ready to grab them before they float away.

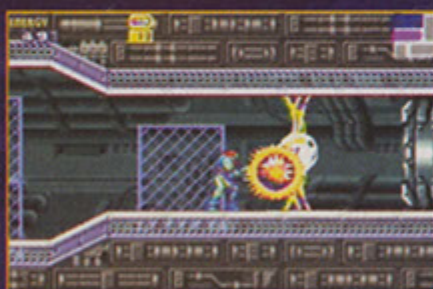

Continue to the right, blast your way through the alien growth, and walk through the white hatch to reach the first atmospheric stabilizer. Each unit is installed inside a floating box that is enclosed on three sides. You must position Samus so she can fire missiles at the open side. Don't waste your ammunition by firing at the closed sides; they cannot be penetrated. Make your way up and over the rock shelf until you reach a small platform to the right of the atmospheric stabilizer. When the unit comes into view, fire missiles to restore it to working order. Continue through the door to the left to find the next stabilizer.



Get ready for a vigorous attack in the next room from a group of bouncing monsters. Wait until the group hops in the opposite direction, then jump down and drop into a crouch. Fire rapidly to clear the room quickly, and don't forget to sweep up the freed X. The next two enemies are in the air, and you'll need missiles to take them out. Fire at an angle to destroy them while they hover. If you wait until they start flying and bouncing around the room, your task will be much more difficult.

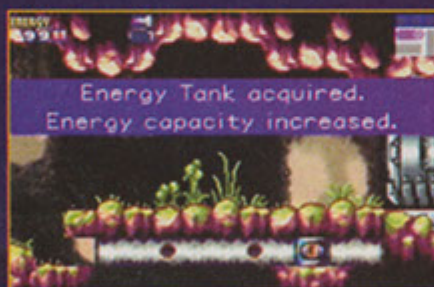

An Energy Tank power-up is tucked away underground at the end of a tunnel. Kneel down and blast away the wall to gain access, then morph into a ball to reach the tank.



Continue out the door, hop down one level, and exit through the white hatch on the left side. Inside the cave you meet a new enemy, a cute little Mousin. It is impervious to frontal attacks, so you must leap over it and shoot quickly before it turns around. Take care of two Mousins, then continue out through the hatch to the left.



Drop all the way down to the bottom and through a gauntlet of clawed creatures that are elusive and powerful. You can engage them if you like, but you are better off moving quickly to the lower level and out the door on the right. Get past a submerged Sciser and enter the next room, where you find another atmospheric stabilizer.



Hop up to the ceiling and climb hand-over-hand until the atmospheric stabilizer comes into view. The open side is on the right, so you must carefully hop from platform to platform until you reach the ladder on the far right. Climb to the level of the stabilizer and fire a couple of missiles to clear out the X. Three more to go.



Climb down to the floor and continue out the door to the right, past another pesky Mousin. Exit through the door and jump across to the white hatch on the other side. Once inside the cave, somersault back and forth between the shelves to reach the top, then work your way across the ceiling to find the third atmospheric stabilizer.



Climb back across the ceiling rungs and drop down to the rock pillar. Somersault to the left and go through the hatch to a small cave that contains a Missile Tank. Shoot the Sciser on the far wall, grab the tank, and then return to the previous cave.

TIP

This is a good time to save your game. Three vertical shafts are on the right side of the Sector 1 map. A Save Room is attached to the top-right corner of the middle shaft. The next two atmospheric stabilizers can be tough, and if you save the game now, you can avoid having to go all the way back to the beginning.



Return to the wide vertical shaft containing the Space Pirates. Now, you must engage them as you work your way to the upper hatch on the right side. Walk into the cave, kneel, and blast an opening in the rock pillar to the right.



Climb the stairs on the right, then move back to the left until you reach an area above and to the right of the door. Look up and blast an opening in the rock shelf above. Swing up to the next level and walk to the right until you see the atmospheric stabilizer above. Wait until it is centered above Samus, then blast it with missiles.

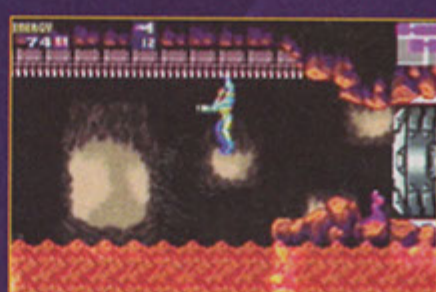

Return to the main shaft, deal with the Space Pirates that respawned during your absence, and hop across to the hatch on the upper left. Inside, you find a fiery cave that contains a valuable Missile Tank power-up. Grab onto the ceiling and move carefully across the lava (don't drop, or Samus will fry and die). When you are above the Missile Tank, drop down and collect it, then retrace your path out of the cave.



Using the long vertical shaft at the left center of the map, work your way down to the right and then up the vertical shaft in the lower-right corner of the map. Go through the hatch at the top left to reach a chamber with a closed door blocking your path. Shoot the bulb on the ceiling to raise the shutter. Go through the hatch to another cave.

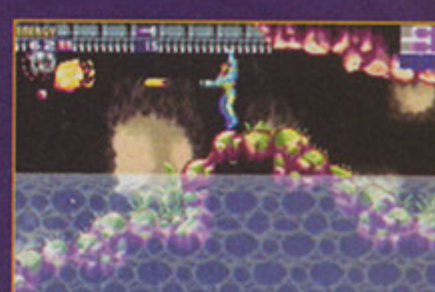

Grab onto the ceiling rungs and make your way across, but prepare to shoot two Scisers directly ahead of Samus. If they knock you into the water, you'll need to fight more Scisers, so try to clear the path as you stay on the ceiling. Continue to the end of the rungs and blast one more Sciser that guards the wall. When the area is clear, shoot a hole in the rock wall ahead to reveal a new path.

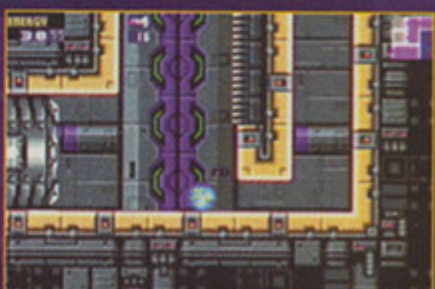
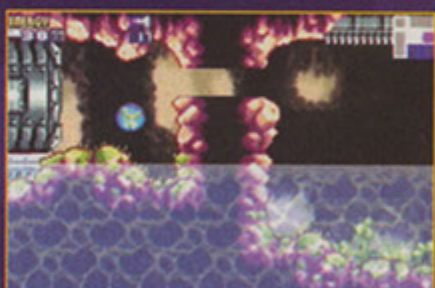

Morph into a ball, roll through the opening, and continue through the hatch into the next room. Step off the ledge and drop through the breakable tiles to the bottom. Morph into a ball again to slip under the wall into the next chamber.

TIP



The next hatch leads to a short passageway and then to a Save Room. By now, you're probably running low on energy and missiles. Stay in this room and harvest precious X by killing the slow-moving creatures. They keep reanimating, so stay here as long as it takes to bring your resources back to maximum levels for the upcoming boss battle. Save your game, then return to the chamber.



Continue to the left until you see a large glass tank containing a Chozo Statue holding a Core-X. Shoot the tank to release the Core-X, then get ready to run and shoot. If you can, grab the X released when you destroyed the tank. Then concentrate on shooting missiles at the Core-X as it flies around trying to get you. Each time you score a hit, more X are released. Scoop them up if you can, but stay focused on the Core-X or it will finish you.

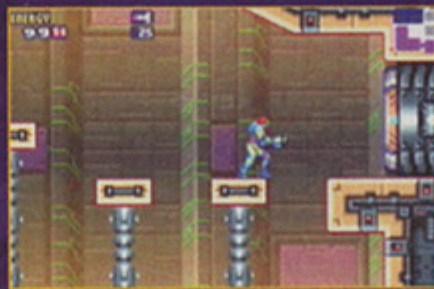
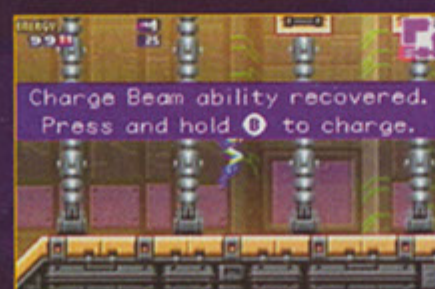
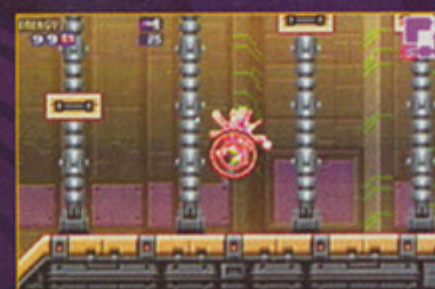

When you destroy the Core-X's outer shell, a red blob of X remains. Snatch this out of the air to regain Samus's lost Charge Beam ability. Climb the steps and exit through the hatch in the upper-right corner of the room.

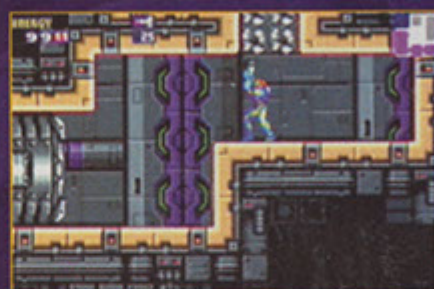

Climb up to the ledge in the next room and shoot the tiles directly above to open a path. Jump up and exit to the right into one last cave. Now you must fight your way through more creatures to reach the last atmospheric stabilizer. Move to the extreme right side of the cave, drop down, and morph into a ball to return to the left side. Climb up the rocks to reach a point that is next to the stabilizer. Shoot through the rock pillar to clear a line of sight to the stabilizer, then blast it. With all atmospheric stabilizers online, the air is quickly cleared. Now you must survive as you work your way back to the Navigation Room at the top-left corner of the map.

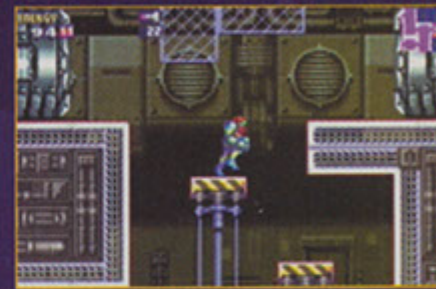
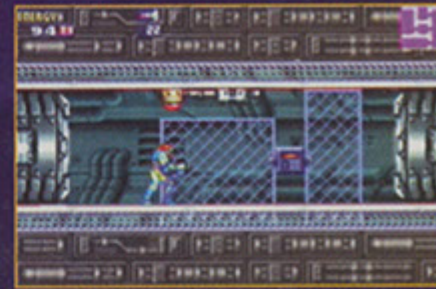

Exit through the hatch in the lower right-hand corner of the room, and shoot the bulb in the next chamber to clear a path to the next hatch. Climb the steps to the top and exit through the left-hand hatch. Follow the path all the way back to the Navigation Room to finish the level.

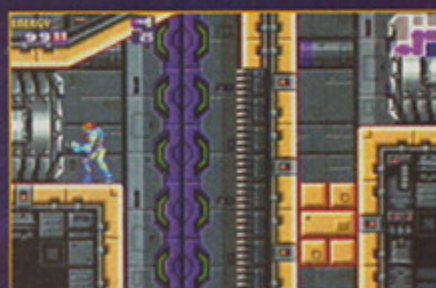
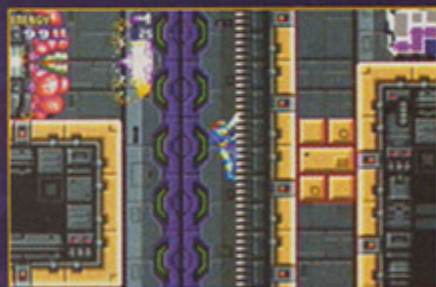

Climb up the ladder until you are across from the giant eye. Unlike the previous one, this eye shoots back. If the eye is clear white when the lids open, get out of the way, because an energy blast is coming. Continue moving up and down until the open lids reveal a dark eye in the center. While the eye is open, quickly fire a missile to destroy it. Hop across and go through the hatch.



Sector 2 (TRO)

Weapon and Suit Upgrades

Bombs
Plasma Beam
High-Jump

Legend

- S - Save Room
- N - Navigation Room
- D - Data Room
- R - Recharge Room
- M - Missile Tank
- E - Energy Tank
- B - Bombs
- X - Security Access
- - Bosses
- Ladders
- Red - Explorable
- Green - Hidden Areas

To Main Deck

To Sector 1

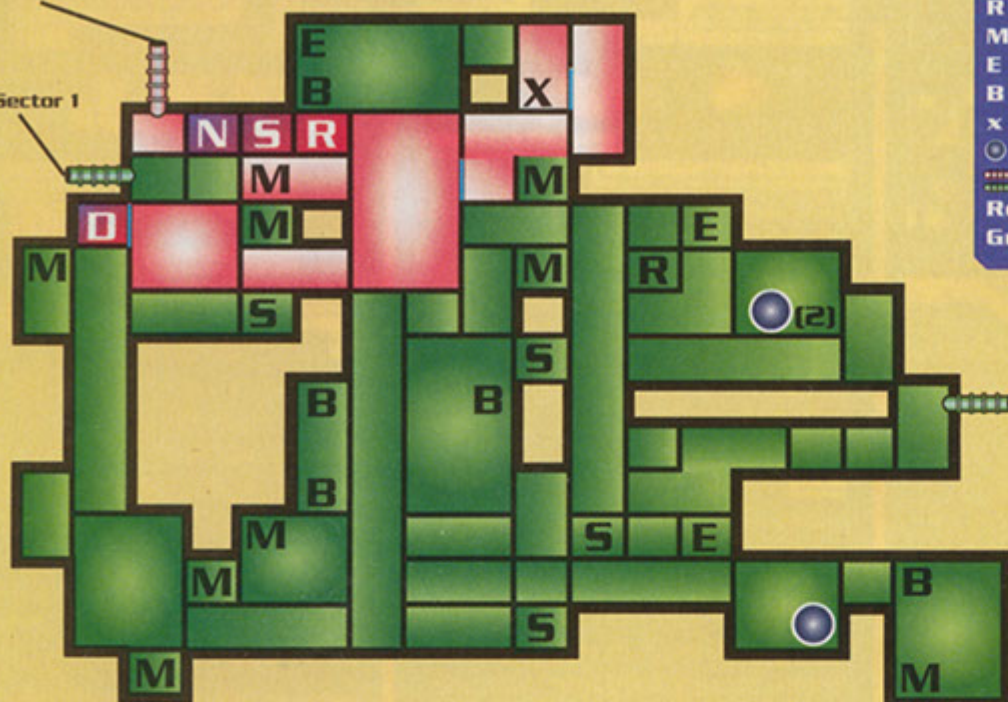

To Reactor Silo

To Main Deck



Proceed through the first of two jungle rooms, and continue moving to the right until you reach the second room. You'll encounter more red Zeros, but they don't put up much of a fight. Climb the ledges to the top and exit through the white hatch on the left to enter the Security Room.

Objective

I have learned the identity of our mystery saboteur... Samus, it's an X mimicking you. I have named it the SA-X. I believe the SA-X came from the capsule containing your infected suit parts. It used a Power Bomb to escape the Quarantine Bay. That explosion breached the capsules containing all the X that started this disaster. But the SA-X is definitely our biggest worry right now. The SA-X is mimicking you at full power. You can't face it. If you see the SA-X, just run. Don't think about fighting.... You are still very vulnerable to cold, an unexpected side-effect of the Metroid vaccine. Like Metroids, you can be frozen by an Ice Beam. Of course, the SA-X is armed with the Ice Beam. Stay away. If you see it, just run. HQ says they have Bomb data ready in the Data Room. Bombs will help you find a way out if the SA-X traps you. The Data Room is here, but...it's sealed by a Level 1 hatch. You'll have to find the Security Room and release the Level 1 locks. But per safety protocols, it's not marked on the map. You'll have to find it on your own somehow, Samus. So, first find the Security Room and unlock Level 1 hatches, then go to the Data Room and get that Bomb data.

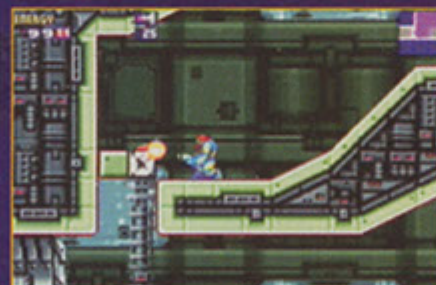

After arriving in Sector 2, walk through the Save and Recharge Rooms until you enter a green aquarium room. Shoot the fat red Zeros slithering up and down walls, and continue down past the white hatch on the left until you reach a green tile blocking your way. Kneel and shoot the tile to clear the path.



When you reach the bottom, continue to the right and climb up the ledges, shooting red Zeros as you go. Climb all the way to the top and exit through the white hatch on the right.



Drop down and stand on the pressure pad to unlock the blue hatches. Exit through the blue hatch on your right to reenter the jungle room. Climb down to the bottom and exit through the hatch on the left.



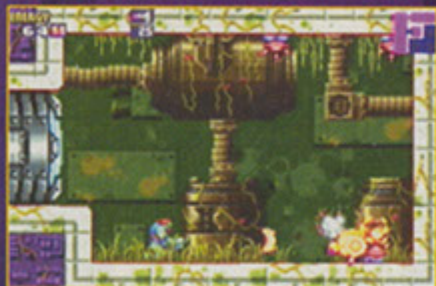
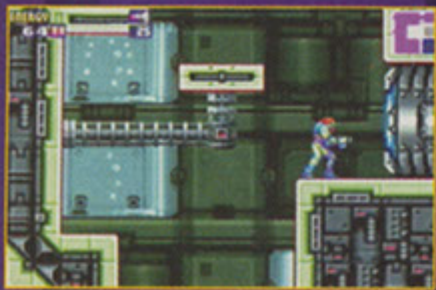

Pass through the first jungle room and return to the aquarium. Drop one level and exit through the newly unlocked blue hatch on the right. This small jungle room is a great place to harvest X when Samus's resources are low. The slow-moving Owtsch travel around the perimeter of the room, and you can shoot them at will to release a steady stream of X. When the room is empty, simply exit and return for a fresh crop.



Return to the aquarium room and drop all the way down to the bottom. Clear the Zeros as you go, and exit at the lower left-hand corner of the room. Go through the next room and get ready for a new enemy as you exit to the left. Along with the Zeros, you encounter a Dessgeega that chases Samus around the room. Knock it out of the air, then climb the ledges to exit the room through the blue hatch on the right to enter the Data Room.



Step onto the pressure pad to activate the download, which gives Samus the ability to set off an unlimited number of bombs when morphed into a ball.

TIP

Regaining the Bomb ability is critical, because it allows you to quickly explore floors or corner walls for hidden passages. To make sure you don't miss anything, simply spread bombs across the full length of a room to see what is revealed. Don't worry about damaging Samus; she is bombproof, even when sitting on top of the bomb when it blows.

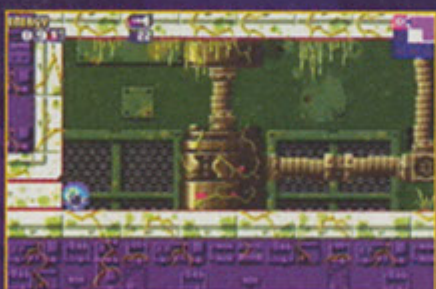

Exit the Data Room the way you came, morph into a ball, and roll Samus to the left-hand corner of the room. When the bomb explodes, a tube and

tunnel are revealed. Drop down and roll to the right to reach a lower level and two new hatches, one on either side.



Clear the area of the Dessgeega, then exit through the right-hand hatch to reach a Save Room. Store your game data and then go back to the room next to the Data Room (where you first revealed the tunnel). Climb up to the narrow ledge on the right and set off a bomb to reveal an opening to the right (note the red outline on the tiles; this often indicates a breakable area).



Explode two more tiles to gain access to a hidden room containing a Missile Tank power-up.

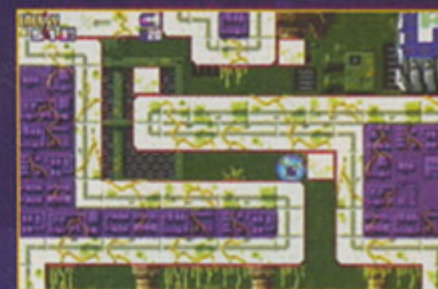

Return to the room in the lower left-hand corner of the map. Morph into a ball and roll up to the tile that appears to block Samus's path. Set a bomb to blow Samus up and over the tile. Blow up the next tile in the tunnel, then drop down to the next room.



Blast the Zeros, then set another bomb by the tile outlined in red. Wait until the Zeros walk the other way, then drop to another tunnel. Roll to the opening, move to a crouching position, and shoot the Zeros before they return.



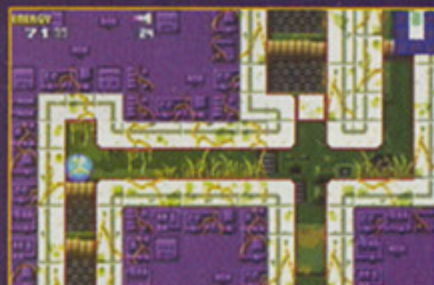
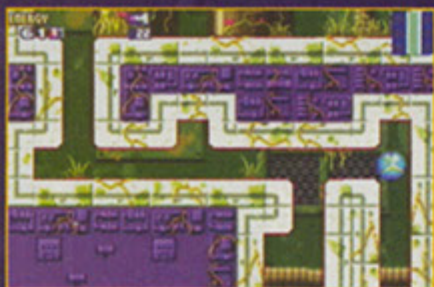

Continue rolling to the left, and set a bomb at the second tile (the first one won't budge). Drop down and work your way to the right, blowing up tiles and worms as you go.



One more bomb takes you all the way down to another hatch. In the next room, drop down to the lowest level and exit through the hatch to the right.



You're back in the jungle, with plenty of red Zeros and Dessgeega to make your life miserable. Use a bomb to blow up the short ledge to the right, allowing you to drop down.



A new, more dangerous enemy appears: a rocket-powered Side Hopper that can only be destroyed by missiles or charged-up beams. Shoot it, drop down, and exit to the right.

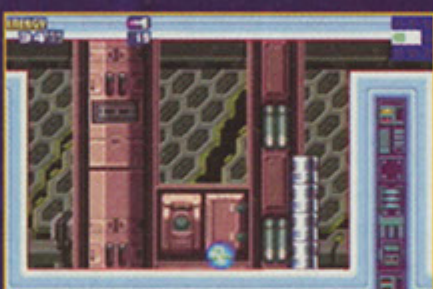

Move to the right, climbing up and over the obstacle. Shoot the newly infected Puyos and keep moving to the right. Samus appears to be trapped between the two obstacles, but thanks to morph bombs, there is a way out. Place a few bombs near the obstacle on the right to create a pillar. Use it to climb over the obstacle.

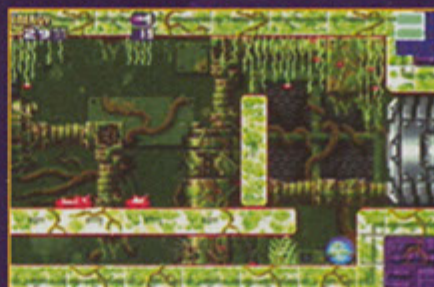

Take care of the Puyos and exit through the hatch on the right. Continue moving to the right into the next room, then use a morph bomb to clear an underground path to the next hatch. If your energy is low, turn around, use a bomb to blow a hole through the green pillar, and quickly shoot the Puyos to collect a nice resource boost.

TIP

Save the game in the room to the right, and if your resources are low, repeat the process described above to stockpile energy and missiles. Don't forget to save your game when Samus's resources are maxed out.



Continue left to the next room and climb the ledges up and over a tall pillar to reach the white hatch on the right. Harvest the plentiful Zeros on the ceiling, then continue through the white hatch on the right.



Go across to the other side and up to the alcove on the left. Plant a couple of bombs on the ledge and note the blocks that appear. They have Power Bomb symbols, which means that your regular bombs cannot destroy them. Later, when Samus gains Power Bomb ability, you'll be able to access this passage.

For now, drop down to the hatch on the right to reach a Save Room. On the other side, you find another good resource area stocked with Owtych that are eager to sacrifice their existence for the sake of X. Like the room described earlier, you can repeatedly leave and enter to gather more resources.



Exit to the right to collect an Energy Tank power-up, then drop to the lower ledge and place a few bombs to reveal a new path.



Drop down to confront another giant eye. Like before, you must wait until the eye opens, and if it has a black area in the center, fire away with missiles. When the eye is gone, proceed through the door to meet your new boss.



A large Core-X becomes a giant plant that would like to eat Samus for breakfast. It bounces up and down very quickly, and you must run back and forth to avoid being trapped. However, after several bounces, it pauses in the air, then floats slowly down. This is your chance to fire missiles straight up into the plant. When you score a hit, the plant changes colors and looks visibly upset. After a few hits, it begins to shrink. After you whittle it down to size, a final hit turns the plant back into a Core-X. Continue firing until you penetrate

its shell and release the X (each hit releases a few X, so be ready to jump up and grab them for an energy boost).

TIP

When the Core-X turns red, it is one shot away from being destroyed.



After blasting the Core-X, leap up and grab the remaining red X to regain Samus's Hi-Jump and Jumpball abilities. You can now leap higher, which is especially helpful in morph-ball form. By sending the ball into the air, you can place bombs at various heights, revealing hidden passageways or special breakaway blocks.



Exit the room by going to the left, jump up, and go through the hatch on the left. Continue to the left, stopping to save your game, then walk through the green room and stop to the right of a destroyed door. Place bombs on the ground to reveal an opening to the lower level.

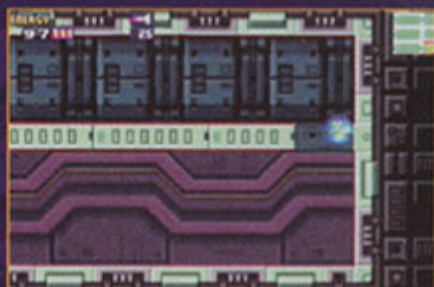

After dropping down, you catch a glimpse of what looks to be an enemy agent that roams the corridors. After it walks through the door to the left, place bombs on the far right section of floor and drop to the next level. Exit to the left, then drop one level and go through the hatch on the left.



Leap up to the ceiling rungs and make your way across the room. Collect the Missile Tank at the end of the room, then drop into the water. Watch out for the Skultera as you place a bomb in front of the palm tree. Use the pillar that rumbles up out of the ground, and scale the green obstacle to the left. Exit through the hatch to another underwater room.



Now comes the tricky part. Plant a bomb to the left of the palm tree to grow another pillar. Climb up to the top, inch your way to the extreme left edge (it will look like Samus is off the pillar), then morph into a ball. Jump up, and while airborne, direct the ball to the left. As you do this, place a bomb when the ball is close to the block outlined in red. This will take a little practice, because the ball must be close to the block for the bomb to do its job. Climb through the opening to grab the Missile Tank on the other side. Retrace your steps and leave the water room.

TIP

The Skultera attack ferociously as you move through the water tank on the right. If you are low on missiles, morph into a ball and roll to the left. When the Skultera follow you, roll back to the right and quickly climb out of the water. The Skultera do not attack when Samus is morphed.





Back in the green room, jump up onto the shell attached to the wall on the left. Keep climbing up, using bombs to remove blocks from your path (high jump to send the ball up to the level of the last block, where you can place a bomb). Exit through the hatch at the top right.

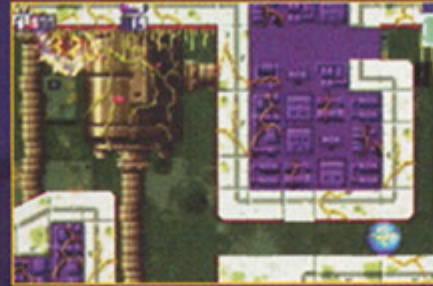

Go quickly through a short passageway to reach another green room. Climb up to the short ledge on the right and place a bomb in the alcove to reveal a new path. Roll into the room to pick up a Missile Tank. Jump up to the opening on the upper left and roll into the purple wall. Use one more bomb to access the next room.



Jump down and roll through the opening to the left, taking you up to a green block. Use a bomb to clear the way. Step on the wall shells to reach the blue hatch on the right. After clearing the room, morph into a ball and jump up alongside the right-hand wall, leaving a bomb halfway up. The explosion reveals an opening to the next room.



Pick up the Missile Tank, then retrace your steps to the green room. Climb to the ledge on the left, near the computer monitor, and place a bomb to open the wall. Climb up the ledge to the left and exit through the hatch to reach the Recharge Room. Save the game in the next room, then proceed to the Navigation Room for your new objective.

Sector 4 (AQA)

Weapon and Suit Upgrades

Speed Boost

Diffusion Miss.

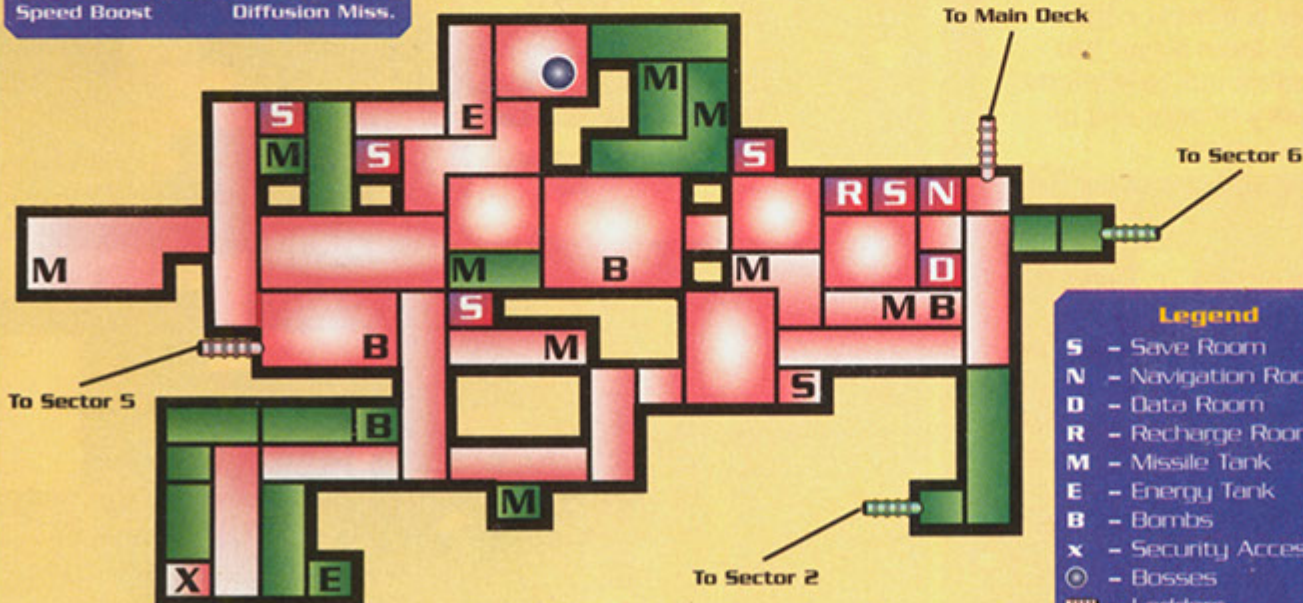

Legend

- S** - Save Room
- N** - Navigation Room
- D** - Data Room
- R** - Recharge Room
- M** - Missile Tank
- E** - Energy Tank
- B** - Bombs
- X** - Security Access
- - Bosses
- ▬ - Ladders
- Red** - Explorable
- Green** - Hidden Areas

Objective

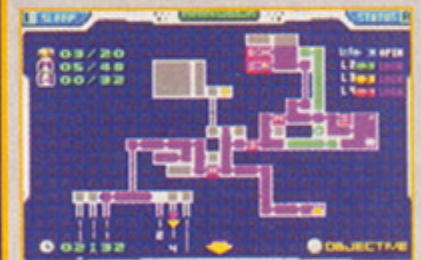

Samus, we've got trouble. Releasing the security lock may have been a bad idea. The SA-X has invaded the water environment in Sector 4 (AQA) with several thousand X. With the blue hatches active, the SA-X slipped in easily. The creatures and systems in Sector 4 are already showing multiple irregularities. I'm currently investigating. I'll brief you in the Navigation Room when you arrive. Now, head for Sector 4.

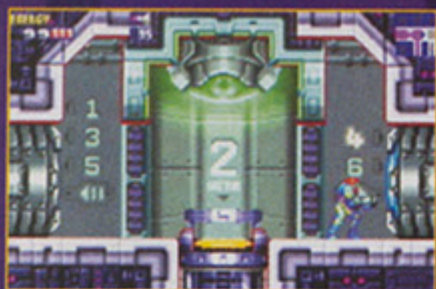

Follow the signs and take the elevator down to Sector 4. Go left to reach the Navigation Room.

Objective

This sector has taken more damage than expected....I knew the X were powerful and destructive, but still...this seems to be purposeful. We certainly can't rule out the possibility that the SA-X has a high degree of intelligence. I find the X fascinating, especially this SA-X...but I digress. This sector is home to a very large creature the researchers call Serris. It is capable of moving and attacking at ultra-high speed. The more senseless and widespread destruction here may be attributable to Serris. No doubt the SA-X released it, but I can't be sure why yet. Serris has returned often to the breeding tank here. Its natural behavior must be to go back to it periodically. It's a valuable specimen, but you have been authorized to terminate it. If you don't, it may invade other sectors. While you're moving, be careful. Some broken power nodes have electrified the water...but we can't cut the power. Doing so would affect the whole station adversely. If you touch the water, you'll be electrocuted. Conserve energy as you go.

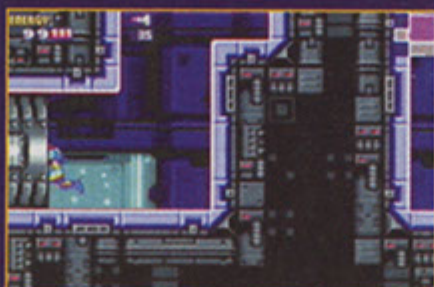

Exit to the left, go through the Save Room, and enter the blue room. Work your way to the left, over the obstacle and down to the hatch on the lower left. Run through the short passage to reach the next hatch, which opens into the aquarium room.

CAUTION

In the following section, Samus is hanging above electrified water. If you must jump down, or if she is knocked down, look for the pairs of chains. If Samus falls near the chains, you'll be able to land on, or grab onto, one of the hanging platforms. Landing in the water is almost certain death. Even if you can scramble out to dry land, Samus's energy will be almost gone.



Climb to the top-right corner and place a bomb next to the large block positioned just below the ceiling. Grab the rungs and shimmy across the ceiling, but watch out for the Scisers coming at you and the ones shooting from below. Work your way to the left, shooting the Scisers before you jump to the next platform.

TIP

To shoot a Sciser that is above Samus, jump up, then fire as she comes down past the level of the target.

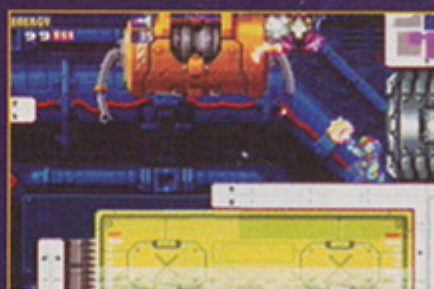
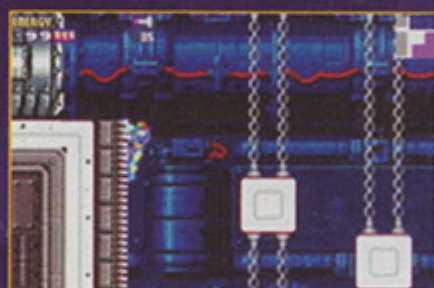

When you reach the end of the hanging platforms, jump to the ladder on the left, but be careful; there is only electrified water below. Go through the hatch into another aquarium room, where you face Scisers above and Skultera in the water.



Hop across to the second tank and jump in the water. Either shoot or avoid the Skultera as you make your way to the hatch on the left. Bigger Skultera are in the second tank, so shoot them before climbing up the ladder on the left. Jump up to the hatch on the left and enter the Save Room.



After saving your game, go back to the right, negotiating a series of shallow tanks. Shoot the Sciser to clear a path to the ladder. Hop back and forth between the short ladders above, then swing up and over the barrier to reach the next hatch.



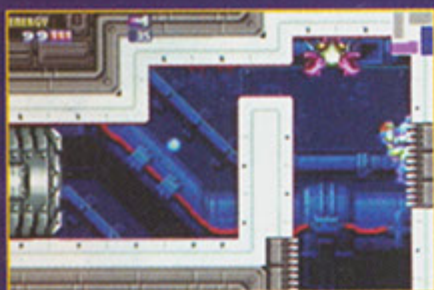

Collect the Energy Tank, then return to the two tanks. This time, drop down between the tanks, follow the path to the left, and walk through the hatch to the next room.



Shoot the Sciser overhead, then blast a hole in the ceiling. Climb up, morph into a ball, and place a bomb to remove the remaining blocks and open a path to the ceiling rungs.

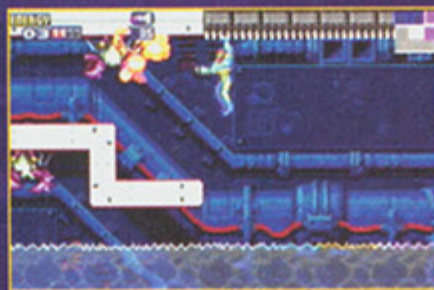

Travel across the ceiling, but be sure to shoot the crab before it knocks Samus into the electrified water below. Jump up through the opening in the ceiling and continue along the path to the ladder.

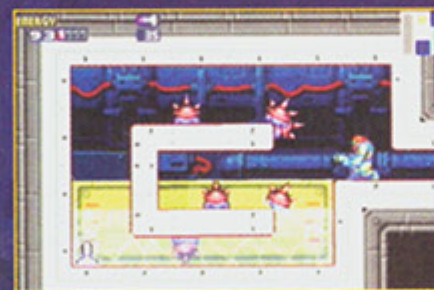
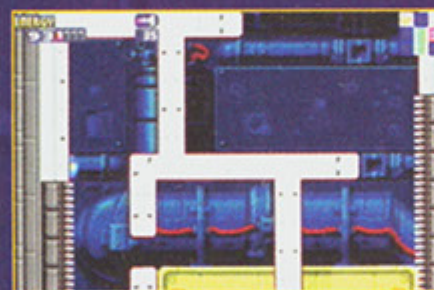

Climb up the ladder and morph into a ball just as Samus reaches the top. A hidden tunnel just above the ladder leads to a Missile Tank upgrade. Harvest the Owtch, grab the upgrade, and return through the tunnel to the previous room.

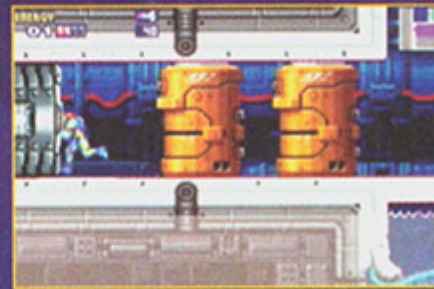

Go down the ladder and back through the opening in the ceiling. After you land, morph into a ball and place a bomb next to the wall to clear an opening to the left. Continue to the left and go through the hatch.

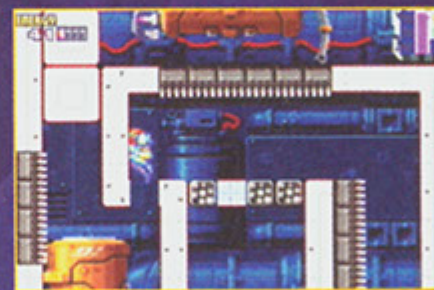
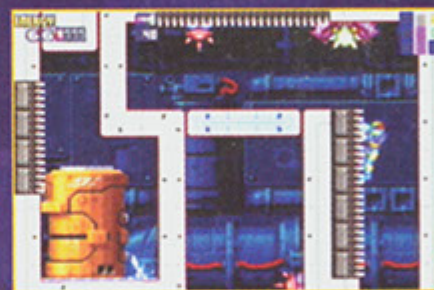

The Pump Control Unit is through the next hatch to the left, but you cannot reach the controls from here. Shoot a hole in the ceiling and jump up to reach the ladder. Shimmy across the ceiling rungs to the upper left-hand corner of the room and shoot a hole in the ceiling. Work your way around to the right and climb the ladder. Place a bomb in the left-hand corner to create an opening, then drop down.

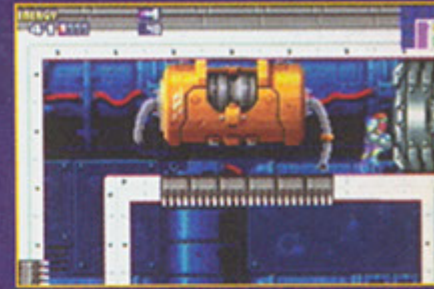
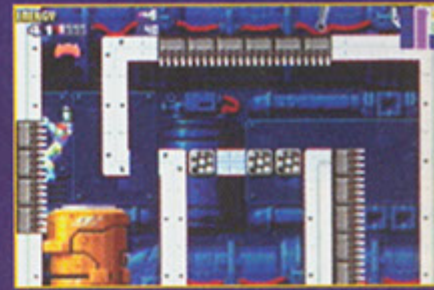

Climb the short ladder and shoot through the ceiling. Somersault back and forth to reach the top, and continue through the hatch to enter a Save Room. It has been a long, complicated journey to get to this point, so don't forget to save.

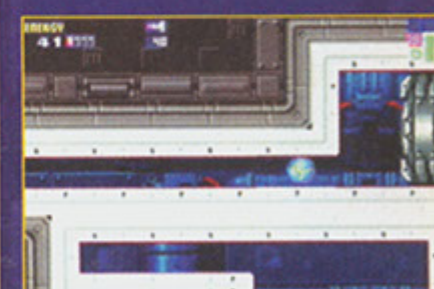

Before you leave the Save Room, note the crumpled section of wall in the lower right-hand corner. Morph into a ball and jump up to the broken wall to leave a bomb. After the explosion, jump up to the tunnel and roll to the right, exploding a path to the hatch.

the eye disappears, grab the red X that is released. This will give you maximum energy and missiles for the upcoming battle.

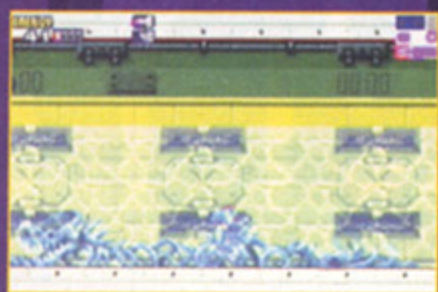

Go through the hatch to enter a room with a water tank containing a large skeleton. Jump into the water and walk to the right, climb out of the tank, and go through the hatch.

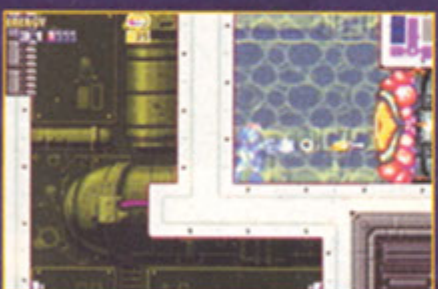
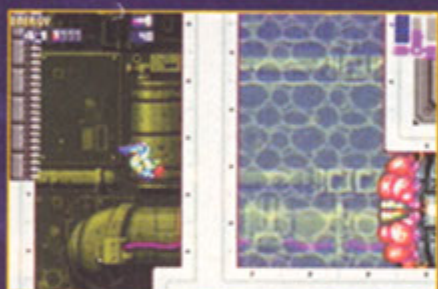

Jump up to the chunk of metal above the hatch, then continue up the ladder and into the tank to the right. You must get past another giant eye to gain access to the next room, where you'll face Serris. Unlike previous battles with the eye, this fight is in close quarters, with nowhere to run. Get ready to fire as soon as you see the dark spot. After



Go through the hatch, jump up to the ladder, and walk across the tiles that stretch across the tank. As you near the end, the tiles begin to crumble. Leap across to the right and take a position on the top rung of the ladder. Although you may be knocked off this spot during the fight, you must return here immediately, because it is the only vantage point for landing accurate hits on Serris.



The giant snake zooms back and forth and up and down as it scrapes against the ladder. You must use charged-up energy beams (missiles won't work), so keep your finger on **○** at all times. This way, you can release a maximum beam when Serris comes into range. *The only hits that cause damage are head*

shots. The easiest shot is when Serris is moving toward Samus, but you can also connect when the snake is moving away (as pictured). When you score a hit, the snake turns white and accelerates to super speed. Don't waste your time shooting until Serris slows down.

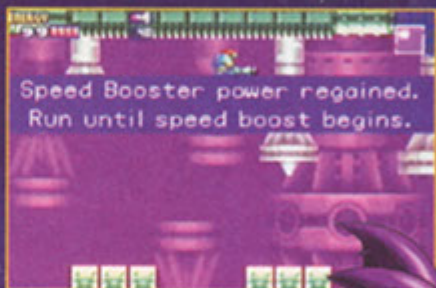

When the snake finally explodes, a Core-X remains. It is difficult to stay on the ladder when fighting the Core-X, but you can still shoot effectively from the tank. Keep moving to avoid the Core-X, and simultaneously pump it full of missiles. When you destroy the Core-X, only the pure X remains. Jump up to the tiles and leap up to capture it, giving Samus a new Speed Booster ability.

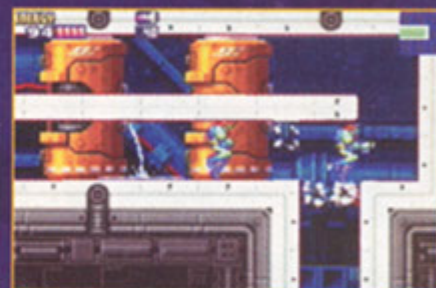
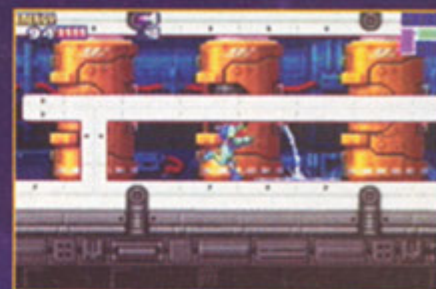

After killing Serris, exit through the hatch at the top right and walk to the far right of the next room. Place a bomb at the top of the vertical shaft to reveal the breakaway symbols. Clear the creatures as you walk to the far left, under the floor. Start running, and when the Speed Booster kicks in, the blocks crumble, dropping Samus down the shaft. Another pair of breakaway blocks give way, and Samus reaches the hatch.

NOTE

You will put this new ability to use immediately, so it is important to know how to use it. Speed Booster kicks in automatically after Samus runs for a certain distance without obstruction. When the boost engages, Samus runs at lightning speed, and is then able to smash through blocks or walls that are designated with the breakaway symbol (a sideways "V"). These symbols are hidden until a bomb explodes in the vicinity. The direction of the "V" is not important. It simply marks the location of the breakaway object. You may be able to hit it from either direction. The key is to be able to run freely, without stopping, until the Speed Booster takes over.



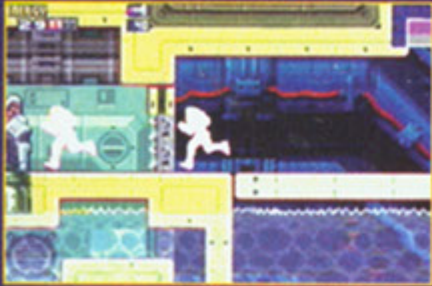
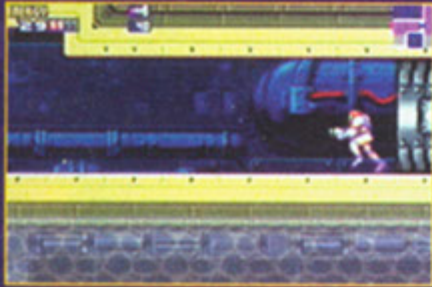

Go through the hatch to the Save Room and store your data so you don't have to fight Serris again. Work your way to the left, past the swinging platforms and tanks. Start running in front of the hatch, just after you enter the Pump Control Unit. When the Speed Booster kicks into high gear, Samus charges through the yellow wall, giving her access to the controls.



Step onto the pressure pad to activate the controls and lower the water level. Drop down underneath the controls and pick up the Missile Tank upgrade. With the water level down, you can safely go anywhere without fear of electrocution. Now you must work your way back to the Navigation Room by using your new Speed Booster ability to smash through walls.

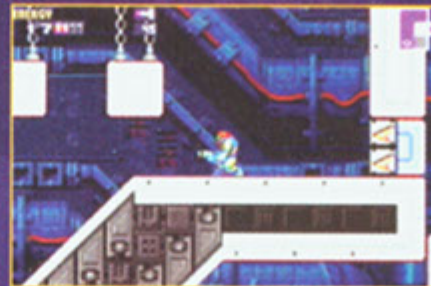
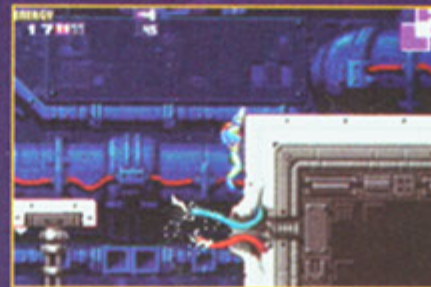

Work your way to the right, blasting through the floor. Continue past the exposed wiring and the hanging platforms. Remember the breakaway blocks we exposed earlier? Go back to the top of the ramp and set off a bomb to confirm the location (pictured above).

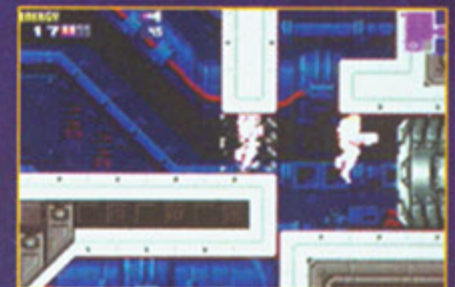

Start at the bottom of the ramp and run up to smash through the blocks. Continue moving to the right, through the blue room. Stop in the Recharge Room for a fill-up, then, after saving your game file, step into the Navigation Room to complete the level.

Sector 3 (PYR)

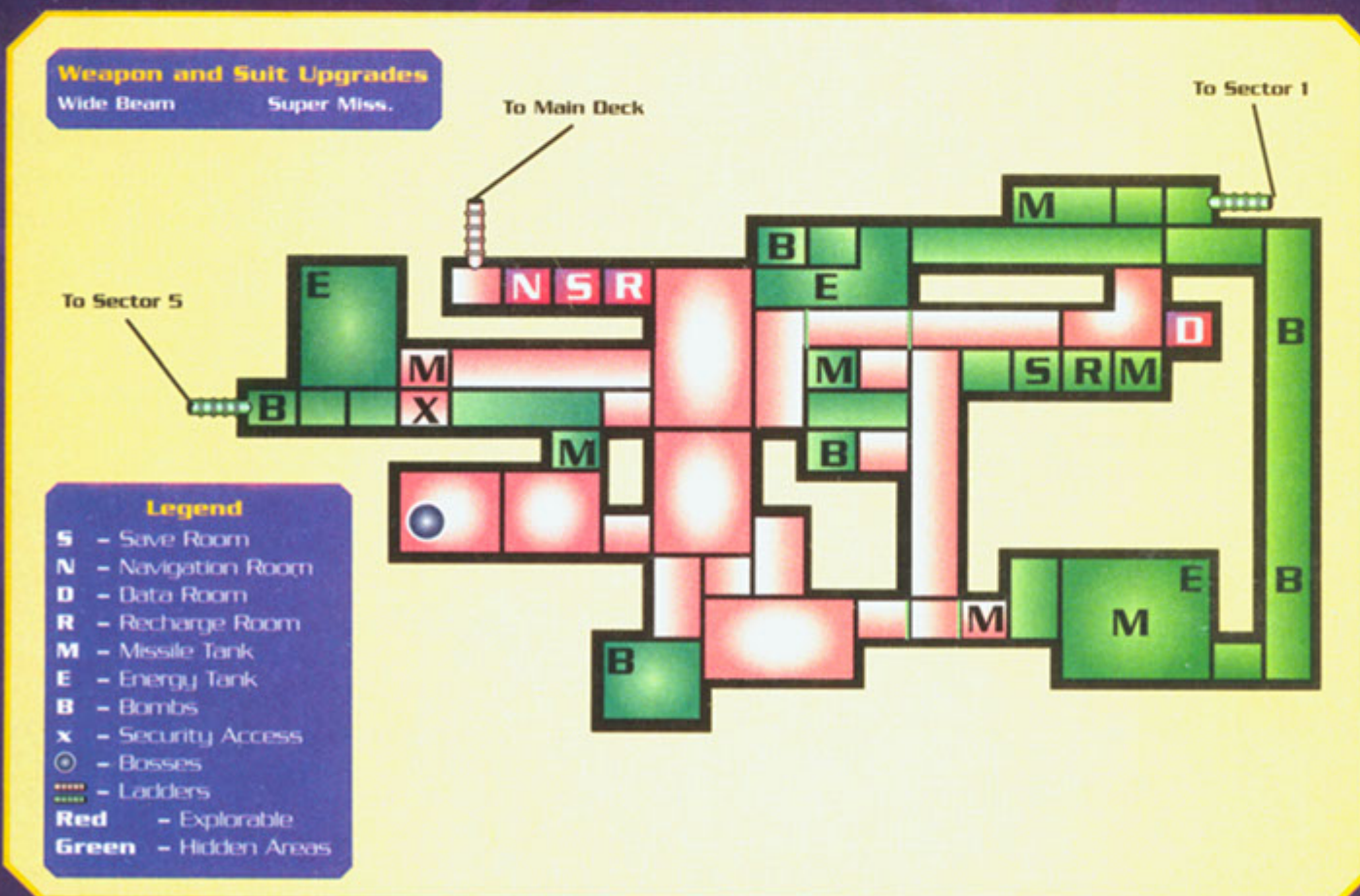

Objective

So Serris had been infected by the X, too.... Well, as a result, you recovered another ability. At this rate you may be able to face the SA-X yet.... But that's still a ways off. HQ has more support data. This time it's Missile upgrade data. You desperately need this, but the Data Room here is sealed with a Level 4 lock, the highest security level. Let's avoid opening sensitive areas unless it's necessary. Also, the route to the Data Room in Sector 2 is blocked by still more SA-X activity. I note a deliberate activity pattern, as if it is blocking your recovery intentionally. Samus, it looks like your best option for this download is in Sector 3 (PYR). You will find the PYR Data Room on your map after using a Navigation Room there. Now, head for Sector 3 (PYR).

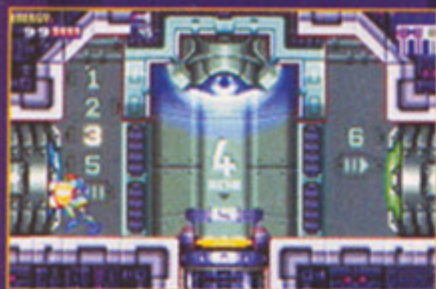

Exit to the right, take the elevator back to the Main Deck, and then continue to the left until you reach the elevator to Sector 3. When you step off the elevator, follow the path to the right to reach the Navigation Room.

Objective

Thankfully, the X have not invaded this area yet.... The Data Room here is sealed by another security hatch. In order to download, you must find the Security Room here and activate Level 2 hatches. This may allow the SA-X and X-parasites into the area.... But we are left with no choice. Your recovery is our main goal. The Data Room is here. As I explained, Security Rooms can't be shown on the map. Be careful Samus, you will see very violent organisms here. And avoid the ultra-heated areas; your suit can't take such high temperatures yet, but we're working on it. Level 2 hatches are green. Release the lock and proceed to the Data Room for download. Super Missile data is ready. Your firepower will triple. First activate green hatches. Then go to the Data Room. There are no ultra-heated areas on this route, so turn back if you enter one.

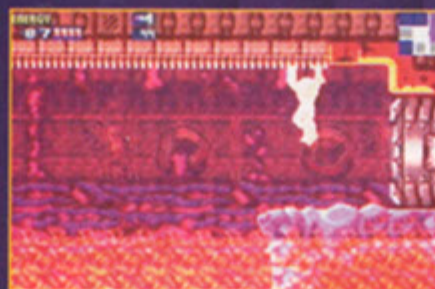
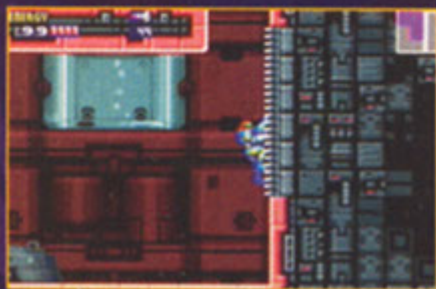

Exit to the right and pass through the Save and Recharge Rooms to reach a large vertical chamber with aquarium windows. Drop down to the ladder on the lower right side of the room and walk over to the white hatch on the left. This hatch leads to an ultra-heated area, so *do not* venture in there, unless you have a death wish. If you insist on exploring this hot box, go back to the Recharge Room to regain your lost energy before continuing.

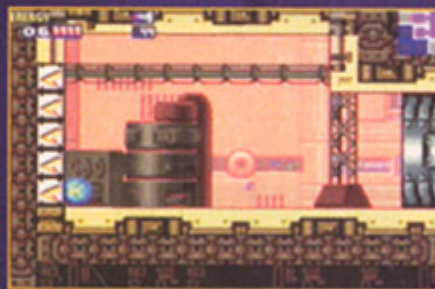
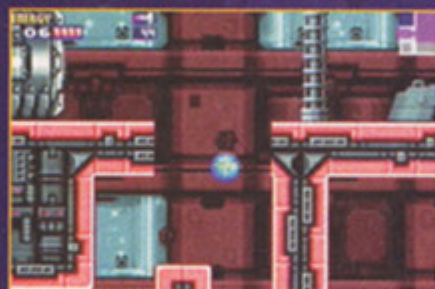

Place a few bombs to the right of the white hatch. The explosion opens the floor, allowing you to drop down to an open door on the left. The door leads to what appears to be a dead end. However, if you place several bombs along the left-hand wall, the explosions reveal Boost Blocks from floor to ceiling.

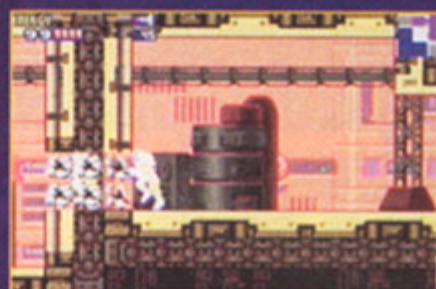
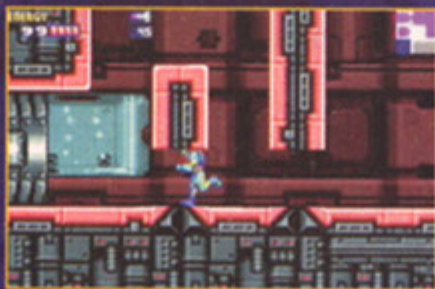

Now, you must clear the path to the right, giving Samus enough room to activate Speed Booster. Blow up four pillars and obstacles, allowing Samus to walk all the way to the hatch on the right. From here, run to the left and plow through the Boost Blocks in the next room.

NOTE

After clearing the pillars and obstacles, don't go through the hatch on the right, or you'll have to clear everything again before Samus can run through the wall.

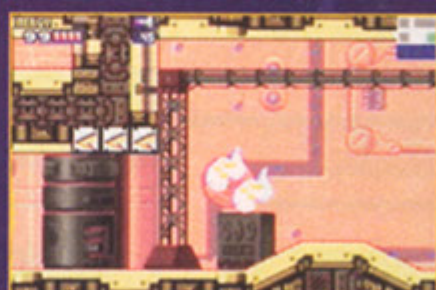

Samus bursts into the next room, which contains a series of ramps. Morph into a ball, jump up, and place a few bombs under the ceiling just to the right of the green hatch. Note the Boost Blocks. Go all the way to the right, run back to the left to engage Speed Booster, and leap

off the last ramp. Samus will go through the Boost Blocks, revealing a small ledge.

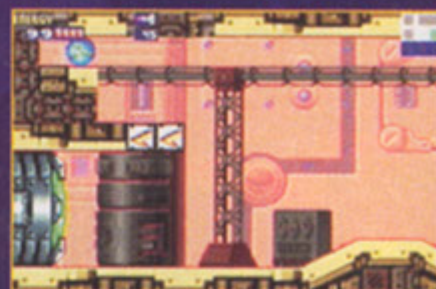

Morph into a ball, hop up to the ledge, and place a bomb to expand the ledge into a tunnel. Continue to the left to enter the Security Room. Step onto the pressure pad to activate the green hatches.

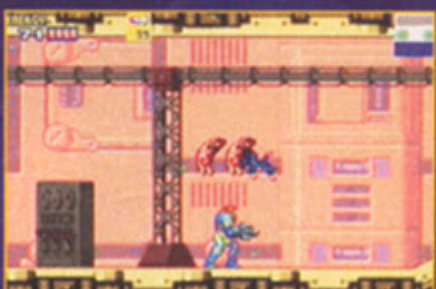

Exit through the green hatch on the right and retrace your path, but look out for the Side Hoppers. This creature bounces erratically, so don't get too close. Your best bet is to shoot when it is on the ground. There is also trouble above from persistent Skree that swoop down at Samus.

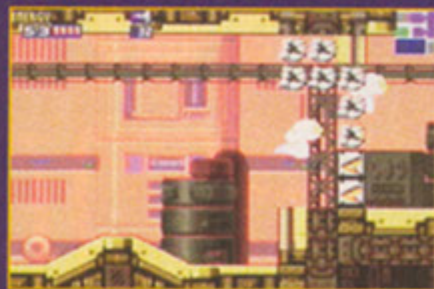
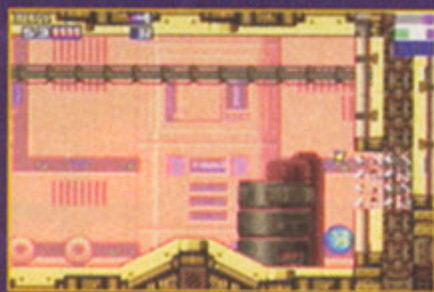

Continue to the right and place bombs along the wall to reveal a ledge. Another bomb exposes Boost Blocks, so use Speed Booster again to gain access to the next room.



Blast your way through the room and exit through the white hatch on the right. Climb up to the ledge and use a Charge Beam to kill the Fune that stretches out from the wall on the right. If you stand at the far left, you can stay out of range while you target the creature. Continue to the right and drop down through the crumbling Pit Blocks to reach the lower level.

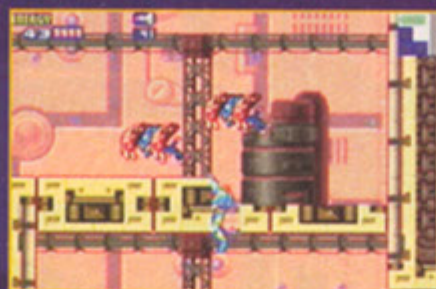
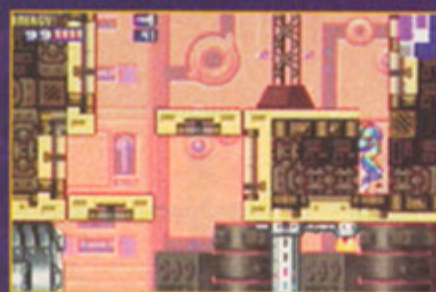

Walk to the right and step on the Pit Blocks to open a hole in the floor. Drop down and exit through the hatch.



Get ready for another Fune attack as you come out of the doorway. Climb up the ladder and go through the white hatch on the left.

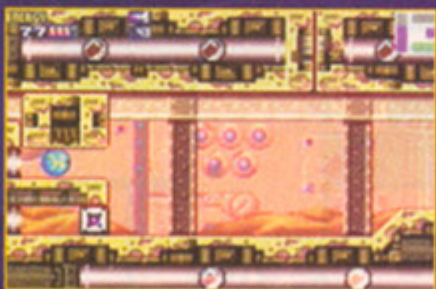

Place bombs along the left-hand wall to reveal two openings. Morph into a ball and jump into

the second opening from the bottom. Follow the tube to reach a Missile Tank.

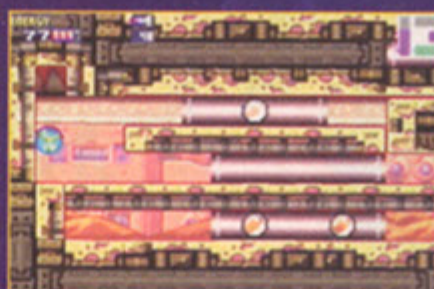

While morphed, jump up into the tube to the left, and set a bomb while in the air. The explosion opens a third tube to the right. Roll through the tube and set off another bomb to open a path overhead. Jump up to the tube and continue to the right.

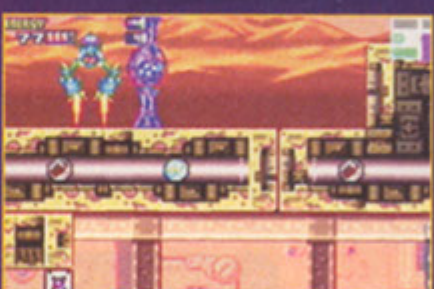

Stop at the midway point and set another bomb to blow open a hole in the tube. Climb up and exit through the green hatch on the right.



You're almost to the Data Room. Walk through the desert landscape to the right, shooting Side Hoppers as you go. Does it seem to be getting hot in here? Take note; it is a tipoff to your upcoming battle with a Security Robot.



Jump up to the ceiling rungs and continue to the right, exiting through the green hatch to reach the Data Room. After Samus acquires Super Missile data, go back two rooms and drop through the opening to reach a Save Room (through the white hatch on the right). A boss battle is coming up, so this is a good time to save your game file.



Exit the Save Room to the right and step on the pad to recharge your weapons and energy. Continue to the right and enter a room guarded by Side Hoppers. Shoot the creatures, then use your newly acquired Super Missiles to destroy the plant. Pick up the Missile Tank and retrace your steps, pausing in the Recharge and Save Game Rooms.



Climb back up through the opening (to the left of the Save Room), then go through the hatch on the right to meet the Security Robot. Jump up to the ceiling rungs and hang on the extreme left. Wait for the robot to walk under Samus, then fire a missile into the top of the robot each time it moves to the left (the top of the robot is the only place susceptible to damage). After several hits, the robot glows white and scurries off to the right. Stay on the ceiling and move to the right. One more hit (this last missile can strike the robot anywhere) blows the Security Robot into a pile of junk.



Somersault up to the ledge on the right, back to the left, and then leap up to the next level. Walk to the left, fighting your way through the Side Hoppers and Skree, and go through the white hatch.



Drop down to the floor. Morph into a ball, hop up, and place a bomb alongside the wall on the left. Bounce up to the opening and continue to the left. When you reach the next wall, bounce up and place another bomb to open a path to the left.

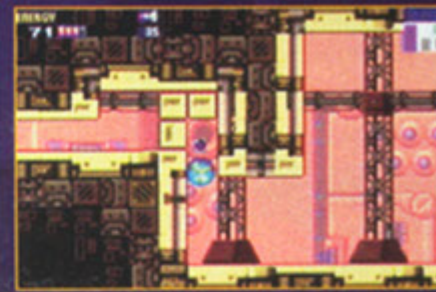

Work your way to the left, killing the Side Hoppers and Skree, and then jump up to the white hatch on the left. Stop at the Recharge and Save Rooms, and then continue to the Navigation Room, where Samus receives her next objective.

Sector 6 (NOC)

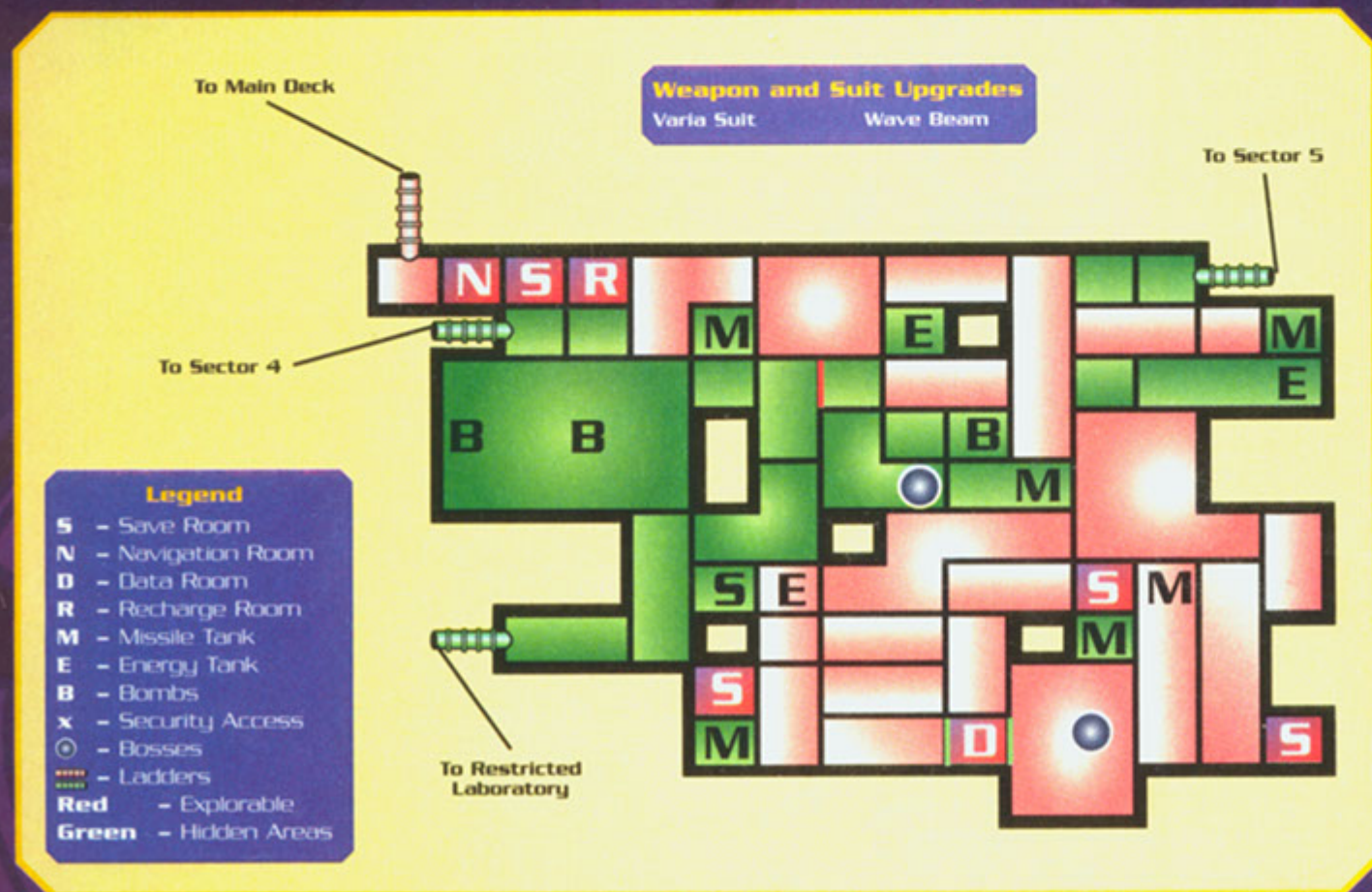

Objective

I see that you encountered a rogue Security Robot. You may destroy it if you meet it again. Your safety is vital. But as to your brief.... Level 2 security locks are released, so Sectors 5 and 6 are open. That means those sectors have likely been infiltrated by X. They are much harder to stop than we initially suspected.... Sector 5 (ARC) is sub-zero. You're still susceptible to cold from the vaccine side-effects, so you'll take damage if you even set foot inside there. Avoid Sector 5 for now, but in the meantime, HQ is working on data to adjust your suit for extreme temperatures. Once we have the transmission, you can download it, but.... The X have destroyed all the Data Rooms you have used so far. I no longer doubt their capacity for critical thought. You'll have to use the Data Room in the night habitat, Sector 6 (NOC). Go to Sector 6 and access a Navigation Room there. Tread lightly, Samus; you are the only one who can do this. And the X may be much more dangerous than we know....

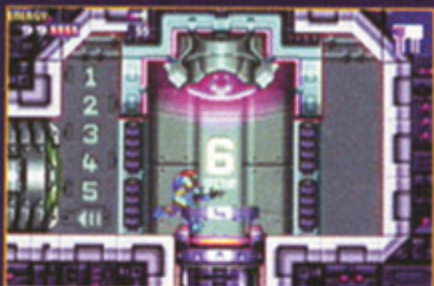
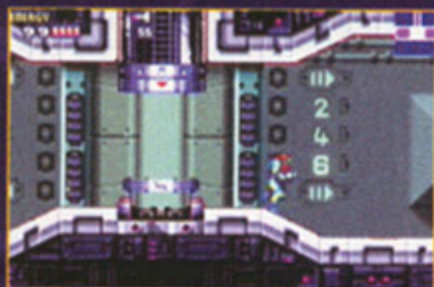

As you ride the elevator back to the Main Deck, you see a strange communication from an unknown source asking if Samus suspects anything. Hmm. Perhaps the computer is not being completely honest. Follow the signs as you continue to the right, and take the elevator down to Sector 6. Stop in the Navigation Room for an update.

Objective

The Varia Suit data is here from HQ and ready to download. Get moving to a Data Room. But there's a problem.... X from the sub-zero sector ARC are in Sector 6 (NOC). And they...they've been changed by the cold. If you absorb one, you'll be frozen from within. This seems like a deliberate tactic. Once you download the Varia Suit modification, you'll be out of danger. Just be extremely careful until then. Remember, avoid the blue X. Use your beam to stun them in order to get by. Be careful. They are hunting you actively now, Samus.... And this area is very dark. Proceed with extreme caution.

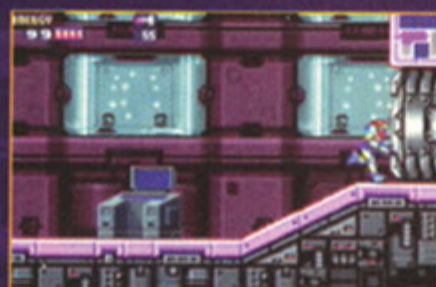

Exit the Navigation Room to the right and stop in the Save Room before continuing into Sector 6. A swarm of Menu attack as soon as you step into the room. These tiny creatures are quick and deadly, so you must fire rapidly to clear the room. Continue to the right, through the white hatch.



Now the fun begins. The sub-zero blue X are just ahead, and although the computer suggests stunning them with your beam, you are better off running past them. Work your way up and down the ledges as quickly as possible. You'll take some damage along the way, but you are likely to die if you stop and fight, so take your licks and keep going.



After jumping down past a ladder (it's faster than climbing), walk through the white hatch on the lower left to enter a large cavern. The blue X attack aggressively here, so don't hang around too long. Walk to the left and plant a bomb to expose the Boost Blocks behind the rock pillar. Now run back to the right and stop at the hatch. Run to the left (don't worry about the X; you can run through their attacks) until Speed Booster kicks in, sending Samus through the pillar to the ladder on the other side.



Climb down the ladder, run to the left, and go through the white hatch to collect a much needed Energy Tank. After collecting the tank, place a few bombs on the platform to expose a hole. Drop down, roll to the right, and fall through the Pit Blocks to the room below.

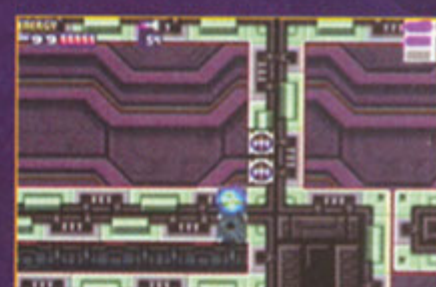

Continue to the right into the next room and place a bomb at the far-right corner. Morph into a ball, drop through the hole, and roll to the left. When you reach the wall, someone, or something, walks into view. It looks very much like Samus, but how could this be?



Suddenly, a massive explosion rocks the room, opening the floor above Samus. The strange creature is gone, so you can hop up and exit to the right. Jump off the ledge and walk through the white hatch to a room filled with Menu.



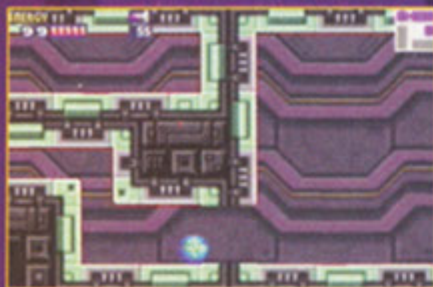

Destroy the creatures, harvest the floating X, and place a bomb in the far left corner to reveal a new path. Climb up and over the barrier to reach the white hatch and go back to the dark room. For now, the blue X are nowhere in sight, so you can continue through the next hatch to the Save Room.



Exit the Save Room and place bombs over the outlined block in the center of the passageway. Continue dropping bombs to clear the blocks, and create a path to the white hatch on the right. Blue X lurk behind the blocks, but don't stop.



Blast your way through another swarm of Menu, climb up and over the rock pillar, and continue left until you run into a giant closed eye that blocks your path to the Data Room. You've battled these guys before, so keep your eye on the eye, and wait until you see the dark spot before firing a missile.

TIP

Remember to jump immediately if the eye is clear, which means an energy blast is forthcoming.



When you destroy the eye, grab the red X (full energy and weapons recharge) before continuing through the green hatch. When you enter the room, you see a strange Core-X sitting on the pressure pad. You can shoot it, but nothing will stop the Core-X from stealing the Varia Suit data. Pursue the Core-X into the next room.

CAUTION

Although the Data Room scene looks like a movie sequence, the Core-X is active and dangerous, so don't get too close. It is better to let it escape to the next room, where you can do battle in a more spacious environment.



Jump to the second platform from the left, where you can quickly adjust your aim and shoot the Core-X with Charge Beams as it flies around the room. If the Core-X bumps you, use the + Control Pad to float back to the platform (dropping into the water wastes time and leaves Samus vulnerable to attack). When the Core-X changes shape, switch to missiles. You'll need to jump around more and scoop up floating X to maintain your strength as you keep firing. When the remaining Core-X turns red, it is one shot away from destruction.



Varia Suit effect recovered. Survive extreme temperatures.



With Samus snug and warm in her new Varia Suit, hop across the platforms and exit to the right. Continue through the small corridor to the next room, where the blue X flock to Samus. Now you can absorb them for energy, just like the other X, so there is nothing to fear.



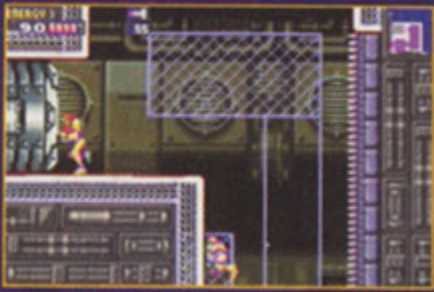

Climb the ladder and exit to the right through the white hatch at the top. Watch out for the Bull, a new flying enemy that flies straight at Samus. Clear a path to the ladder, somersault over to the left, and exit through the white hatch.



Morph into a ball and work your way back through the first of the dark rooms, using bombs to clear a path. Follow the path through the cavern and absorb blue X at will.

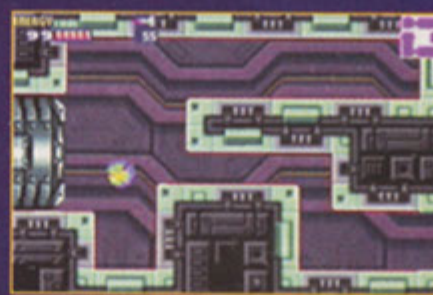

Use a bomb to drop through the floor, back to the room where you saw the Samus look-alike. Retrace your path, morphing when needed, until you reach the Save Room (above and to the left of the room with the large explodable blocks). Save your game to protect your recent victory over the Core-X and acquisition of the Varia Suit. Exit the Save Room and use several bombs to drop down through the floor and expose a path to the white hatch below and to the right.



Return to the room where you first encountered the blue X. Exit through the white hatch and carve a path through the flying Menu to reach the Recharge Room. After bringing Samus back to full energy and weapons, exit to the left to reach the Navigation Room, where the computer is ready with a new objective.

Sector 5 (ARC)

Weapon and Suit Upgrades

Ice Missiles
Gravity Suit
Super Bomb

Legend

- S - Save Room
- N - Navigation Room
- D - Data Room
- R - Recharge Room
- M - Missile Tank
- E - Energy Tank
- B - Bombs
- X - Security Access
- - Bosses
- - Ladders
- Red - Explorable
- Green - Hidden Areas

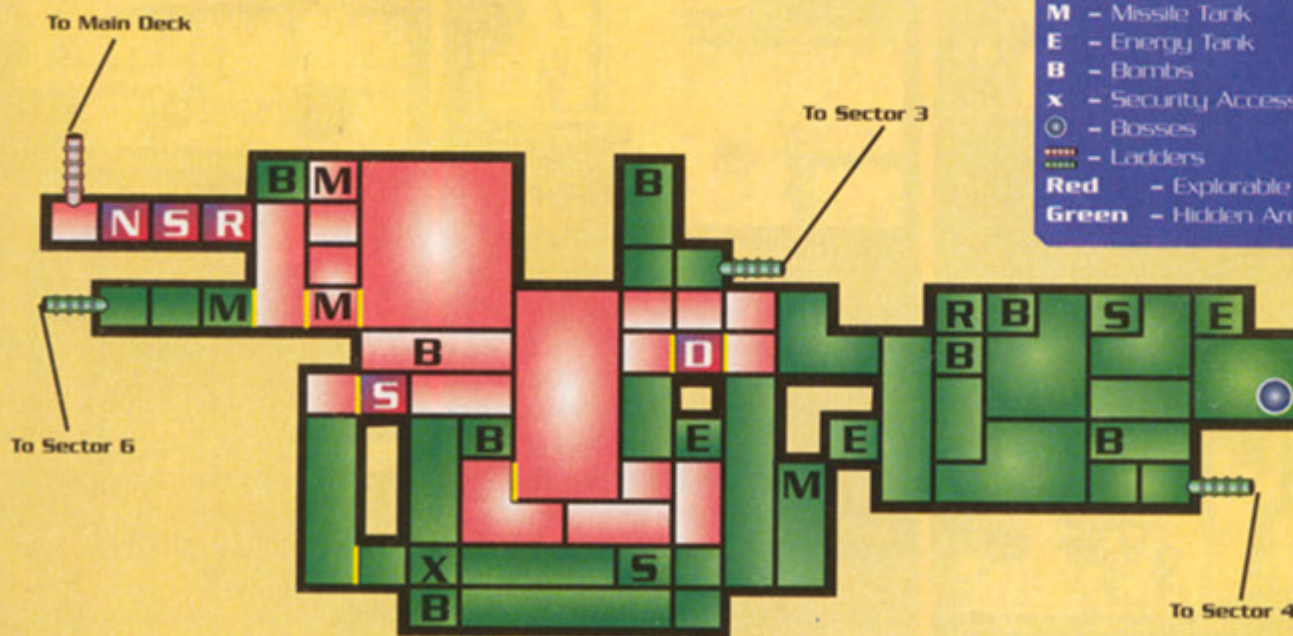

Objective

How did that X download the Varia Suit data? This doesn't seem to make any sense at all, unless the X... Unless the X have the ability to process data organically.... At any rate, you have the Varia Suit data. Now you will be protected from extreme temperatures. More importantly, the SA-X will no longer be able to freeze you, so you can escape easier. But you're still too weak. That thing is too much for you. You currently have no way of damaging it. But my simulations indicate that a penetrating weapon like the Plasma Beam might work. Developing modification data will take HQ some time, though. There's also a chance that you may be able to restore your Plasma Beam by absorbing a large Core-X, as you did with the Charge Beam function. As for restoring Ice Beam functionality, I doubt it.... Your current cellular makeup would reject that addition. Therefore, HQ has developed an Ice Missile upgrade. This will add a freezing effect to your Missiles. It will help. Go to Sector 5 (ARC) for the download. Now, get moving.

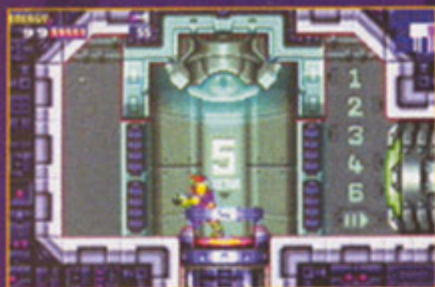

Take the elevator back to the Main Deck and follow the signs to the Sector 5 elevator. Exit through the white hatch to reach the Navigation Room and receive further instructions.

Objective

You need to download data for the Ice Missile upgrade, but, as you might expect, the Data Room here is secured. Level 3 security hatches are yellow. Release the security lock and download data as usual. And experiment with those new missiles. They will be helpful.... You know what to do. Go to it.

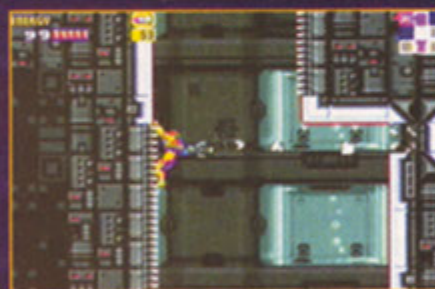

Exit to the right and proceed through the Save and Recharge Rooms until you reach the next room. Climb down to the second ladder on the left and hang on the top rung. Fire missiles to the right to open a tunnel in the wall. Hop down to the ledge, leap up to the opening, and then morph into a ball to continue into the next room.

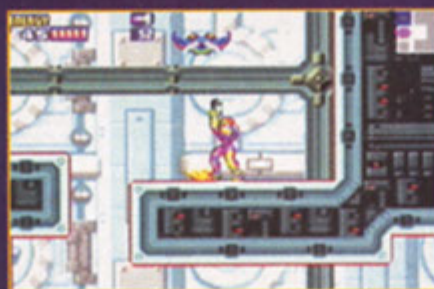

Shoot the Bull hanging on the ceiling and proceed through the white hatch. In the next room you meet a rather humorous new enemy, the Choot. In its dormant state, the Choot lies on the ground, but when you approach, it rises in the air and spits at you as it floats back down. After it begins to move up, back away, then shoot it on the way down.

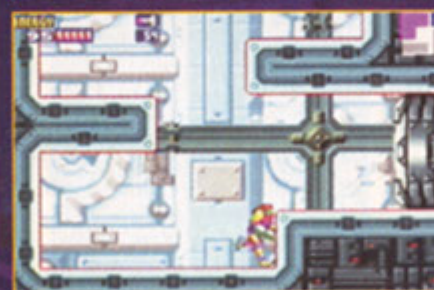

Drop down, continue to the right, and climb the ladder. Work your way back down the other side, shooting the Choots along the way, and go through the white hatch on the lower level.



In this room you face the Waver, a new airborne creature that rushes you, and if you get out of the way, eventually embeds itself briefly in the wall. These enemies move quickly, but they are vulnerable when they stick to the wall, so don't miss an opportunity to vaporize them. Continue down until you reach a ledge that falls away after you place a bomb.



Walk down the short ramp and place a few bombs near the wall to expose the Boost Blocks. Now you must clear a path to the left so Samus can run far enough to activate Speed Booster. Clear the Bulls from the next room, then run from left to right through the white hatch, past the two ramps, and onto the floor. The floor tiles give way, dropping Samus to the ledge below.

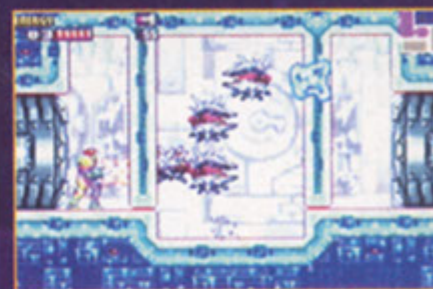

Continue to the left and drop to the lower level. Morph into a ball and place a bomb alongside the single block underneath the pillar. Continue through the doorway, where a squadron of Wavers waits on the other side of a narrow barrier. A single bomb takes care of the barrier, but get ready for a nasty attack.

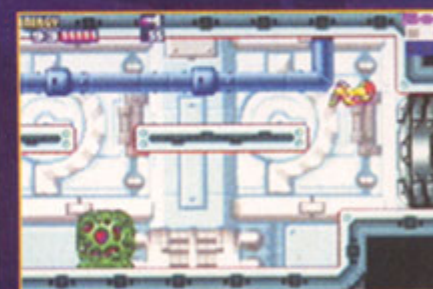

Continue through the open doorway to the right, drop down a level, and go back to the left through the white hatch. Jump to the left, over the obstacle, and explode the floor to drop down to the next level.



Go through the white hatch to reach the Save Room. Continue to the left through a short corridor to reach the Security Room. Step on the pressure pad to release the yellow hatches.

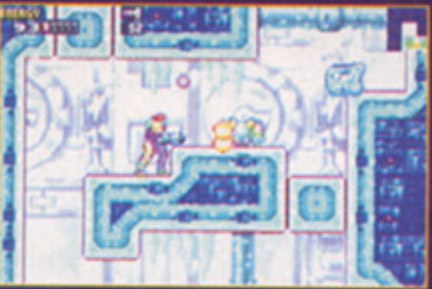

Exit to the left through the yellow hatch and work your way up and around the ledges. The small connecting blocks are Pit Blocks that crumble under Samus's feet, so avoid them as you leap between the ledges.

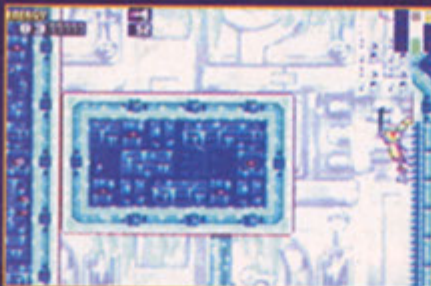
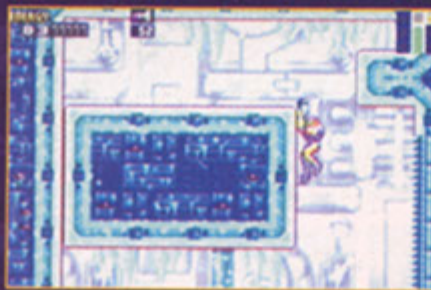

When you reach the top of the ladder on the right side of the room, you must jump across to the platform on the left. However, the overhang prevents Samus from getting close enough to hang on the ledge. Blast away at the overhang to clear enough room for the jump.

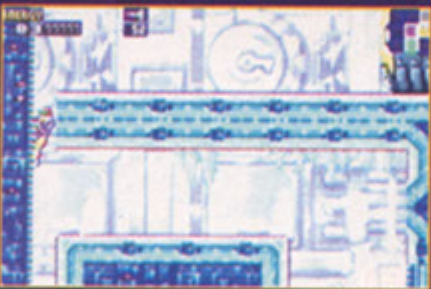

Place bombs on the far left side of the platform to expose a ladder on the left-hand wall. Climb up to the next ledge and exit through the Yellow hatch.

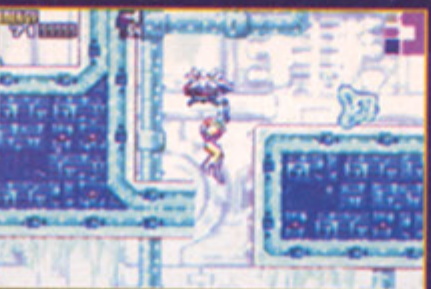

Ice effect added to Missiles. Use it to freeze enemies.

Save your game file, then exit to the right. Shoot the red light to raise the shutter, blast the Bulls in your way, and exit to the right. Shoot a hole in the ceiling and climb up to the next ledge. Go through the white hatch, open another shutter, and enter the Data Room to receive the Ice Missile upgrade.

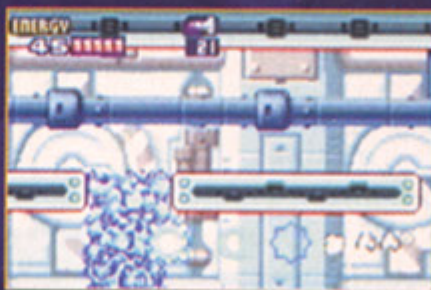
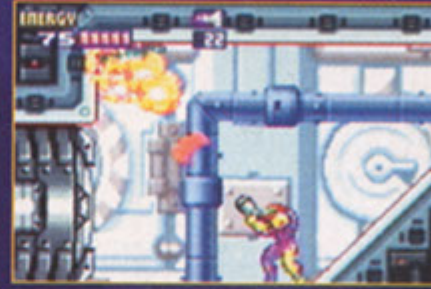

From the Data Room, make your way back down to the room directly above the Save Room. Kill the Bull when it reaches the left-hand corner of the ceiling, but don't grab the X. Instead, let it infect the plant on the floor, causing it to grow and fill the space between the two platforms. Use an Ice Missile to freeze the plant so you can run across it without taking damage (which slows you down).

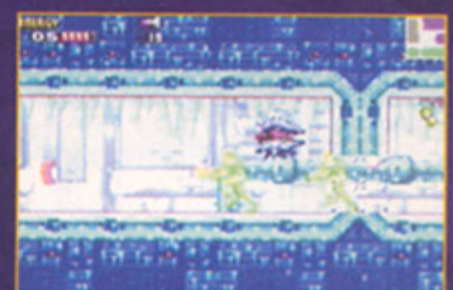

Engage Speed Booster by running from right to left, through the door, and through the wall (Boost Blocks). Climb to the next level and exit through the yellow hatch.

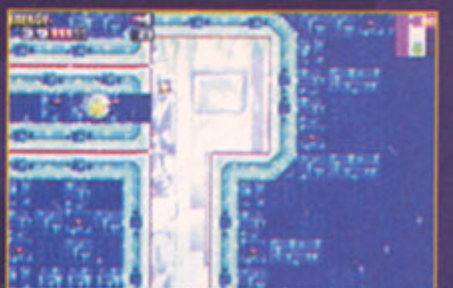
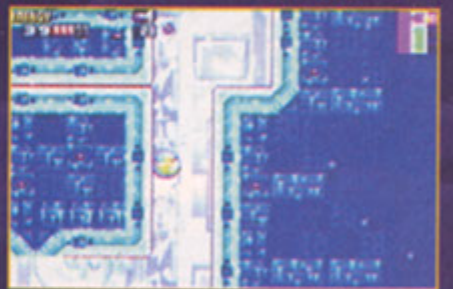
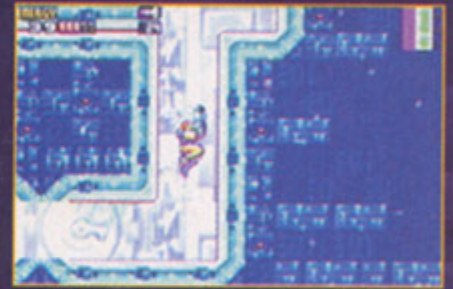

Work your way up through the center of the map until you reach what appears to be a dead end. Morph into a ball and leap from the ledge to the opposite wall, leaving a bomb in midair. The explosion bores a tunnel in the wall. Climb back up to the ledge, morph into a ball, and leap into the tunnel.



Ignore the Boost Blocks you see when Samus drops out of the tube. You'll use these later. Instead, jump up through the opening and keep moving toward the top of the room. Go through the doorway on the left, which takes you into an even larger, vertical room. Your destination, the Navigation Room is up and to the left from here.

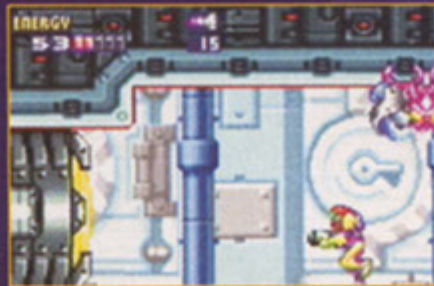

Climb up using ledges and a ladder on the right-hand wall. Shoot the comical Choots as you go; then drop down another ladder on the left-hand wall. Follow the path to reach a small room, where you encounter a new enemy, a Dessgeega hanging from the ceiling. It is very powerful, but fortunately does not fire at Samus. However, it drops down periodically, so you are better off simply running through the room.

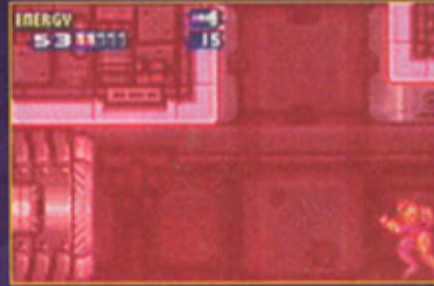

In the next room, the walls are flashing red as you hear an announcement about an emergency in Sector 3. Use the ladders to reach the white hatch on the upper left. Stop for a much-needed recharge, save your game, and continue to the Navigation Room, where you receive a new, and extremely difficult, objective.



Sector 3 (PYR)

Weapon and Suit Upgrades

Wide Beam Super Miss.

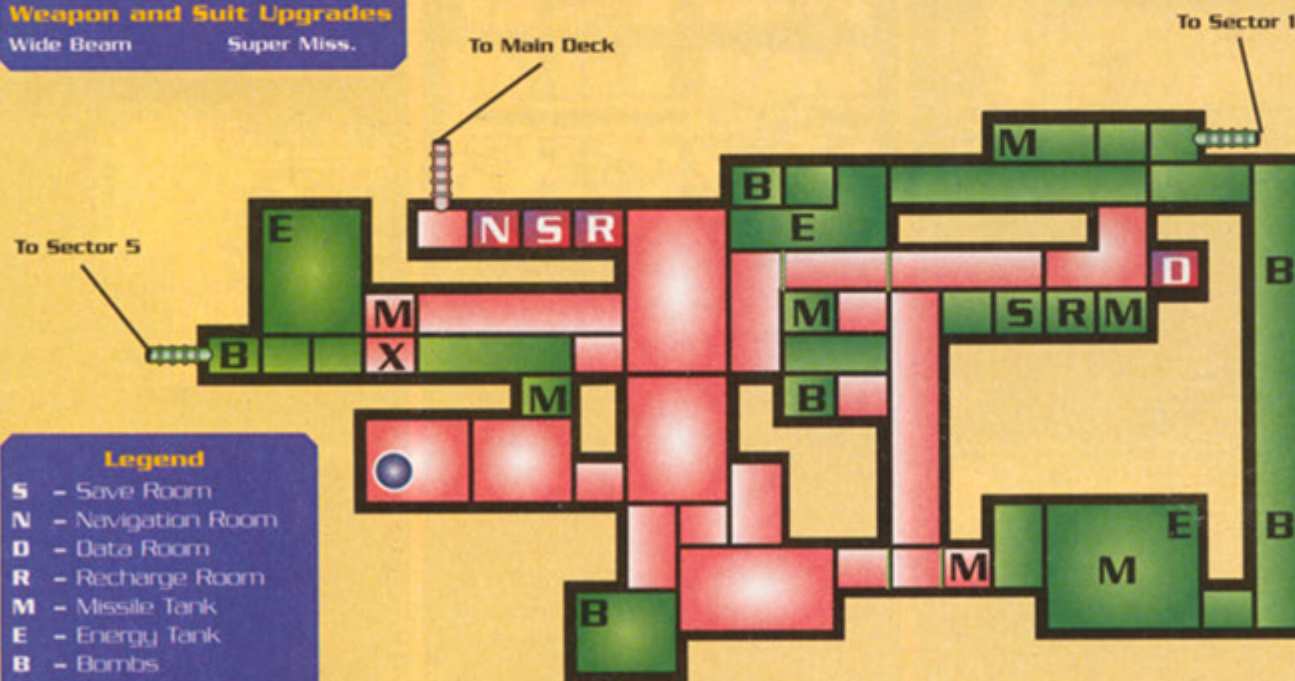

Legend

- S - Save Room
- N - Navigation Room
- D - Data Room
- R - Recharge Room
- M - Missile Tank
- E - Energy Tank
- B - Bombs
- X - Security Access
- - Bosses
- - Ladders
- Red - Explorable
- Green - Hidden Areas

Objective

Emergency in Sector 3 (PYR). The area could melt down soon. It seems the Main Boiler's cooling unit is malfunctioning. This could easily destroy the entire research station, as it would likely trigger the auto-destruct explosives. We have about six minutes. Hurry to Sector 3 and access the control room to the side of the Main Boiler room. Most of the systems in the PYR are down because of this.... Again, we know who to blame. The SA-X must have hacked into the system control file. What impressive intelligence. There's little time. Hurry to the Control Room in Sector 3.

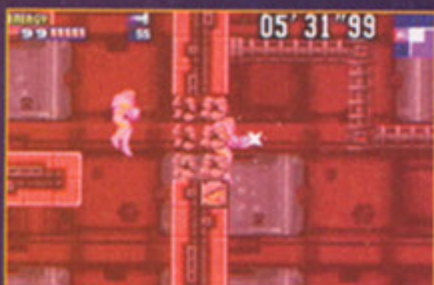

Exit the Navigation Room to the left, take the elevator back to the Main Deck, and then run quickly to the right, toward the Sector 3 elevator. When you arrive at Sector 3, run through the Navigation, Save, and Recharge Rooms. By the time you exit the last room, Samus is in Speed Booster mode, sending her through the wall and thereby saving precious seconds.

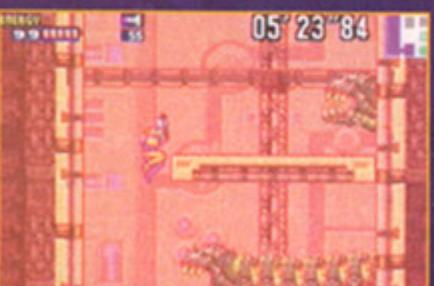
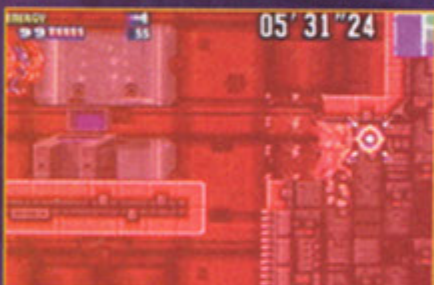

The Speed Booster launches Samus through another wall, eventually depositing her in front of a white hatch. In the next room, work your way up the ledges, avoiding the Fune that extend from the walls. When you reach the top, exit to the right through the green hatch.



In the next room, shoot, or avoid the Side Hopper, then blast through the plant. Place a bomb just before the ledge to open a hole in the floor, then drop down. Roll through the short tube and exit through the white hatch.



Drop straight down (the ladder is slower) past the Fune until you reach a ledge where a fiery Mella stands guard. You'll likely take a hit, but there's no need to stop and fight. Jump down past more Fune until you reach two green hatches. Exit to the left.



Five minutes to go. Jump up to the ceiling rungs and make your way carefully over the lava pool. Two enemies try to knock Samus into the lava. First, a series of fireballs come up from below. Time your movement to avoid the blasts. Second, a persistent Dessgeega attacks from the air, making it difficult to hold the ladder. Shoot quickly while you are hanging, or drop down on the rocks for firmer ground.

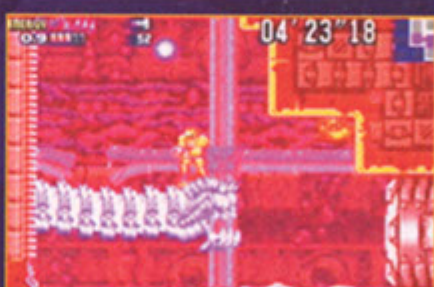
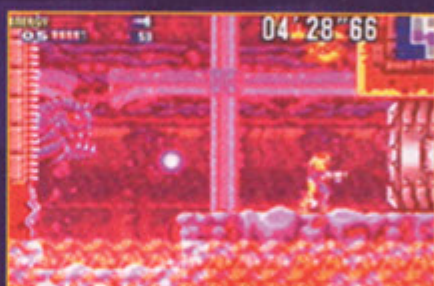

After making it through your first trial by fire, exit through the white hatch on the left. It doesn't get any easier. The next room is also on fire, and you must climb a ladder while Fune spit fireballs at you. Freeze the first one with an Ice Missile and use it as a step to reach the ledge.

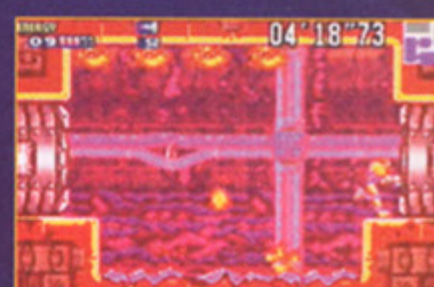

Exit through the white hatch and run quickly through the next room, avoiding the Mella spitting fire from above. More Fune wait in the next room. Again, use the Ice Missiles to turn them into steps and work your way to the top.



The next room has more Fune and Mella. Freeze (or destroy) them as you move to the left and down to a white hatch in the lower-left corner of the room.





Continue through the next short corridor and go through the white hatch to reach the Main Boiler. Knock out the Side Hoppers and jump up two ledges. Continue to the left and destroy the giant eye guarding a hatch. Grab the floating red X and continue into the Control Room. You should have about two minutes remaining.



Walk down the steps until you reach a pressure pad where a scientist appears to be working. It is actually an X-parasite taking another form. Shoot it with missiles to release the Core-X. You must nail this Core-X in the eye to inflict damage, so keep jumping around to position Samus for a good shot. When the Core-X disintegrates, jump up and snatch the remaining red X cluster to regain Samus's Wide Beam ability. Now your beam attack will take out a wider field of enemies.



Step back onto the pressure pad to repair the Cooling Unit and avert disaster. Go back through the Main Boiler Room, shooting Side Hoppers along the way, and exit through the white hatch. Instead of climbing back up the ladder, shoot the Mella and jump across to the white hatch on the right.



Follow the path up and over the ledges as you work your way back through the fire rooms, including the treacherous journey across the ceiling rungs. Continue up the ladders past the Fune as you move toward the Navigation Room in the upper left-hand corner of the map.

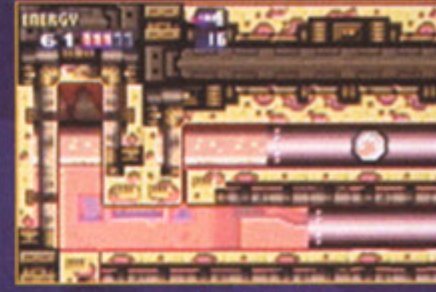
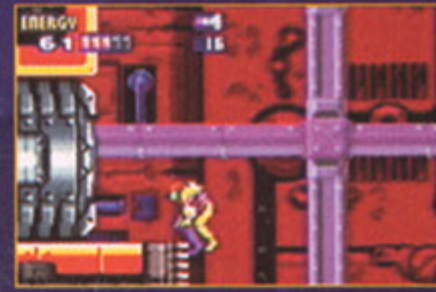

At the top of the ladder, exit through the white hatch on the left. Morph into a ball and place a bomb on the floor to gain access to the tubes on the left. Samus falls through a Pit Block to a lower chamber, where you can shoot the blue light to raise a shutter. Continue through the white hatch to enter a large, vertical chamber.



Work your way up the ledges to the white hatch on the left. Now you're home free. Stop at the Recharge Room, save your game file, and then step into the Navigation Room to receive a new objective.



Main Deck

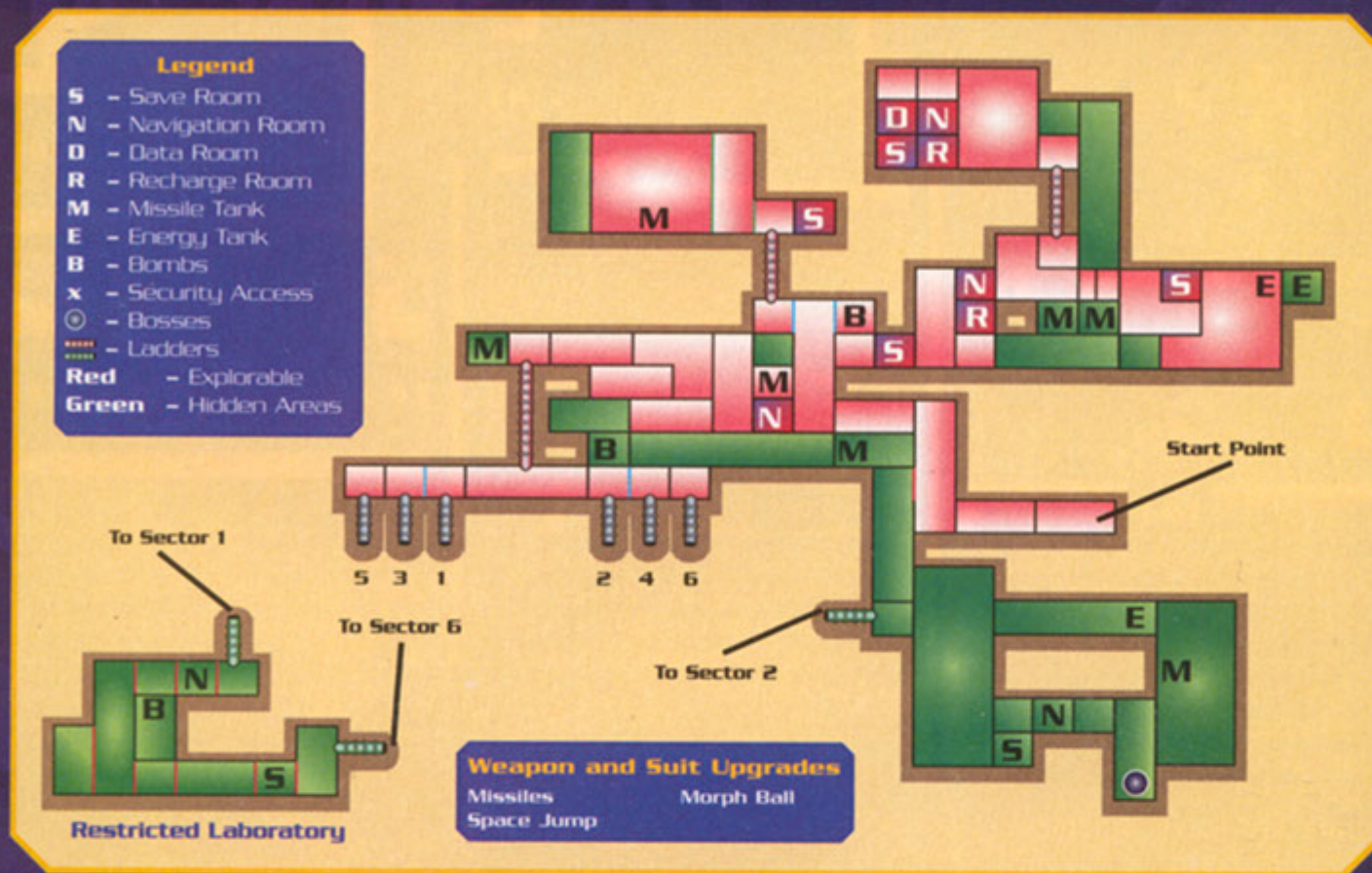

Main Deck map

Objective

The X mimicked a crew member...it all makes sense now. The X can absorb the memories and knowledge of their prey. What an astounding find. HQ was very impressed. But don't you find it strange? This could have destroyed the station with the X in it, not to mention the SA-X. Unusual for a self-preserving species like the X. Unless.... Your presence is an even greater threat, a threat to the existence of X elsewhere.... This is only a hypothesis.... Perhaps.... Their survival instinct is in conflict with their newly borrowed intelligence.... Don't let your guard down yet. The X are still a threat. Samus, I see bio-signs on the Habitation Deck. Survivors? The infected crewman you saw had survived until recently. Maybe there's a chance.... The signs emanate from here. I have just restored power to the Main Elevator. Use it to return and look for any survivors.



Take the elevators back to the Main Deck and continue to the right. Walk to the right-hand corner, morph into a ball, and roll into the next room. Your destination is directly above, but without direct access, you must first go to the middle of the map and then take another elevator to reach the Habitation Deck.

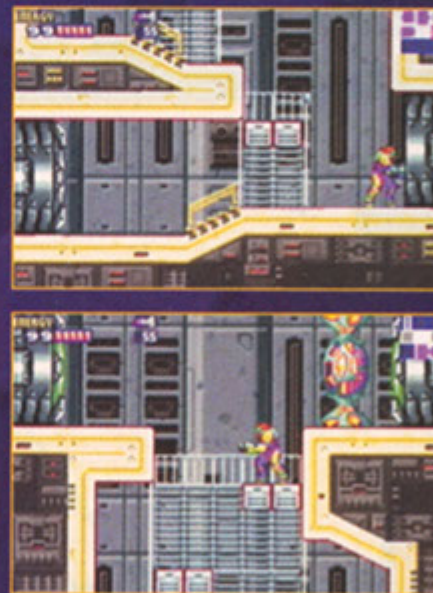

Cross over to the next doorway, then work your way down the ledges and stairs to reach a doorway in the lower-right corner. Go through the Navigation Room, then hop from platform to platform to reach the green hatch in the upper-left corner of the room. Go through the hatch to reach the Habitation Deck elevator.



Your target is up and to the left, but you might want to pop into the Save Room to the right of the elevator and store your game file. Go back to the left through the green hatch. Shoot an Ice Missile at the Fune (when it is fully extended). Jump up on the frozen head to make your way to the next ledge, then freeze the second Fune to complete your journey to the second green hatch on the left.

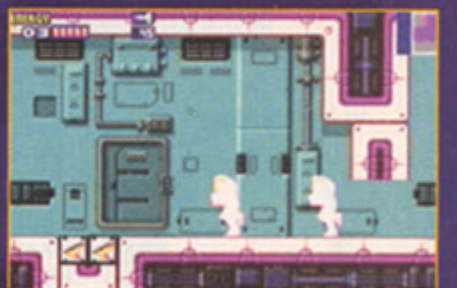

Go through the green hatch to reach the Habitation Deck, where you find an assortment of odd creatures cavorting around on the other side of the glass. You must figure out how to free the creatures, but for now, you can collect an easy Missile Tank upgrade. Walk to the second floor block and place a bomb. When the floor opens, step on the remaining block to fall down to the next level. Shoot through the barrier on the left, then walk back to the hatch on the right. Start running from here to race over the Boost Blocks and fall down to the next level.

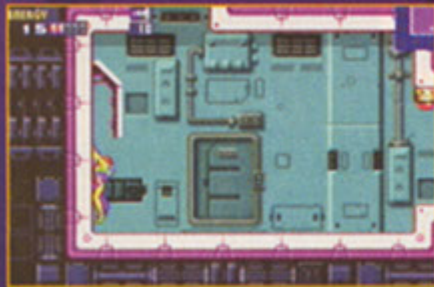

Open the shutter to your right and continue to the Missile Tank upgrade. Walk back through the open shutter until you reach the left-hand wall. Note the broken panel hanging off the wall. Jump up and grab the hidden ledge and continue into the tunnel.



Climb up the ladders, freezing the Fune as you go. When you reach the top, go to the right and enter the Habitation room. Step on the pressure pad to release the Etecoons and Dachoras. The motley crew scurries off to the right as you receive new instructions to proceed to the Navigation Room.

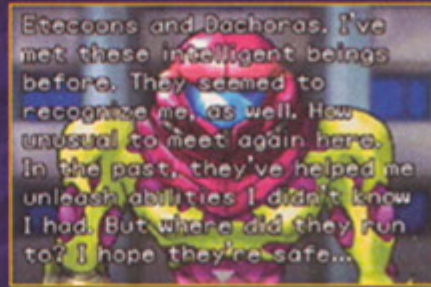
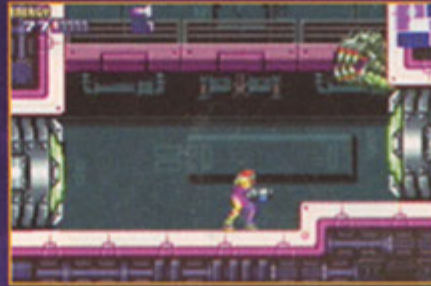

Exit to the right, drop down to the floor, and go through the green hatch on the right to reach the elevator. Proceed back down to the Main Deck.



Go to the right and use the platforms to descend all the way to the floor. Exit through the white hatch on the left to reach the Navigation Room, where you receive a new objective to find a Power Bomb upgrade in Sector 5.

Sector 5 (ARC)



Weapon and Suit Upgrades

- Ice Missiles
- Gravity Suit
- Super Bomb

Legend

- S** - Save Room
- N** - Navigation Room
- D** - Data Room
- R** - Recharge Room
- M** - Missile Tank
- E** - Energy Tank
- B** - Bombs
- X** - Security Access
- ⊙ - Bosses
- ⋯ - Ladders
- Red** - Explorable
- Green** - Hidden Areas

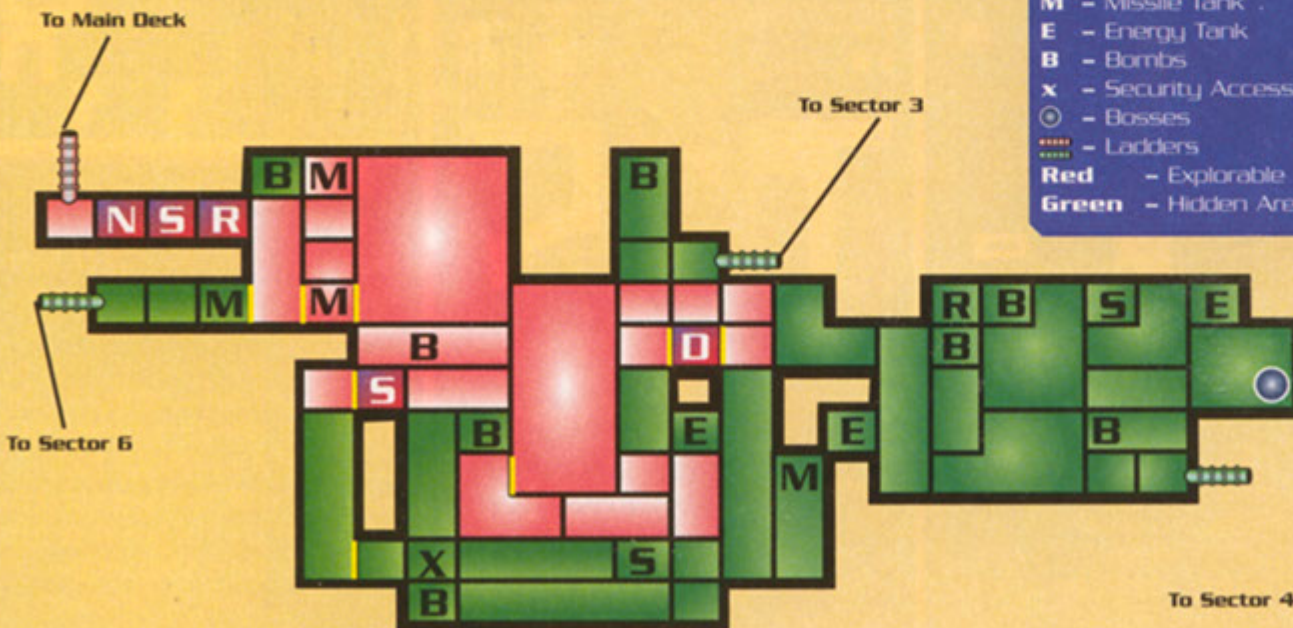

Objective

So the survivors were not human.... Most unfortunate. We can now confirm the deaths of all crew members. I imagined this was the case, but I had hoped it wasn't. I believe the X only infected the humans for knowledge.... That form is too weak for battle. I am sure the others were merely food for the X.... Samus, I think they are evolving, growing stronger. Some are now appearing that resist your current weapons. HQ anticipated this and sent Power Bomb data as soon as the hardware team finished it. Download it immediately. Our choice of Data Rooms is limited to this one in Sector 5 (ARC). Go. Now.

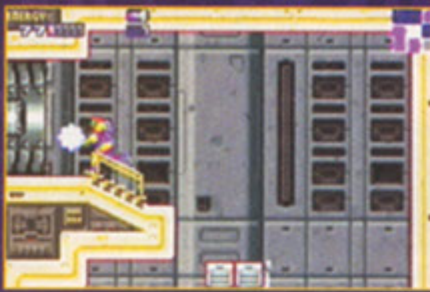

Exit to the left, climb up the platforms, and go through the white hatch on the left. Jump across the opening, morph into a ball, and continue into the next room.



Go through the white hatch and continue down the corridor to reach the Main Deck elevator. Run to the last elevator platform on the left and take it down to Sector 5. Go right to the Navigation Room for further instructions.

Objective

You've been to this Data Room before, but I'll show you its position again. Now, move out.



Stop in the Save and Recharge Rooms on your way to the next vertical chamber. Bulls attack from all directions, so clear the way before climbing down the ladder. When you reach the bottom, go through the yellow hatch on the right.



Race through the short corridor and into the next room, where the Choots attack from above. As you work your way up and to the right, a huge shadow zooms back and forth. Something big and nasty is waiting for Samus.



Go through the white hatch in the lower-right corner. Watch out for the Wavers, spinning and zooming back and forth as you work your way down to the white hatch in the lower-right corner of the room.



Raise the shutter and continue through the yellow hatch to reach the Data Room. Step onto the pressure pad to receive the Power Bomb upgrade. Exit to the right and place a few bombs to open the floor and drop down.

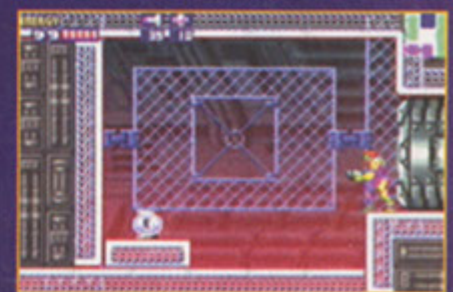

Climb up the ladder on the right, freeze one of the Rippers, and hop up to the white hatch on the left. Go inside the room to collect what appears to be an Energy Tank.

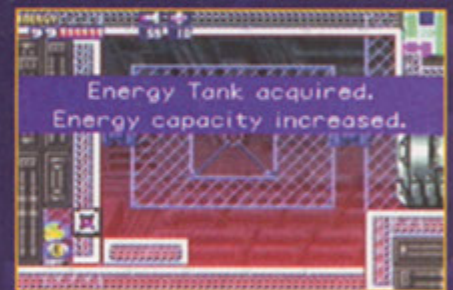

Surprise! Shoot the imposter, scoop up the red X for a maximum recharge, and then lay some bombs against the left-hand wall to reveal the real Energy Tank.





Exit to the right and work your way down the long vertical shaft until you reach the room to the right of the Save Room. Place one of your newly acquired Power Bombs on the floor to expose a hole. As you can see, a single Power Bomb sends a mighty shock wave in all directions to do the work of a couple dozen regular bombs. When you drop down, run through the white hatch, and keep running until you reach a barrier.



Without hesitation, leap up and over the obstacle, because the SA-X has finally caught up to Samus, and he is only a few steps away. Fortunately, you'll be safe on the other side of the barrier, at least for now.



Wait until the SA-X walks away (his footsteps grow fainter), then place a Power Bomb to reveal two openings in the wall. Jump up to the higher one (the lower one is a dead end). You must move quickly, because along with the openings, the Power Bomb also blows away the barrier, exposing Samus to the SA-X.

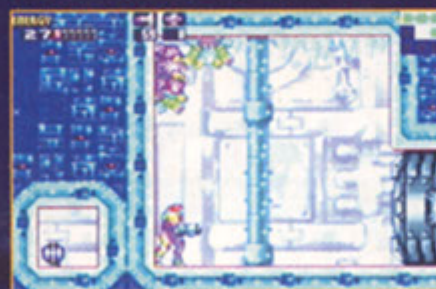

The SA-X catches up to Samus in the next room, so just keep running. You absorb a few hits, but you don't have the firepower to turn around and fight, so just keep going. When you reach the next room, the SA-X temporarily gives up the chase.



Shoot the Bulls overhead, then set off a Power Bomb to expose the Power Bomb Tank in the alcove on the left. Grab it and climb up to the white hatch on the upper-left ledge. Go through the Security Room and out the other side.

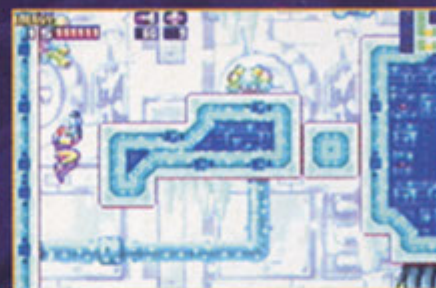

Climb up the ledges, shoot the Bulls, and work your way up the ledges and ladder (stay away from the blocks; they will crumble and drop Samus to the ground).

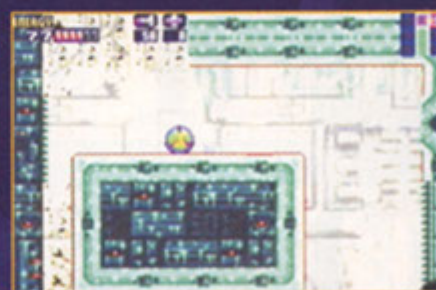

When you reach the top, set off a Power Bomb to expose a ladder on the left-hand wall, along with access to the upper ledge. Climb up and exit through the open doorway to reach a Save Room.

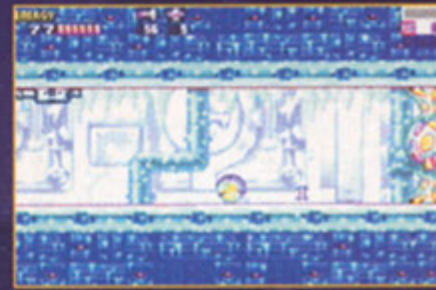

Open the shutter and continue to the right. Place a Power Bomb to vaporize the plant, then go through the doorway to the next room. Jump up to the next ledge and keep moving up to reach the white hatch in the left-hand corner.



Climb the ledges to reach the ladder on the right-hand wall. Take the ladder to the top, jump over to the left, and climb down the second ladder. Continue moving to the left, through the yellow hatch. Run through the short corridor and work your way up two ladders in the next room to reach a white hatch on the left side. Stop in the Recharge Room to boost Samus's energy and weapons, then continue to the Save Room. The next hatch takes you to the Navigation Room, where the computer directs Samus back to the Main Deck and a terrifying confrontation with the most powerful enemy to date.

Main Deck

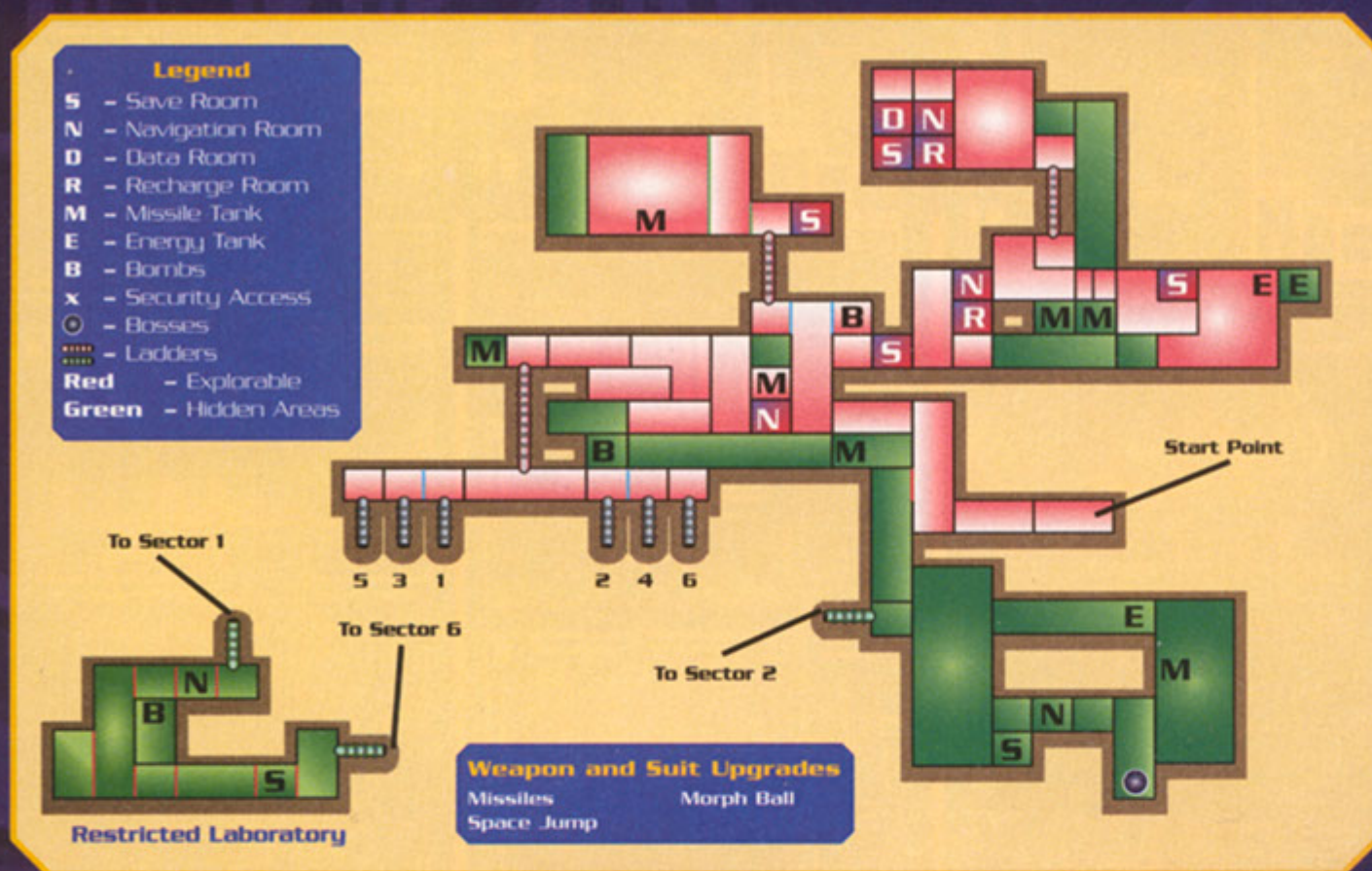

Samus drops into a frosty room that holds what appears to be a frozen creature. As you continue to the right, the creature's lifeless eye suddenly turns red, and a red X cluster floats away as the frozen creature crumbles to the ground. When you continue to the right, Samus drops through a Pit Block to the room below.



Samus falls all the way back into the original tunnel. As you walk to the right, you reach a new and disgusting creature, the Alcoon, that spits fire from above. You can easily time your advance to miss the droplets, but while you're dodging fire, don't forget about the Zeros shuffling toward Samus.

Objective

Samus, return to your ship. I have important information.

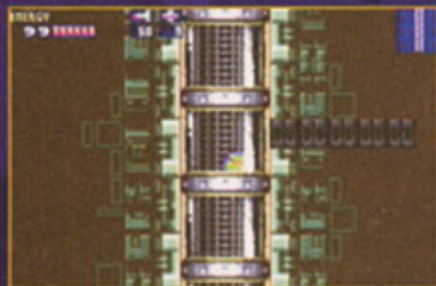

Exit to the left and take the Sector 5 elevator back to the large bank of elevators. Walk to the right to reach the Main Deck elevator. As it ascends, the elevator suddenly stops. Place a Power Bomb to reveal an exit path to the right.



Morph into a ball, roll to the right, and jump up and around the right angle turn. Note the Fake Block at the end of the tube, and another one directly below it (the blocks look crumpled). Samus falls down through the Fake Blocks into a chamber below.

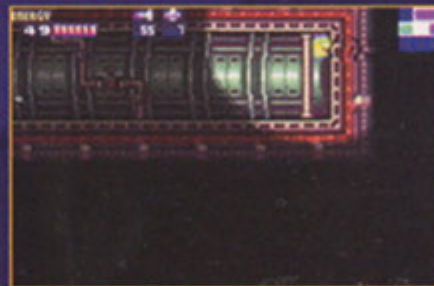

Shoot the Zeros as they cruise along the floor and ceiling of the tunnel, and continue to the right. Another Fake Block is at the end of the tunnel, near the ceiling. This Fake Block marks a false wall. Morph into a ball and hop up to reach the hidden tunnel.

TIP

You can test a wall for hidden passages by firing a beam or missile. The shot will continue past a false wall.



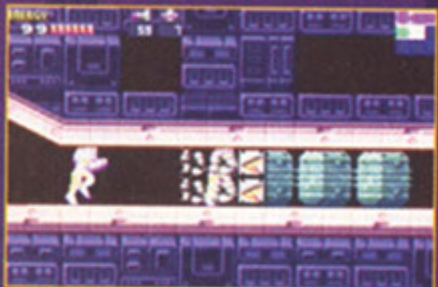
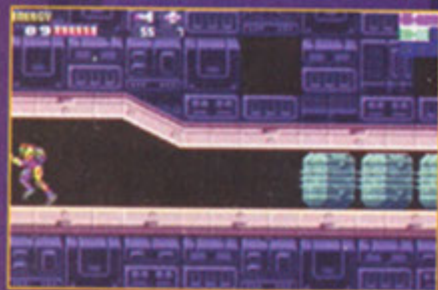

When you make it through the gauntlet of Alcoon and Zeros, you reach a dead end, which includes hidden Power Boost blocks. Return to the tunnel, clear the Zeros from the floor, and race back to the right to blast through the wall.



Place a Power Bomb and blow an opening in the tunnel. Climb up to the ledge and walk to the left to recover a Missile Tank.

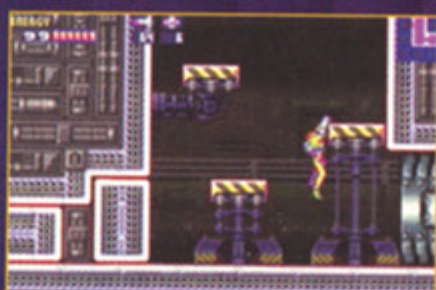

Blast through the opening in the ceiling and hop up to reach the Main Deck. Continue to the right to reach the Docking Bays. Jump all the way down to the floor and exit to the right. Go through the next hallway to reach the bays and Samus's ship. Stand beneath the ship to activate the Save Game feature and receive a new objective.

Objective

The main silo of the Reactor Core has gone offline. That's why all elevators and station systems are down. Elevators and hatches won't work. This doesn't bode well.... If you can get to this point, you may be able to start the auxiliary power system. Then we can figure out why the main silo went offline.... By the way, I asked you to return here to tell you.... Some strange creatures have boarded your ship. I confirmed that they were not X hosts and gave them a berth. Do you know anything about these strange creatures? Were they the source of the healthy bio-signs earlier? Very well, then. Their presence in the midst of this disaster must have some significance.... I will keep them here.

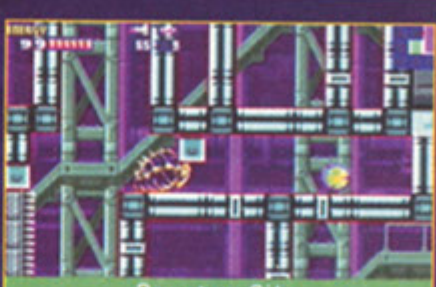
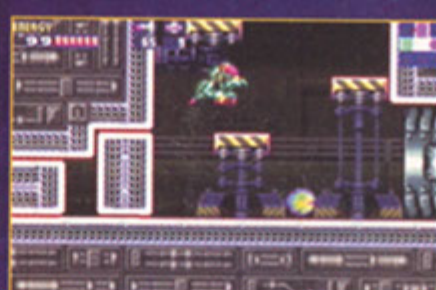

Morph into a ball and roll past the platforms to reach the Reactor Silo. Keep rolling under the skeleton and drop to the next level. Place a few bombs on the right side of the ledge (or you can use a Power Bomb to expose all openings) to open the floor.



Drop two levels and run through the doorway to reach the Central Reactor Core. Somersault off the ledge and press the right Control Pad button → to move sideways as you fall. Grab onto the ledge, then jump up to the ladder on the right. Climb up to the top and go through the doorway.



As you move to the right, a Space Pirate opens fire with energy beams. It crouches after each shot, so if you time your Charge Beams to connect when the Space Pirate stands up, you can defeat it from afar. Hop up to the next ledge and walk down the stairs to meet another Space Pirate.



Continue to the right and jump up to an open tunnel to collect an Energy Tank. Walk to the right and place a bomb near the pillar to open a hole in the floor. Unlike the previous two enemies, the remaining Space Pirates on this level are more elusive and aggressive.

TIP

Do not miss any of the energy or weapons upgrades on this level; the upcoming boss battle will stretch your resources.



Drop down, advance to the left, and get ready for another Space Pirate. You see the energy beams first, so get ready to crouch or jump to avoid being hit. Take out the Space Pirate, walk to the left, and place another bomb near, but not next to, the pillar (see the picture for the exact location).

TIP

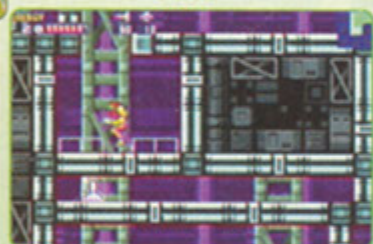

If you used a Power Bomb earlier, you'll be able to drop down two levels, but this is a dead end. However, note the location of the Missile Tank upgrade below the floor. After you defeat the Space Pirate described next, place bombs to the right of the Missile Tank to provide access (you'll need to morph, jump, and roll to the Missile Tank).

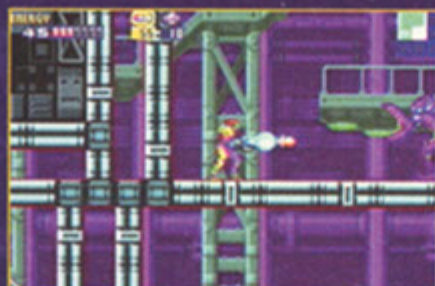
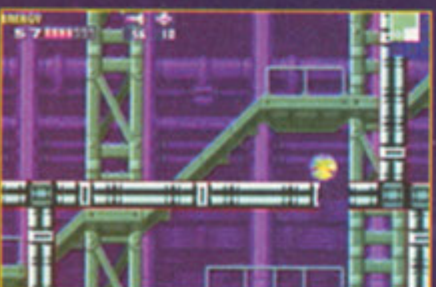

Drop one level and go to the right to meet another Space Pirate. Place a few bombs near the pillar on the right to open another hole. You'll drop down on top of another Space Pirate, so make sure you come up firing. Place bombs near the pillar on the left to open a hole.

TIP

The Missile Tank upgrade described in the preceding Tip is located to the left. Place bombs next to the pillars to open a path to the left. Roll all the way to the Missile Tank.

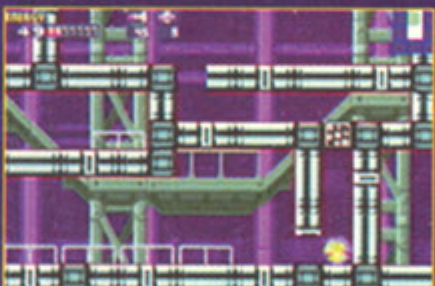

Drop through the hole to face one more Space Pirate. Another bomb provides access to a narrow channel. Roll to the right to find a collapsible Pit Block, which drops Samus down again.

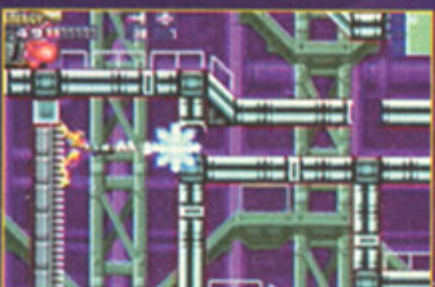

Walk to the left, climb to the top of the ladder, and shoot the wall directly to Samus's right to create an opening. Leap across to the opening, roll right, and then pop up through the hole.



A giant eye guards the hatch to the left. Just as with all the giant eyes in *Metroid Fusion*, avoid the energy beams while waiting for the black dot to appear in the eye. Fire a single missile to destroy the eye. **Important:** You must quickly grab the red X released after the eye disappears. This gives you a full recharge, which you need before the upcoming battle with Spider Boss.



After dispatching the eye, move through the hatch and jump off the ledge. As you fall, move back

and forth, then run to the far-right corner of the room. After you hear loud noises, a shower of fireballs rains down, followed by the arrival of Spider Boss, a giant spider. Try to avoid the fireballs, but don't panic if Samus is hit. The fireballs won't kill her, but Spider Boss will. Watch the giant spider as it bounces off the side walls. Move quickly to relocate Samus away from the spot the spider will hit when it reaches the ground. We suggest staying in morph ball to roll quickly from side to side during the first few landings.



Spider Boss continues bouncing off the walls, going up and down in the room. Don't waste any shots while the spider moves. You can hurt Spider Boss only when its mouth opens and red jaws protrude straight down. Run under Spider Boss and fire missiles straight up into the jaws. Every accurate shot turns Spider Boss white, so you'll know when the spider is receiving damage. Depending on how quickly you position Samus under Spider Boss, you can get up to four or five hits before the spider starts moving again.

CAUTION

When Yakuza's jaws recede, the spider is very close to the floor, so Samus is in danger of being snapped up. If Yakuza grabs Samus, hit the left and right buttons on the Control Pad, ← and →, repeatedly to shake loose.



When Spider Boss turns blue and its eyes turn green, the spider is close to the end of its first incarnation. Eventually, Spider Boss explodes and loses its legs, but what remains is even more powerful than the whole spider.



Spider Boss's blue head spins wildly as it launches powerful blasts at Samus. At this point, you must move to the far-left corner of the room. The time for running is over. Your only hope is to stay in the corner and fire at the head when you have a shot. Your shots can also deflect Spider Boss's attacks. When Spider Boss's head turns red, it is close to the end, but there is one more form to go.



When the head explodes, several X are released, and a Beam Core-X remains. Try to grab the floating X to give Samus a boost for the final battle.



Continue firing missiles while avoiding the Core-X and collecting the floating X. When you finally break the shell, the X cluster is released. Jump up and grab it to regain Samus's Space Jump ability.

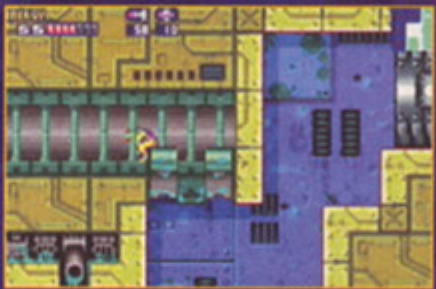

You'll put Samus's new ability to use immediately, because it is your only way to leave this room. The Space Jump is really a series of consecutive Spin (somersault) jumps. By rapidly executing the Spin Jumps, you can keep Samus

in the air. As you jump from one direction to the other, Samus hovers in the air and gradually climbs with each jump. After a little practice, direct Samus up to the ceiling across from the doorway. "Fly" up into the opening to reach the tunnel.



Walk to the left to reach the Auxiliary Power Station. Step on the pressure pad to engage the auxiliary power. Exit to the left to reach the Navigation Room, where Samus receives a new objective.



Sector 2 (TRO)

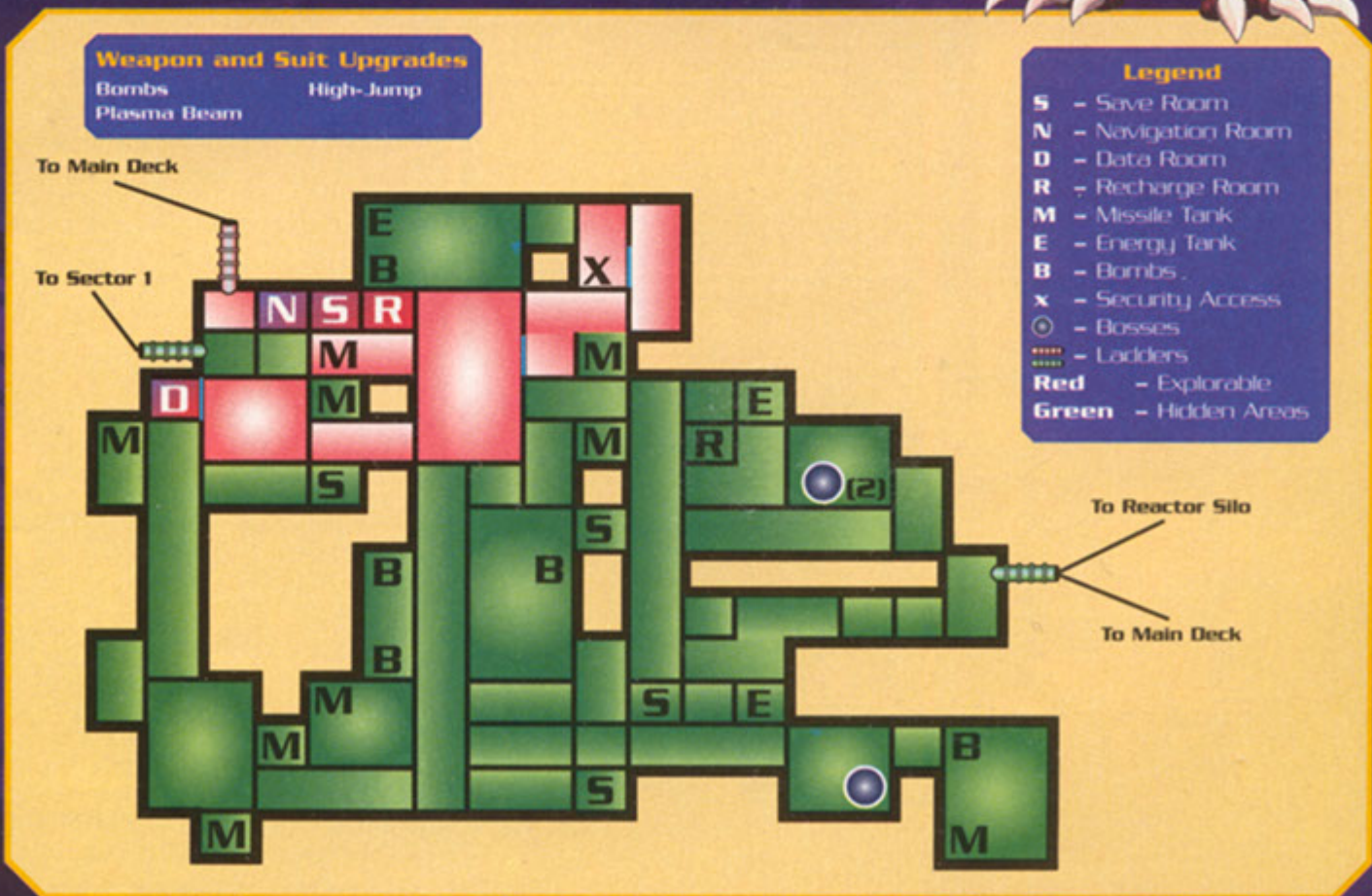

Objective

Save Rooms and Recharge Rooms are now back online, but with only auxiliary power, no elevators or hatches will work. Without the main silo online, we're still stuck. I believe the source of the problem is the vegetation you saw earlier choking the Reactor Core components. We'll have to find the source of those roots to proceed.



Exit to the left and raise the shutter to proceed through the next door and reenter the Central Reactor Core. A swarm of Kihunters attack. Drop to the bottom, shooting the Kihunters as you go, but be careful not to become tangled in the vegetation. Exit through the door on the right to reach the Save Room (you really don't want to fight Spider Boss again, do you?)



Use Space Jump to fly up the left side of the reactor. Hug the wall and continue going up until you reach a tunnel on the left.

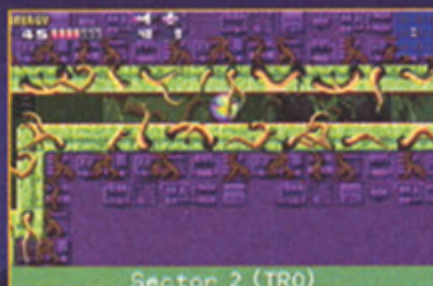
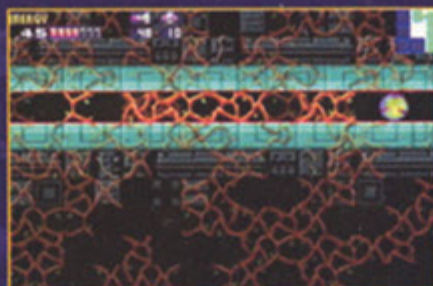

Sector 2 (TR0)

Roll to the left until you reach the tangled vegetation. Set off bombs to clear the path as you go, or use a single Power Bomb to open the tunnel. Keep rolling to enter Sector 2.

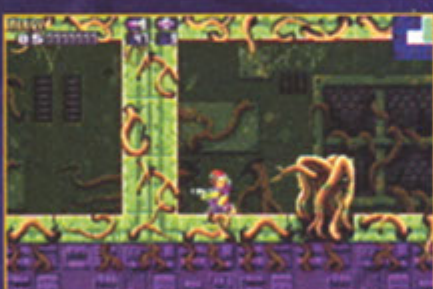

Samus falls through Pit Blocks to the floor and immediately encounters the SA-X. Fire an Ice Missile, jump over the temporarily frozen SA-X, and continue through the door. Now you must move quickly if you want to survive. When you reach the next room, leap over the roots and set off a Power Bomb to clear the room. As you can see, the SA-X is right behind you.



Keep running through the next doorway and shoot the ceiling lights to open the three shutters. Just keep firing while running, because you don't have time to stop, aim, and shoot at each one.



Leap over the roots and run through the door. In the next room, jump to the top of the barrier and place a Power Bomb. The explosion reveals a tunnel in the ceiling. The SA-X can't see Samus on the barrier, so you're home free. Jump up and roll to the right.



Roll to the right and drop down through the Pit Block. The SA-X is gone for now, so you can return to the previous room. Jump up in the air and aim missiles down to blast through the floor to the next level. Continue down and exit through the door on the left.



Use Space Jump to elevate Samus to the ledge, then set off a Power Bomb to clear the vegetation. Drop into the opening just left of the ledge and continue out the door to the left.





Run through the short corridor and work your way up and over the barrier in the next room. Use Space Jump to fly up, over, and around the large barrier in the center of the room. Jump against the left side of the barrier to crumble the Pit Blocks and create an opening. Blast through the wall to the right and shoot the flying and bouncing Puyo.



Continue to the right to reach a Power Bomb Tank. Go back to the left and fly Samus up to the top level. Run through the door to reach a Save Room. Exit to the right to return to the jungle room.



Use Space Jump to fly up to the next ledge. The wall to the right is fake, so morph into a ball and roll through the wall to reach a Recharge Room.

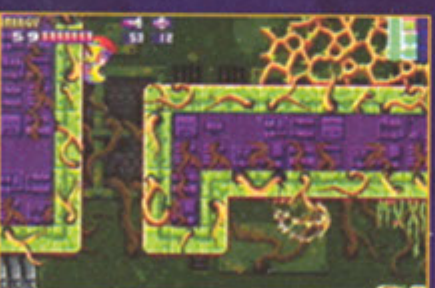

Roll back to the jungle room and jump down through the vegetation (you can use bombs or simply fire missiles downward as you drop). When you reach the bottom, exit through the right-hand door to reach another jungle room. Shoot the ceiling to clear a path upward, then fly to the next level.



Blast through more vegetation and more Kihunters to reach the right-hand wall. Shoot up through the ceiling to create an opening. Spin up through the opening to reach a giant eye guarding the hatch on the right.



Go through the door to face a giant plant boss that is responsible for fouling the Reactor Core. When you drop into the room, Samus falls into plants on the floor. Climb up to the pillar as quickly as possible, because the plants will try to hold Samus down. Meanwhile, the spore shooters on the ceiling fire spores at Samus, trying to knock her off the pillar. If you respond quickly to each impact,

directing Samus back to the pillar, you can maintain your attack against the massive plant to the right. Continue firing Ice Missiles at the giant plant while avoiding the spore shooters. Eventually, the front of the plant falls away, and it begins shooting triple beams at Samus. Jump to avoid the beams and continue firing at the boss.

TIP

The giant plant shoots high and low, so you must jump or crouch accordingly to avoid being hit.



It takes a bushel of missiles to defeat the giant plant, so be patient. If you run out of missiles, use Charge Beams, but be especially careful to avoid its beams while you charge up for the next shot. Your persistent attack finally destroys it, releasing a Core-X. This is a beam Core-X that shoots back, so you must continue jumping back and forth over the Core-X as you aim missiles at the eye. When your attack destroys the Core-X, jump and grab the green X to regain Samus's Plasma Beam ability. Now, Samus's beam attack penetrates enemies, damaging multiple targets.



Exit through the white hatch to the right and use your new Plasma Beam to shoot through the wall directly across from the hatch. After eliminating the Kihunters, drop to the next ledge and repeat the process. Clear one more pocket of Kihunters, then exit through the white hatch on the left.



Run through the jungle room, blasting anything in your path. In the next room, drop down through the opening and fight your way to the door on the lower left.



Run through the short corridor and into the next room. Jump over the barriers, continue to the left, and then fly up and over the large square structure in the center of the room. Run through the door on the right.



Stop in the Save Room, then continue to the right. Shoot a swarm of Kihunters and Space Jump your way up the vertical chamber. Watch out for the Side Hoppers as you move toward the ledge on the right. Morph into a ball and roll into the Recharge Room behind the fake wall on the right. Return to the previous room, climb up one more level, and exit to the right.

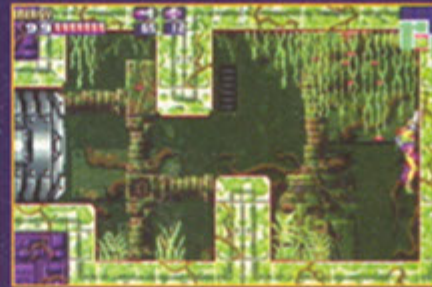

Clear the room of Owtsch, then jump up to the hidden opening midway up the right-hand wall. Continue into the next room, jump up into the opening on the right, and fire to the left to expose a hidden Energy Tank.



Go back to the left and drop through the vertical chamber, exiting through the door on the left to reach the Save Room. After saving your hard-earned game file, go left and drop all the way down the next room to the door on the lower left.



In the green room, fly up to the white hatch on the left. Go through the hatch to find a valuable Power Bomb Tank. This is a tricky one, because the series of ledges on the left consist of Pit Blocks that crumble under Samus's weight. Hang on the left side of the ceiling rungs and time your drop to bounce off one of the Rippers. Immediately tap the + Control Pad rapidly to use Space Jump, flying left and up to the Power Bomb Tank. You'll earn this upgrade.



After collecting the tank, drop through the wall until you reach a sticking point. Place another Power Bomb to reveal another hidden Power Bomb Tank. After the explosion, Samus continues her descent. Roll out to the right and climb up the ladder to leave the room through the white hatch on the right. From here, go straight up the map to reach the Recharge Room on the left. Stop and fill up your recently expanded energy and weapons capacity, and continue through the Save Room to reach the Navigation Room. Samus's new objective requires a return trip to Sector 5.

Sector 5 (ARC)

Weapon and Suit Upgrades

Ice Missiles
Gravity Suit
Super Bomb

Legend

- S** - Save Room
- N** - Navigation Room
- D** - Data Room
- R** - Recharge Room
- M** - Missile Tank
- E** - Energy Tank
- B** - Bombs
- X** - Security Access
- ⊙ - Bosses
- - Ladders
- Red** - Explorable
- Green** - Hidden Areas

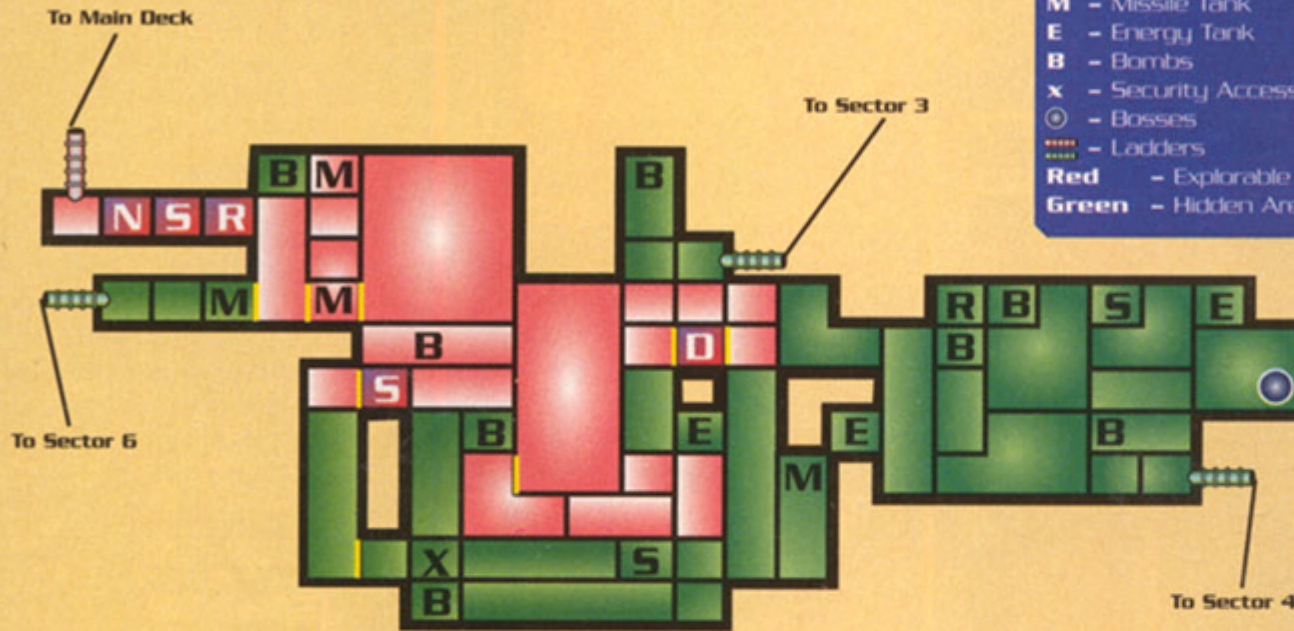

Shoot the creature on the ceiling, then set off a Power Bomb to create an opening to the left of the Missile Tank. Jump up to grab it and continue to the right.



Use Space Jump to fly up through the narrow opening. Shoot the Choot with an Ice Missile, then use it as a stepping stone to reach the next level.



Objective

What? You've restored Plasma Beam functionality...? Most unexpected. Even so, continue to avoid the SA-X. It, too, may be stronger. And you still lack a few abilities crucial to survival.... Wait.... Wait a second.... More trouble. Hold on.... I've isolated the cause. There's been an explosion in the ARC Data Room.... Samus, go to Sector 5. The damage is staggering. Find out what's causing it.

Exit to the left, take the elevator back to the Main Deck, and then take the elevator down to Sector 5. Stop in the Navigation Room for further instructions.

Objective

It's gotten worse. The damage seems to have been caused by a creature kept here by the researchers, who named it...the Nightmare. Apparently, it was a bio-mechanical organism designed for military applications.... It possesses uncommon power and can manipulate gravity. We must assume that it's become an X host. We have no choice. You must find it and defeat it. I can't confirm the location. This thing is out of control. Hurry before it destroys the entire station....



Continue to the right, through the Save and Recharge Rooms, and enter a vertical chamber filled with Bulls. Drop straight down, firing as you go, and exit through the yellow hatch on the right.

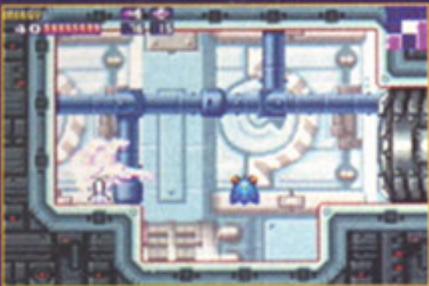
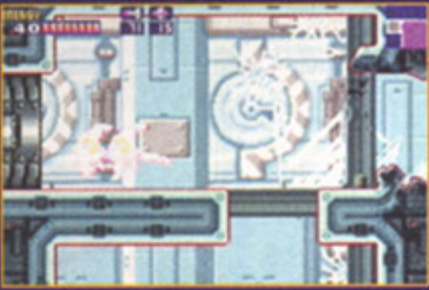

Shoot the white hatch to the left to open the door, but do not go in. Instead, go to the right, past the wreckage and rubble until you reach the far wall. Turn around and run back to the ledge. As Samus approaches the ledge, Speed Booster kicks in. To prevent Samus from dropping down, immediately press the Down Control Pad before Samus reaches the opening. This maneuver temporarily suspends Samus in the air, giving you a second or two to resume the Speed Booster. Now, tap the Left Control Pad to continue to the left at super speed. Samus zooms into the room and collects a Missile Tank.

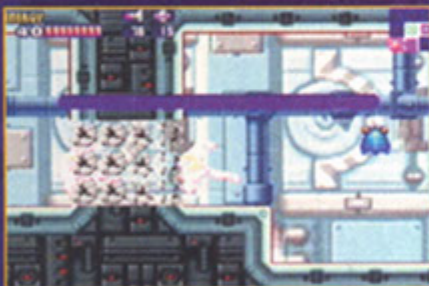

But, wait, there's more! Samus's Speed Booster takes her through the wall into the next room. After slamming into the wall, jump up to the short ledge to collect a Power Bomb Tank.

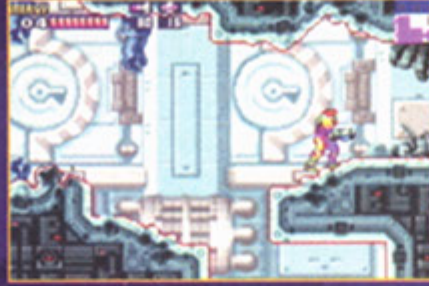
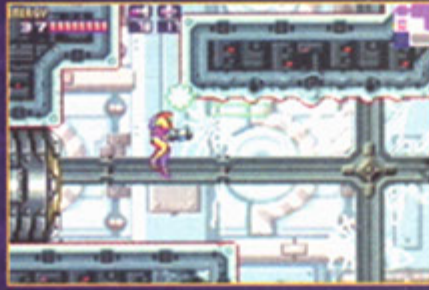

Go back to the right and drop all the way down to the yellow hatch on the left. Run to the right and go through two damaged doors.

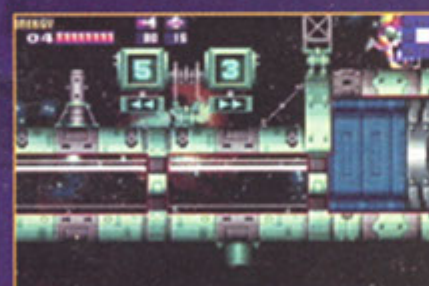

Set off a Power Bomb in the short corridor to reveal an opening overhead. Jump up to the ledge and exit to the right, taking the tunnel to Sector 3. Stop just before the door and place a Power Bomb to reveal a hidden Power Bomb Tank in the ceiling.



Go back to Sector 5, jump down into the depression, and fire a missile to open the floor. Continue to the right, across the opening.



Shoot the Bulls on the floor and the Gerubus on the ceiling. Continue down the ramp to the right, and out through the damaged door.



Set off a Power Bomb to expose Pit Blocks on the floor, and Screw Attack Blocks on the left. You don't have Screw Attack just yet, so for now, drop down through the Pit Blocks into the water. When you reach the bottom, shoot the Kihunter. Your Space Jump ability doesn't work in the water, so you need to use the Skultera for stepping stones. Freeze one, then the other, and climb up close enough to reach the indentation on the right.

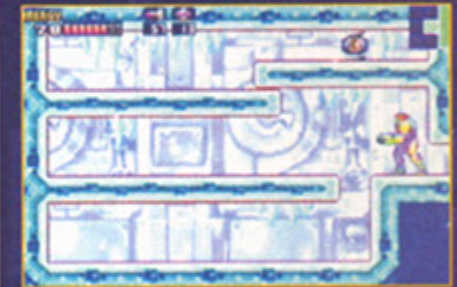

Look to the left and fire an Ice Missile to create a matching indentation in the left-hand wall. Somersault up to the opening and roll into the room, where you'll find an Energy Tank.



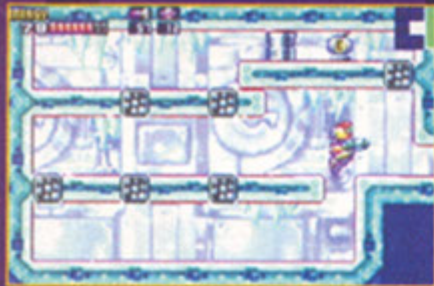

Explode a Power Bomb to reveal Pit Blocks, and a pillar, all designed to keep Samus from reaching the Energy Tank. Now that you know the locations, leave the room, and return to restore everything to the original condition.

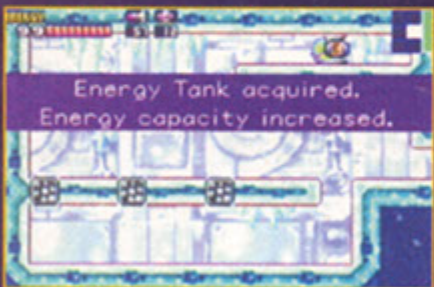

Jump to the left, past the first two Pit Blocks. There is a false floor directly above Samus, so you can jump up to the next level. Walk to the right, grabbing onto the ledge each time you fall through a Pit Block. Jump up to the high ledge, morph into a ball, and roll to the Energy Tank.



Drop back down to the bottom of the tank and exit through the white hatch to reach another water tank. Shoot the Kihunters and walk to the far right. Another Kihunter blocks your way to the ledge. Shoot it, climb up, and work your way back to the white hatch on the left.



Climb up the short ledges on the left, jump over to the right, and exit through the white hatch. Shoot the Gerubus on the ceiling and set off a Power Bomb to blow a hole in the ceiling. Climb up and walk to the left, entering a small room filled with Bulls. Use a Power Bomb to clear the room, except for a Gerubus hiding behind the left-hand wall. Use

missiles to destroy it, pick up the red X, and then drop down to grab the Power Bomb Tank in the left-hand corner of the room.



Exit the room to the right and jump up to reach the white hatch. Set off a Power Bomb to expose a tunnel on the upper left-hand wall. Roll to the left and exit through the white hatch to enter a Recharge Room.



Go back through the hatch, jump up to the small opening, and place a Power Bomb to restore the tunnel. Roll a short distance to the right, jump up, and roll left to collect a Power Bomb Tank. Roll back to the right, drop down, and exit through the white hatch to reach a Save Room.



Exit the Save Room, drop off the ledge, and go right, through the door. Set off a Power Bomb to clear the herd of Bulls from the room, then use Space Jump to fly up to the ledge on the right, where you'll find a giant eye.



Shoot the giant eye, collect the red X, and proceed through the hatch to find an Energy Tank, but don't go rushing in just yet. Set off a Power Bomb to reveal a hidden Pit Block trap. Jump up to the high tunnel and roll over to collect the Energy Tank. Then roll left and drop through the Pit Blocks to meet your worst Nightmare.



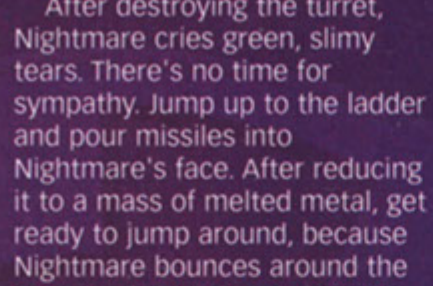

Samus drops into what appears to be an electronic junkyard. Stay on the left side of the room as Nightmare rises up from the floor on the right. Your first task is to shoot Nightmare's turret, which is tucked up between two metal arms. To get a better angle on the turret, move over to the right as the creature rises. Use the Plasma Beam or Ice Missiles to get in a few hits before Nightmare floats back down. While you are maneuvering for a good shot, watch out for Nightmare's energy beams, which fire from both arms.



Keep firing until Nightmare explodes, leaving a Core-X. Avoid the bouncing ball and shoot

missiles to rupture the Core-X skin. Grab the free X when you can, and keep up a steady attack until the Core-X disintegrates, leaving an X cluster. Jump up and grab the floating X to recover Samus's Gravity Suit effect. Now Samus can move and jump at full speed in water.

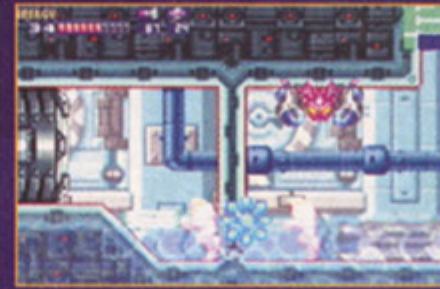

Run to the left to trigger Power Booster and run into the next room, smashing through the wall. Clear the Gerubus from the next room and continue to the left, dropping into the water. Exit through the hatch on the lower right.



Continue to the right, moving down the ledges to reach a white hatch. Run all the way to the left, clearing a path for a Power Booster run. Run back to the right, penetrating the wall, continuing through a tunnel, and blasting into Sector 4.

TIP

Jump up and use the ladder on the left to avoid Nightmare's energy beams. Be careful not to let Nightmare back Samus into a corner, where she is vulnerable to repeated hits.



Sector 4 (AQA)

Weapon and Suit Upgrades

Speed Boost Diffusion Miss.

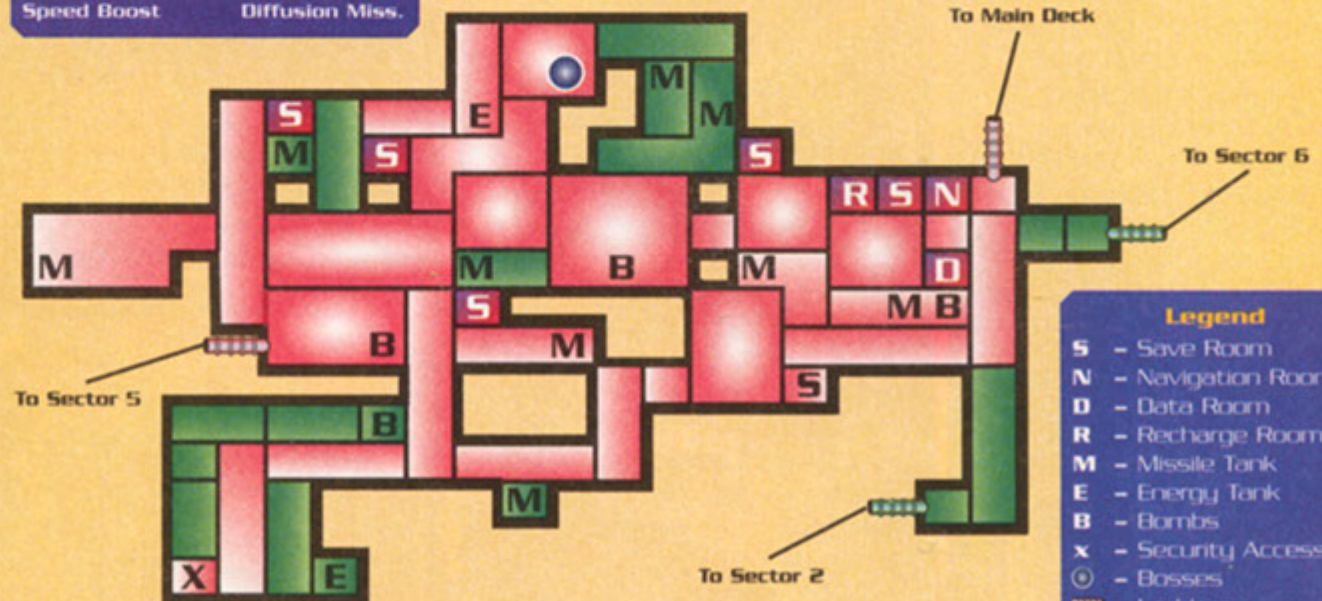

Legend

- S - Save Room
- N - Navigation Room
- D - Data Room
- R - Recharge Room
- M - Missile Tank
- E - Energy Tank
- B - Bombs
- X - Security Access
- ⊙ - Bosses
- - Ladders
- Red - Explorable
- Green - Hidden Areas

NOTE

The Navigation Room computer does not provide a new objective on this level. You must explore Sector 4, unlock the Level 4 (red) hatches, and acquire the Diffusion Missile upgrade.



When you reach Sector 4, turn around and run back the way you came. Watch carefully. When Samus blasts through the first wall, hit + Control Pad ↓ to pause the Speed Booster. Then press + Control Pad ↑ to continue the Speed Booster vertically until Samus powers into another room. Pick up the Power Bomb Tank to the left.

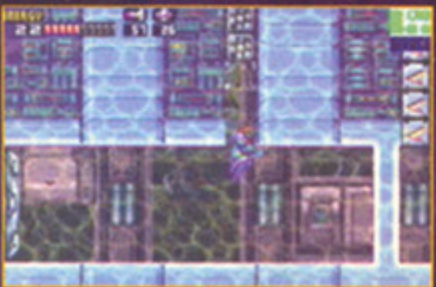

Walk to the left and drop through the Pit Blocks. Go all the way back to the left, clearing the room in Sector 5, so you can repeat the Speed Booster back into Sector 4. This time, hit + Control Pad ↓ when Samus reaches the top of the ramp. Hit Ⓐ to lift Samus's feet, and finally hit + Control Pad → to continue the Speed Booster on an upward angle toward the Boost Blocks.



Continue through the white hatch, hop over to the open door, and enter the Save Room to store your game file (you want to protect all of the recently acquired upgrades, not to mention your victory over Nightmare). Leave the Save Room and drop down, exiting through the white hatch to the right.



Shoot the stacks of breakaway blocks as you move through the room. Continue to the far right and shoot through the breakaway blocks in the corner of the room to reach a Missile Tank.



Exit to the left and set off a Power Bomb on the ledge. Jump across to the left-hand wall, morph into a ball, and jump up to the hidden tunnel. Roll to the left and collect a Power Bomb Tank.

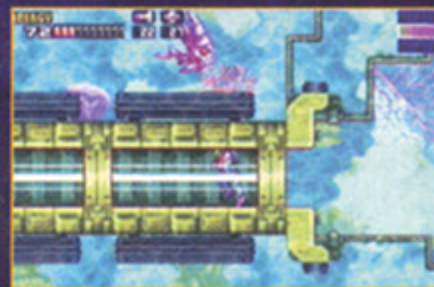

Return to the vertical chamber and drop all the way to the floor. Exit to the left, shoot the Skultera, and hop up into the clear tunnel to the left. Set a Power Bomb while inside the tunnel, to expose a series of Missile Blocks overhead. Shoot through the blocks and jump up out of the tunnel.



Go to the right and follow the path up through the thin barriers. Set a Power Bomb to open a pathway up and to the right. Roll to the right to find another Power Bomb Tank.



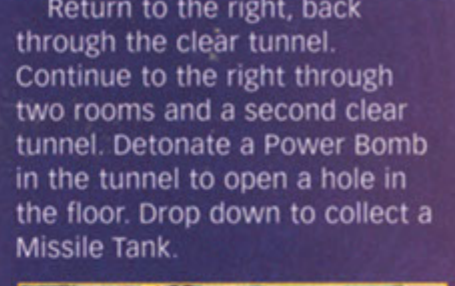

Follow the path to the left and place another Power Bomb on the ground. Scoop up the floating X and drop down through the opening.

Step on the pressure pad to unlock the Security Level 4 (Red) hatches. Exit to the right through the red hatch. Spin up through the vertical room and detonate a Power Bomb on the right-hand ledge. Morph into a ball, jump up, and roll through the tube to the next room.

The next room is another maze of thin walls and blocks. Set off a Power Bomb to remove the blocks, roll up and over to pick up the Energy Tank, and exit the room to the left.

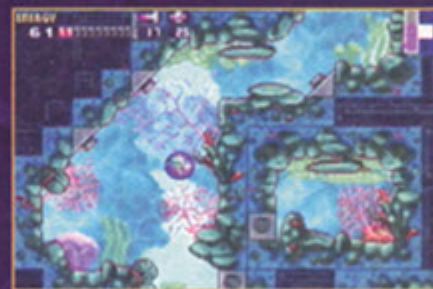

Shoot away the blocks and jump up, working your way back to the hidden tube where you first arrived. Roll to the left to return to the ledge. Use Space Jump to fly up, and exit through the red hatch on the right.

Shoot the Kihunter and several Skultera, then spin back up to the opening. Continue to the right until you reach a room with what looks like a giant shrimp. Set off a Power Bomb to clear the room, then spin up to the red hatch on the right.

Place a bomb to open a hole and continue your descent. Look for false walls as you drop, and use bombs to clear the path, as you work your way back and forth through the maze. One more bomb on the floor opens a tube to the Security Room below.

Work your way down to the floor and use a Power Bomb to blow away the barriers. After the explosion, jump up and down while firing missiles until you destroy the Missile Blocks to the right, opening a path to two golden crabs. Shoot the crabs, then drop down to exit through the white hatch.

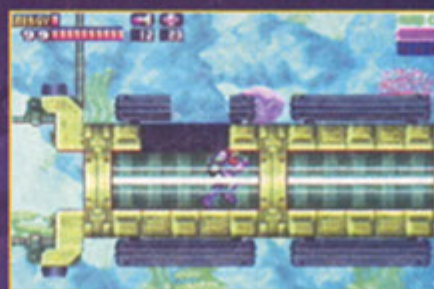



Continue to the right through the short tube, then place a Power Bomb in the next room. Work your way to the right and exit through the white hatch to reach a Save Room.



Return to the previous room and work your way up to the ledge that is guarded by a seemingly innocent little bump. But, the only way to get past is to freeze it, and then roll up and over. Shoot the snail on the ceiling, then run through the white hatch and the following door to reach a small room.



Turn around and run back to the left, gathering enough momentum to initiate Speed Booster. When Samus runs over the Boost Blocks, she falls down into the next room. Go through the white hatch on the right and run through the next room. When Samus zooms to the next hatch, hit + Control Pad ↓ to pause Speed Booster. Jump up through the ceiling and into the next room, where you find a Power Bomb Tank. Drop back through the floor and exit to the right.



Use Space Jump to fly up to the short ladder at the top-right corner of the room. Freeze an inflatable bomb when it rests just below the ladder and use it for a stepping stone as you fire a missile to open a hole in the ceiling. Climb up, morph, and roll to the white hatch.

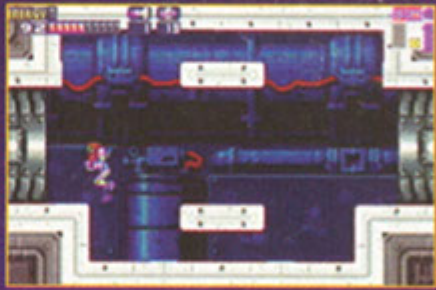
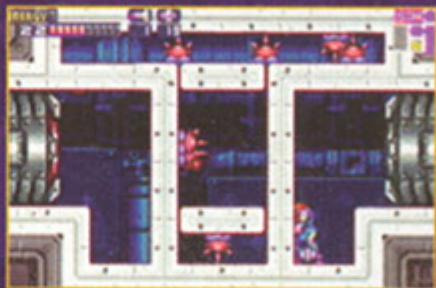

Set off a Power Bomb in the next room, pulverizing the Owtsch and clearing the barriers. Go through the door on the left.

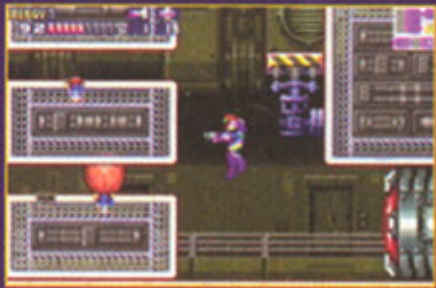

Drop to the floor and exit through the red hatch to reach the Data Room. Step onto the pressure pad to acquire Diffusion Missile. This ability allows Samus to charge up an Ice Missile blast, which then hits all enemies within a certain radius.

TIP
If your resources are low, return to the small room filled with Owtsch. Harvest the X, then go back and forth into the room, filling up Samus's weapons and energy.

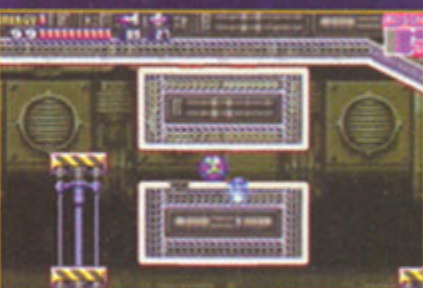

Backtrack through the red hatch and hop up to the yellow platform. Use your new Diffusion Missile to freeze *all* of the inflatable bombs on the platforms to the left. While they are frozen in their small forms, jump over, morph, and roll past the top one. Go through the hatch and continue to the left.



Use the platforms to jump up and over to the white hatch on the right. Stop in the Recharge and Save Rooms, and continue to the Navigation Room for Samus's new objective.

Sector 6 (NOC)

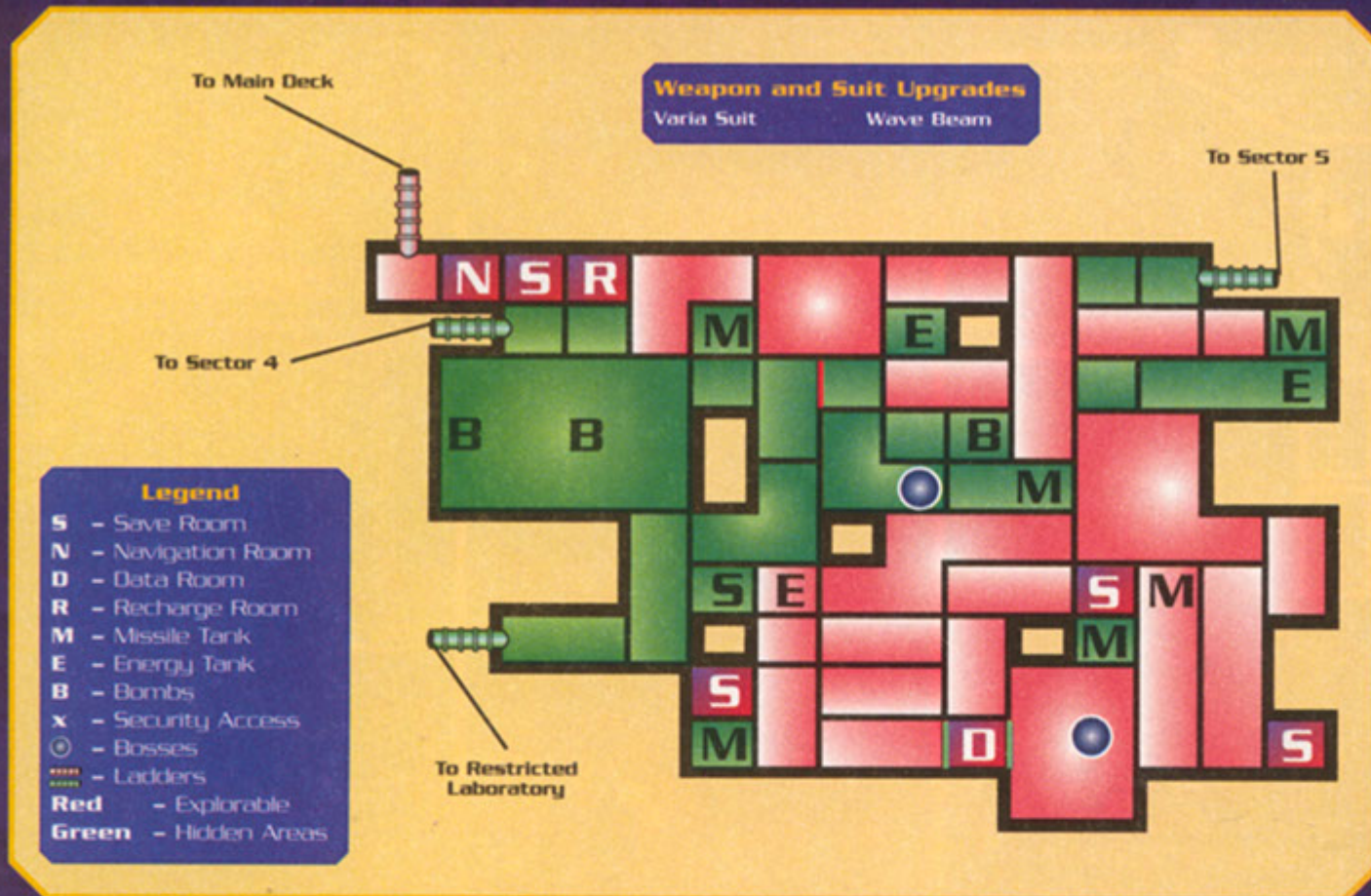

Objective

You upgraded your missiles? That's unusual.... There was no word from HQ. A procedural error, I'm sure.... Even so, I did not approve of bypassing security level 4. From now on you will use more discretion. In any case, Samus, do you remember the Security Robot you faced earlier? I believe the X have infected it. That is to say, they have claimed the organic components that form its neural network. It has entered Sector 6 (NOC). I don't know what it's planning, but let's not wait to find out. Samus, you know what to do. To Sector 6, quickly.

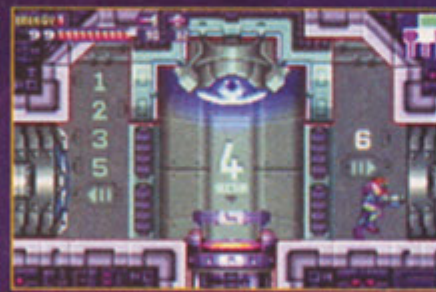

Exit to the right and take the elevator back to the Main Deck. Go right to reach the Sector 6 elevator. When you reach Sector 6, exit to the right and stop at the Navigation Room for an update.

Objective

The Security Robot seems to have gotten much stronger. This worries me. Be careful. But we have another problem. Once you're done, leave NOC immediately. The SA-X is tracking you. Don't stay longer than you must, understand?

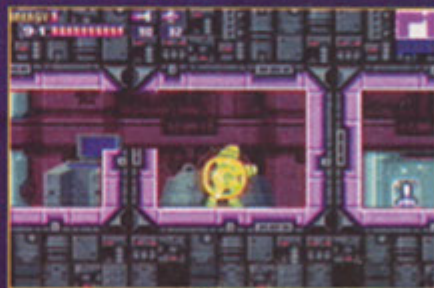

Exit to the right and drop to the lower level. Shoot through the barrier and continue to the right. Note the Missile Tank on the other side of the wall: Turn around and jump back up to the ledge, but this time go to the right, up the ramp, and out the door.



Drop to the lower level and clear the room of enemies. Morph into a ball and jump up alongside the left-hand wall, leaving bombs. After the explosions, jump up into the opening and roll to the left.

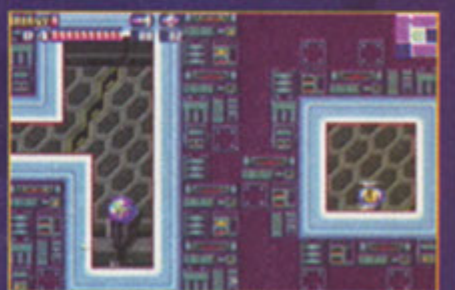

Pick up the Missile Tank and roll back to the previous room. Continue to the right and place two more bombs alongside the right-hand wall to open another tunnel. Roll to the right and drop into a small room.



Set off a Power Bomb to open three tunnels to the right. Enter the top one and roll over to the Energy Tank. Collect the upgrade, then backtrack to the previous room. Jump up to the next ledge and follow the path back around to the right and out the door.



Run through the room and out the white hatch. Follow the path down and exit through the first white hatch on the right.

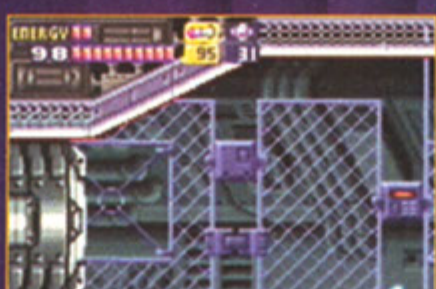

Plow through the room, going up, over, and through the barriers (use your Plasma Beam). Go through the door to what appears to be a Missile Tank. As you approach the upgrade, it suddenly flies away. Shoot the decoy and place two bombs on the floor to open a hole through the barrier. Collect the real Missile Tank in the next room.



Return to the previous room, shoot your way through the barriers again, and go out the door. Drop one level and exit through the white hatch.



Go over the short barrier and place a Power Bomb in the far-left corner. Continue to the left and exit through the door.

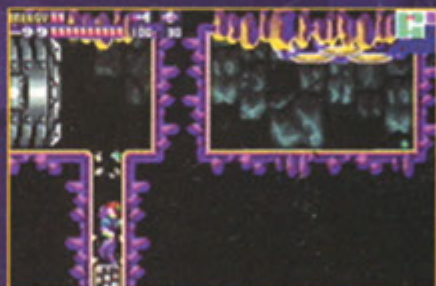

Clear the Owtsch from the top ledge, jump down, and exit through the door below. Samus drops through the Pit Blocks to a water room. Turn around and go through the white hatch.



Shoot the Bulls, run down the rock incline, and shoot more Bulls below. Exit to the left and wipe out the Owtsch before dropping down off the ledge. Exit to the right and make a quick stop in the Save Room.



Leave the Save Room and walk to the left-hand wall. Jump up and fire Plasma Beams straight down to blast through the floor. Exit through the red hatch.





up the rock ramp and through the white hatch to reach the water room again. This time, the waters are anything but calm as the Security Robot charges. Jump back up to the top step and set off a Power Bomb to expose the ceiling rungs. Jump up to the ceiling, avoiding a salvo of missiles, and fire straight down into the top of the robot, its only weak point.



Continue to the left, past a Caution sign, until you trigger the restricted area alarm. That should wake up the Security Robot. Go back through the red hatch, blast a hole in the ceiling, and spin back up. This time, go all the way up to the top level and exit through the white hatch.



As you go through the door, the walls start shaking and you hear the warning again. Go back

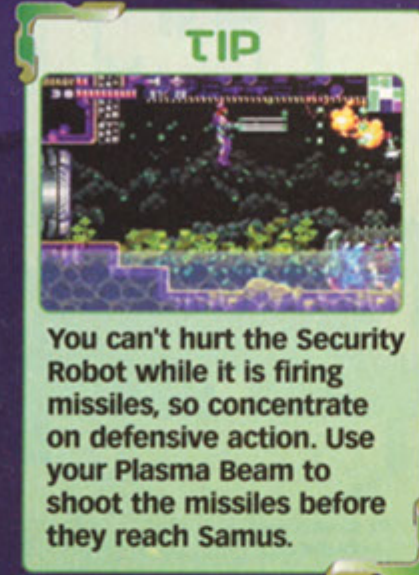

Keep moving back and forth along the ceiling and firing at the Security Robot (the left side is the best place to be when the robot starts firing missiles). Be patient; it takes about 50 missiles to destroy the robot. When the robot explodes, a Beam Core-X

remains, so the battle is not over. Jump back and forth over the Core-X, avoiding the energy beams while you fire at the shell. When the X cluster is released, grab it to restore Samus's Wave Beam ability. Now, your beam attacks can penetrate walls.

CAUTION

The Wave Beam fires through all objects, so it is no longer capable of finding false walls.



Exit to the right and use your new Wave Beam to fire through the shutter and hit the red light on the other side. Collect the Missile Tank. Exit the room to the left and backtrack through the water room. Go down the rock ramp, continue to the left, and go out the door.



Go back through the floor and exit to the left. Run through the restricted area and fire through the shutter to open it. Morph into a ball and roll to the left, entering the Restricted Zone.



Exit through the red hatch, stop in the Save Room, and continue to the left, going through another red hatch. Race through the Restricted Laboratory and keep going (you probably shouldn't be here!). Go up the stairs and exit to the right, through the red hatch, to get a glimpse at what is taking place here.



Sector 1 (SRX)

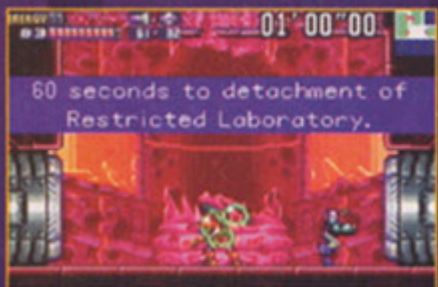

As you retrace your steps, you run past the SA-X, which is destroying the laboratory. As the SA-X absorbs massive amounts of X from the broken containers, you receive notification that the Restricted Laboratory will detach in 60 seconds! There's no time to waste. Use Space Jump to fly up as the explosions intensify.



Fight your way up through the explosions to the second level, then exit to the right. As you disappear through the hatch, the Restricted Laboratory is jettisoned. Run back through the remaining piece of tunnel to reach the Main Deck Navigation Room, where you hope to find out what is going on. And more importantly, who is Samus's true enemy?

Weapon and Suit Upgrades
Charge Beam Screw Attack

- Legend**
- S - Save Room
 - N - Navigation Room
 - D - Data Room
 - R - Recharge Room
 - M - Missile Tank
 - E - Energy Tank
 - B - Bombs
 - X - Security Access
 - ⊙ - Bosses
 - - Ladders
 - Red - Explorable
 - Green - Hidden Areas

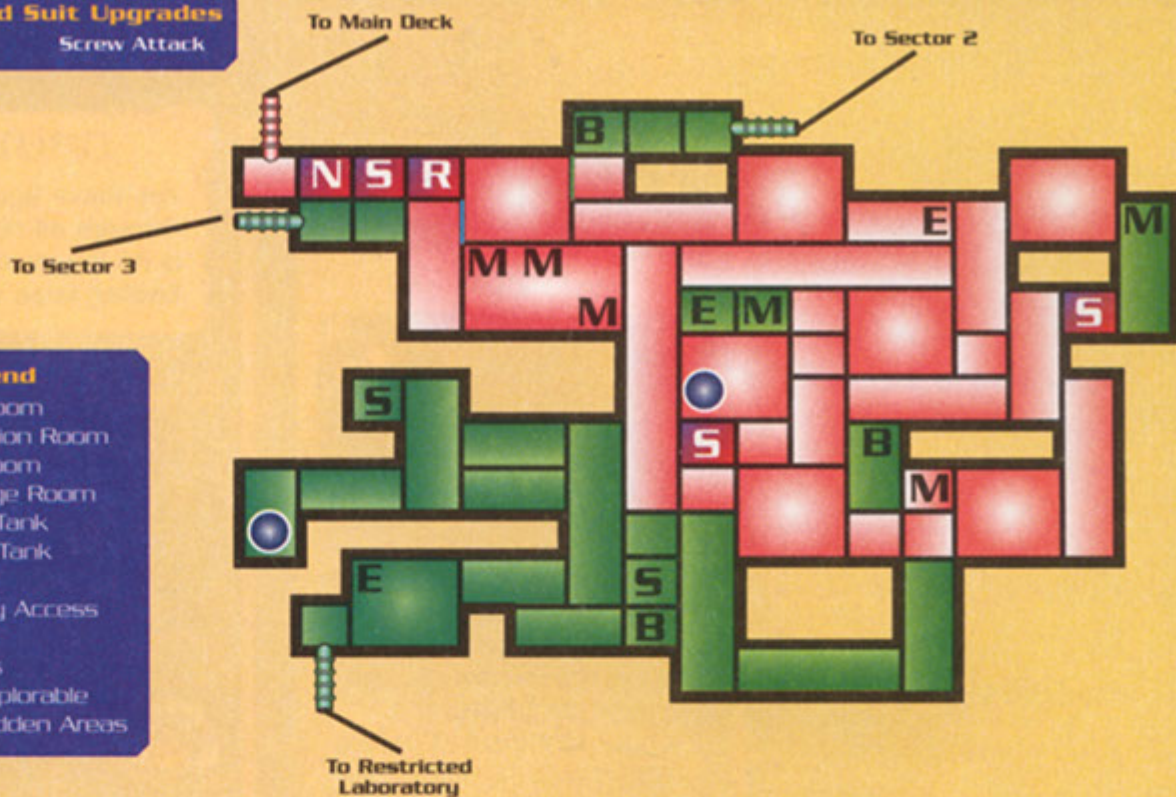

Objective

Samus, you shouldn't have done that. You ignored your orders. You may have to pay a price for that quite soon.... As you can see, the Federation has been secretly working on a Metroid breeding program. For peaceful application only, of course. Please understand. But perhaps you already know of this program's existence? Certainly you must have had doubts when you saw Sector 1. SRX, a faithful replica of the SR-388 ecosystem.... Ideal for raising Alpha, Gamma, Zeta, and even Omega Metroids. This research even uncovered techniques for rapid growth. Imagine...creating an Omega from a larval Metroid in days.... But that research is finished. The X has smelled out its natural enemy, and one of the SA-X is on its way here....

Samus: ONE? Are you saying there is more than one SA-X?

Don't be so surprised, Samus. You know that the X reproduce by asexual division. Because of this mechanism, there are now no fewer than 10 SA-X aboard the station. Samus, you must go. Get out. If you stay too long, the SA-X will destroy you. Stop only at a Navigation Room to uplink to me. I don't know how HQ is going to take this, but you need to report to them immediately.... Now get going.

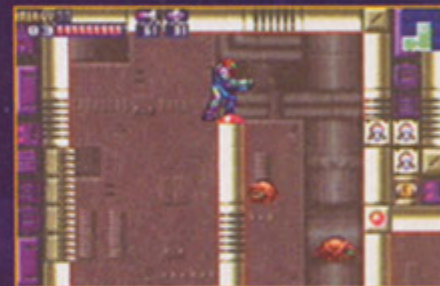

Exit to the right and take the elevator up to Sector 1. Use Space Jump to fly up to the top of the tall pillar. Set off a Power Bomb to reveal the Missile Blocks to the right. Aim a Diffusion Missile at the pillar to the right. The diffusion effect will break the Missile Blocks, creating a path to



the Energy Tank, and it will freeze the Ripper, providing a stepping stone to the opening. Hop onto the Ripper, then jump to the opening. Roll in to pick up the Energy Tank.

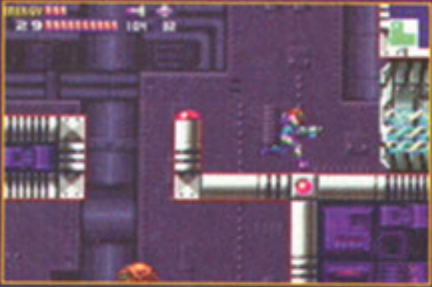

Go back through the opening and drop down. Continue to the right, shoot the Gerubus on the ceiling, and travel up and around the barriers to reach the white hatch in the upper-right corner.

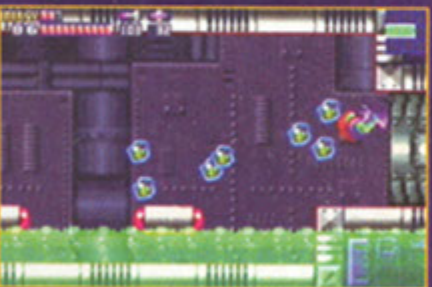
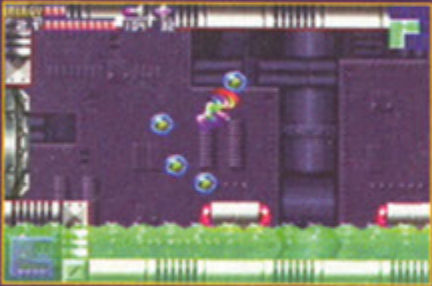

Samus is immediately attacked by Metroids in this room, so move through it as quickly as possible. When you reach the other side of the room, turn and fill the air with Wide Beams to destroy the Metroids and release the X. Grab what you can and exit through the door.

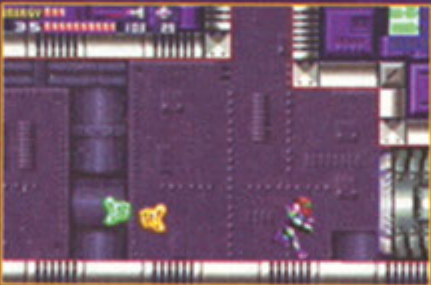
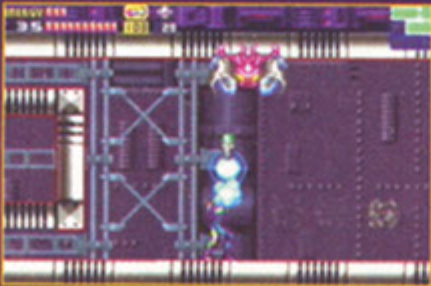

Place a Power Bomb to create an opening in the center of the room. Drop down and blast the Gerubus on the ceiling. Stay away from the yellow and green X so that it can re-form into a gold Space Pirate.

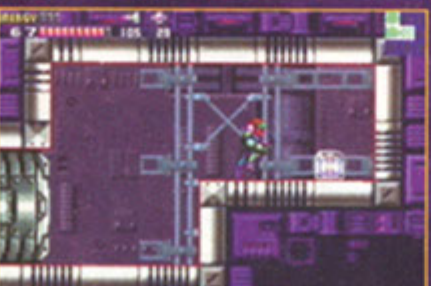

You must shoot the Space Pirate from behind, which is easier said than done. Turn around quickly when the Space Pirate jumps, and fire a missile as soon as the creature hits the

ground. Absorb the X, then proceed through the hatch to collect a Power Bomb Tank.

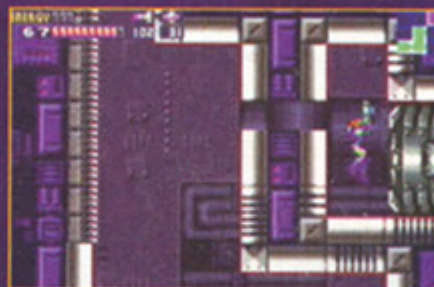
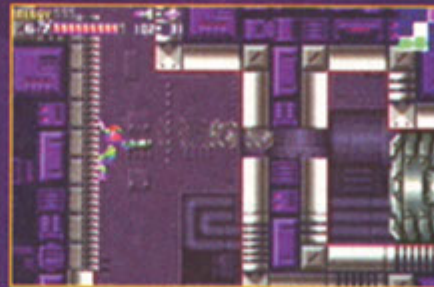
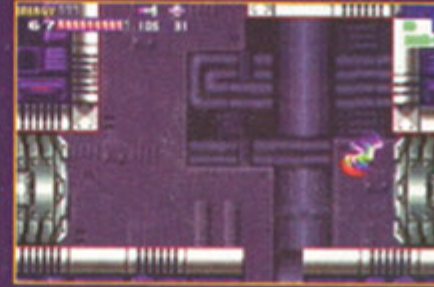

Go back to the left and use Space Jump to fly back up through the opening. Continue up to the ladder on the left, climb halfway up, and fire missiles into the right-hand wall to create an opening. Jump across, morph into a ball, and roll across to the white hatch.

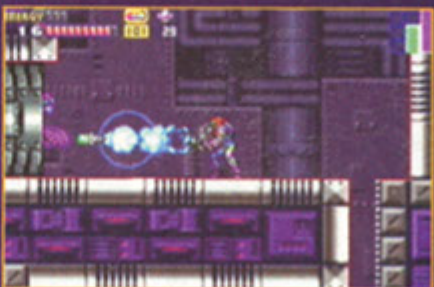
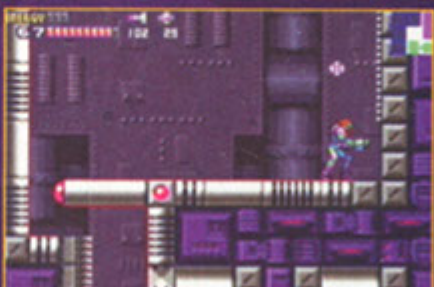

Roll back to the main room and climb up the ladder on the left. Set off a Power Bomb to reveal a ladder on the right. Climb up to the next level, shoot the Space Pirate on the left, and continue through the door.

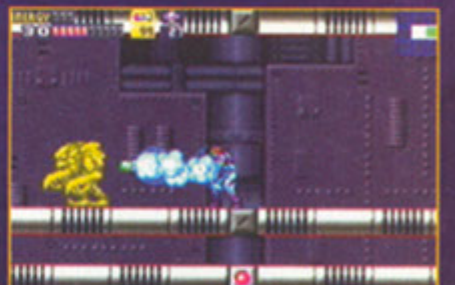
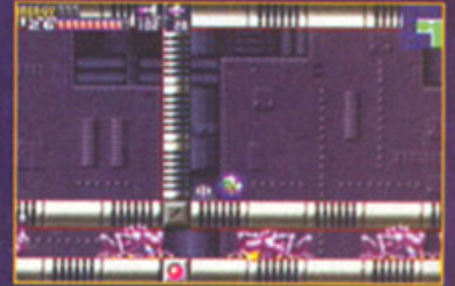

Set off a Power Bomb to clear the barrier. Set off another Power Bomb to clear the creatures from under the floor. A gold Space Pirate appears to the left, firing energy beams from its claws. As in the earlier battle, you can only hurt the gold Space Pirate from behind. Grab the X to keep it from re-forming, and continue to the left through the hatch.

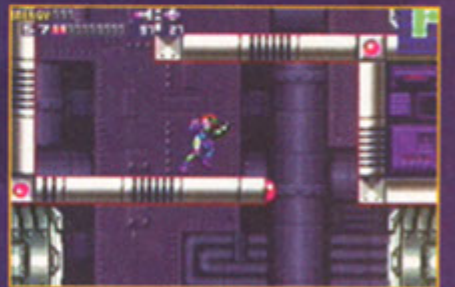

Jump up and go through the hatch on the left to save your game. Exit the Save Room, drop down two levels, and go through the white hatch on the left. Use a Diffusion Missile to freeze all of the Rippers moving back and forth to your left. Jump from Ripper to Ripper to reach the giant eye on the far left. It will start firing when you reach the last floor post.

TIP

If you are low on resources, go through the hatch on the right, jump up, and set off two Power Bombs in the middle of the room. The blasts destroy a group of fire-spitting creatures lurking above the ceiling. Collect the flurry of X that floats down from above. Repeat this process to maximize your weapons and energy before facing Ridley.



Launch another Diffusion Missile to freeze the Rippers when they start moving again, then concentrate your attack on the eye. When you destroy it, collect the powerful red X and continue through the hatch. As Samus steps through the hatch, she drops to the floor, where a giant bird appears to be sleeping. This is Ridley, and it is only playing possum. At first the creature's eye changes color, but momentarily it turns blue and leaps into the air, launching fireballs at Samus.



Move around the room, avoiding Ridley's blasts while firing a steady stream of missiles. Each successful hit turns Ridley white. If you are snatched up in the creature's claws, keep firing. Although you take damage, you can still shoot effectively. While on the ground, watch out for Ridley's tail. It can strike Samus and block missiles. As your attack begins to take its toll, Ridley changes color from blue to purple, and then to red.



Eventually, Ridley stays red and glides back and forth, slamming its tail straight down into the ground. Do your best to avoid these lethal strikes. Keep firing until Ridley explodes, leaving a Core-X. You know the drill. Jump back and forth over the Core-X while firing and collecting X.



When the Core-X shell ruptures, jump up and grab the red X, regaining Samus's Screw Attack ability. This makes Samus all but indestructible, allowing her to somersault and attack, plowing quickly through most creatures.

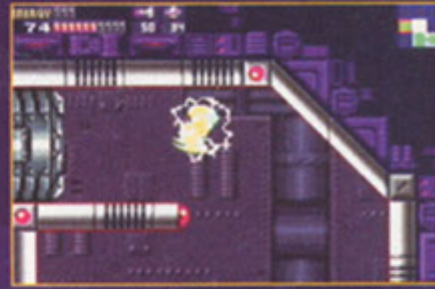

Fly up and to the right, exiting through the hatch. Go back through the Ripper room. This time, there's no need to freeze the little fellas. Just Screw Attack your way through the room and out the white hatch. Fly up and around the barriers to exit through the white hatch on the upper left to save your game.

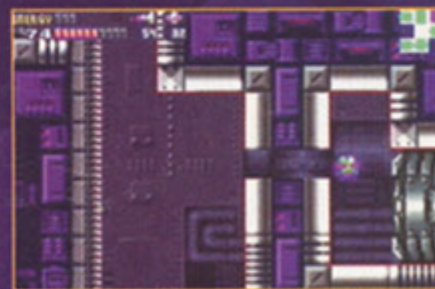
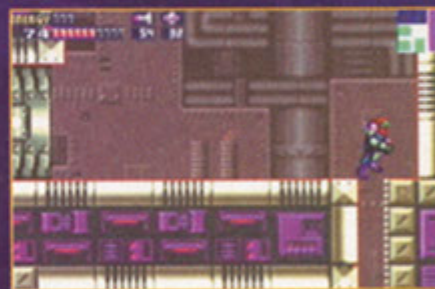
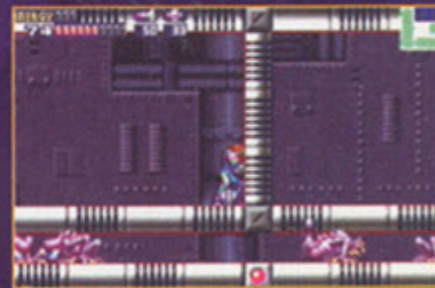

Leave the Save Room and drop one level, exiting to the right. Set off a Power Bomb to clear the barrier, then continue out the door to the right. Plow through the Space Pirate and use a Power Bomb to blow a hole in the floor. Work your way down to

the long ladder, then look for a tube to the right. It's easy to miss if you drop all the way through the hole in the lower floor, so you may need to use Space Jump and fly back up to find it.

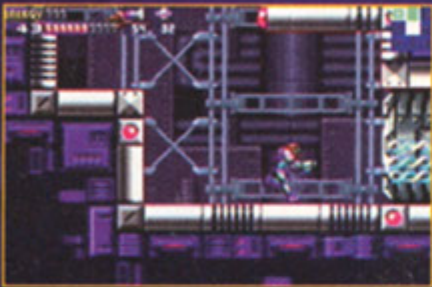
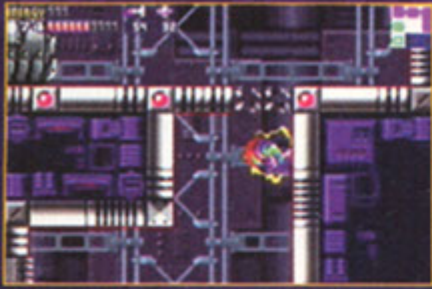

Go through the white hatch, shoot your way past the shutter, and continue through the door into the next room. Use Screw Attack to power through the floor. Work your way down to the bottom level and exit to the right, through the white hatch.

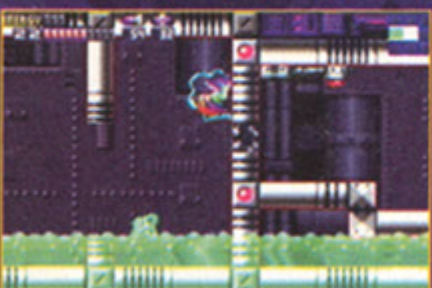
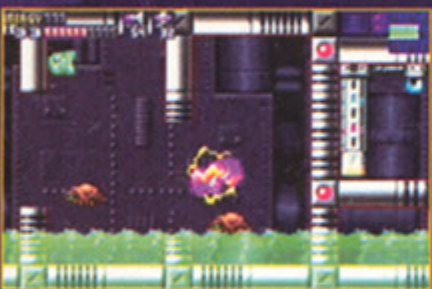

Use Screw Attack to blow through the barriers. When you reach the shutter, use Wave Beam to hit the red light and Screw Attack to push through the last barrier. Proceed through the white hatch.

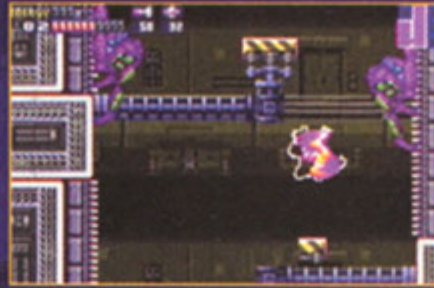

Use Screw Attack to fly up through the vertical chamber, picking off Space Pirates as you move from side to side. Exit to the right when you reach the top, and go quickly through the next cavern to reach another vertical chamber. Take care of more Space Pirates as you move up the walls towards the white hatch on the left.

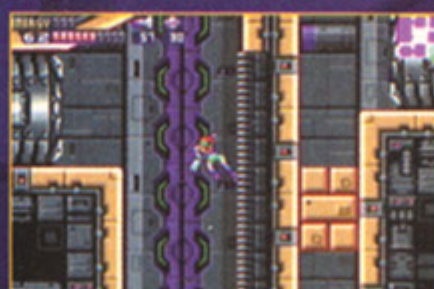
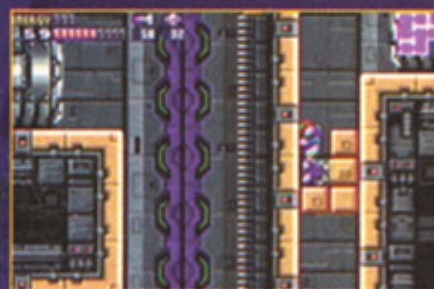

Go past the shutter and through another cavern, exiting to the left. Use Screw Attack as you drop down through the blocks. Go left and up the ladder, and exit through the white hatch.

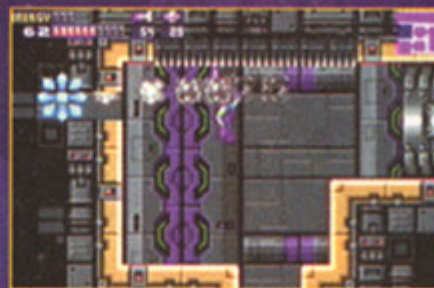
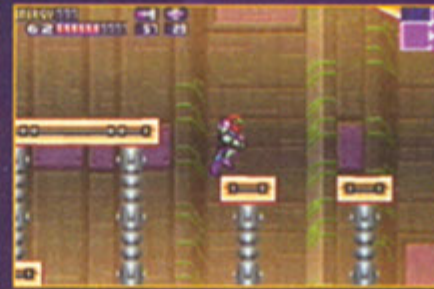

Use the platforms to go up and to the right, exiting through the white hatch. Fly up through the opening and grab the ceiling rungs. Fire missiles to the left to enter a cavern where you'll find a Missile Tank in the lower-right corner.

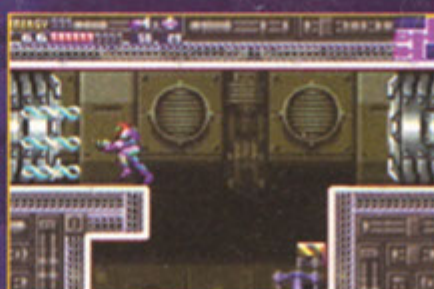

Go back to the previous room and out through the white hatch. Follow the path through the

cavern and exit to the right. Continue past the shutter and into the next vertical chamber. Fly up and out to the left. Follow the platforms up to the white hatch on the left, then go through it to reach another cavern.



Keep working your way to the left through the caverns. After passing through a long corridor, spin up past the yellow platforms to reach the white hatch on the left. Stop at the Recharge Room, save your game, then proceed to the Navigation Room, where Samus receives her final objective.



Main Deck

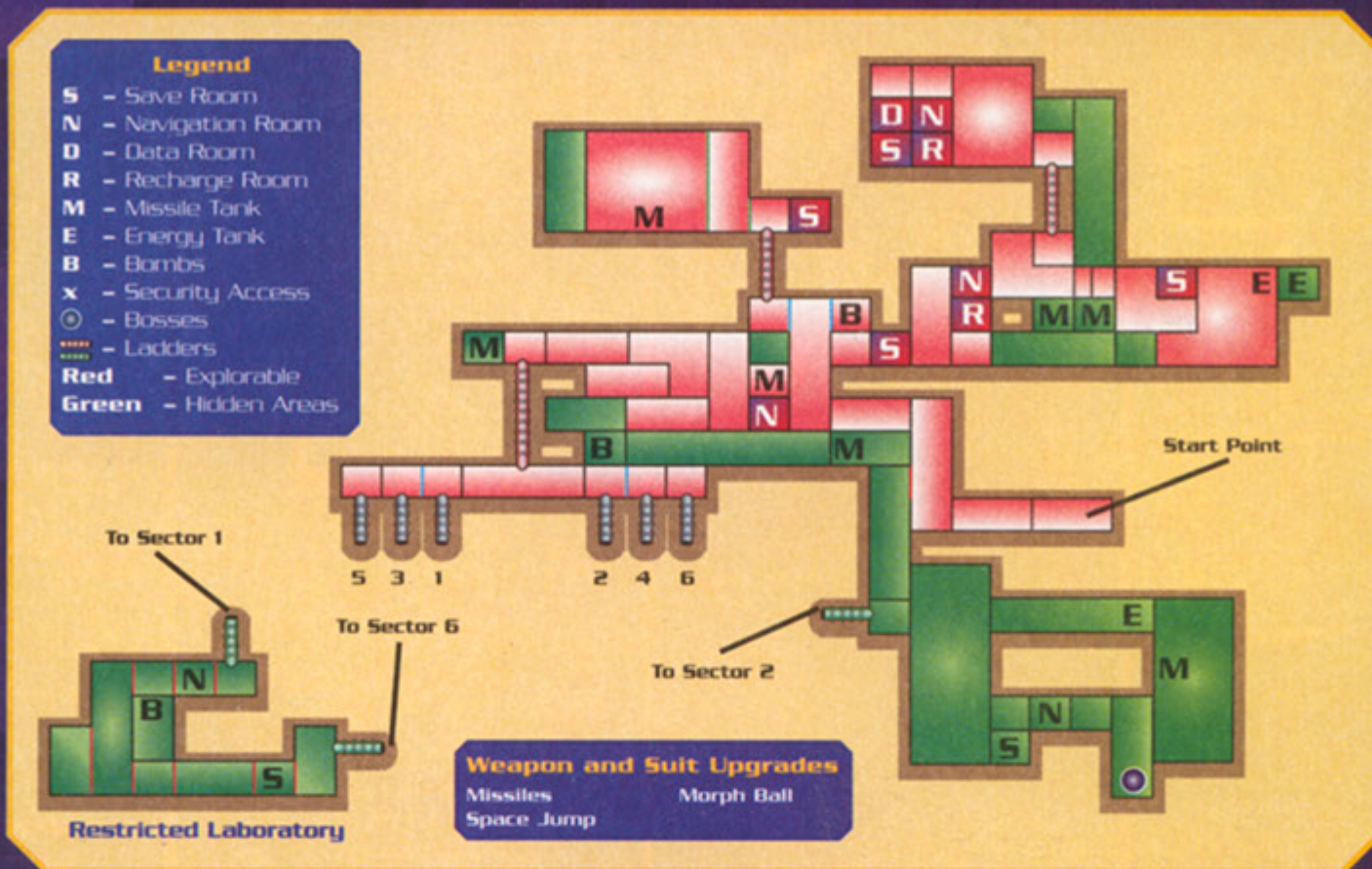

Objective

Samus, we're done here. Leave the rest to the Federation.... We should be preparing to evacuate the station....

Samus: Are you joking?! Do they know how dangerous the X are? How quickly they reproduce?

The Federation has taken an interest in the X and SA-X. They believe this life-form has endless potential applications.

Samus: This is ridiculous! The X are heartless abominations! What potential could they have?

It is not necessary that you understand such matters. The Federation is coming now. You should just leave quietly....

Samus: This is madness! They won't stand a chance here! This station will devour them! What could be worth the risk?

Capturing the SA-X, of course.

Samus: Are you serious? Do they really think they can succeed?

It will certainly be difficult. They don't expect your help. They knew you would try to destroy the SA-X.... That's why they stopped sending you support data.... The Plasma Beam modification was ready some time ago, but they withheld it to keep you from engaging the SA-X. Yet somehow you restored that function on your own.... They also tried to withhold the Diffusion Missile upgrade because they didn't want you to grow too powerful. But they had already sent it, and you tracked it down.... Bravo, Samus.

Samus: They must cancel this mission! Open a channel to HQ! I won't let this happen!

They are already on their way.

Samus: Fools....

Samus makes a commitment to destroy the SA-X, preventing them from spreading beyond the station. She tries to leave through the left-hand hatch, but it won't open. The computer explains.

Objective

Samus: Open the hatch!

I have been ordered to confine you until the ships arrive.

Samus: Don't let them do this. Can't you see what will happen, Adam?

Adam? Who is Adam?

Samus: A friend of mine.

And what would this friend advise you to do now?

Samus: He would know that the only way to end this is to start the self-destruct cycle. He'd know how important it is....

Did this "Adam" care for you? Would he sit in a safe Command Room and order you to die?

Samus: He would understand that some must live and some must die.... He knew what it meant. He made that sacrifice once.

So, he chose life for you? Our fair warrior, Samus Aran.... Your Adam gave his life so that you might keep yours.... For the sake of the universe.... How foolish.

Samus: How dare you! How could you hope to understand, machine?

You know that detonating this station in high orbit would not guarantee the complete extinction of the X parasites even though the station would be utterly destroyed.... You would only succeed in removing the one obstacle to the galaxy's ruin...yourself. You would ignore this simple fact and choose death. When Adam decided who would live, he chose incorrectly.... If you were to alter the station's orbit, then you might be able to include the planet in the vaporization field of the self-destruct detonation.

Samus: ...?

You would have to start the propulsion sequence now. Before the Federation arrives. Samus, this is your last mission. Go to the Operations Room and adjust the station's orbit path to intercept SR-388. Then return to your ship and escape. Move quickly, and stay alive. That's an order! Any objections, Lady?

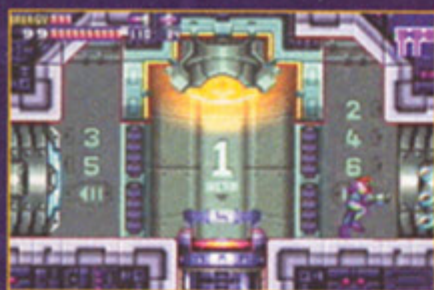

the door in the upper right-hand corner. Use a Power Bomb to clear the plant from your path and go through the door. Morph into a ball and jump up to the ledge. Jump up and roll right to find a hidden passage behind the wall.

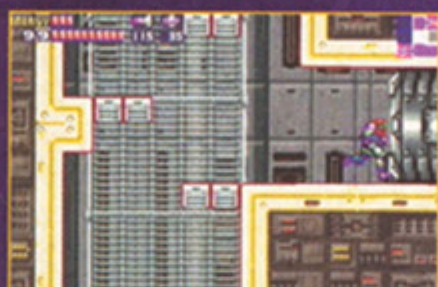

Exit to the left, take the elevator to the Main Deck, and follow the signs to Sector 1. Go right after getting off the elevator. Run through the corridor to activate Speed Booster and blast through the yellow wall. Go through the door to the next room, drop to the ledge, morph, and roll to the right.



Drop down and roll left to pick up the Power Bomb Tank. Continue to the left and detonate a bomb underneath the Bomb Block to return to the room. Drop down to the next level and go to the right through the white hatch. Pass through a short corridor, save your game, and continue into the next room. Jump up one level and go through the white hatch to recharge your weapons and energy.

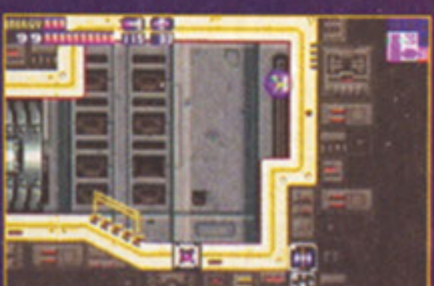
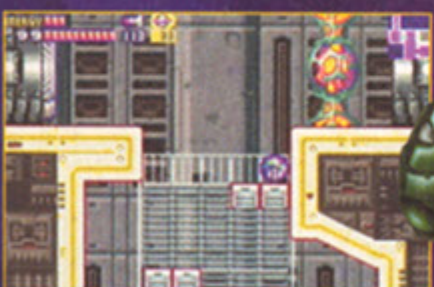

Return to the previous room, drop to the floor, and exit to the right. Go through the Navigation Room and up the ledges to reach



Return to the previous room, go up one level, and pass through the Navigation Room. Jump up the ledges and exit to the right to reach the elevator to the Operations Deck.



When you arrive, go through the hatch to reach the Control Room. Jump around the platforms until you hear a loud thud, signaling the arrival of the SA-X. Missiles don't hurt the SA-X, so you must use charged-up Wave Beams. Establish a pattern of going up to the top shelf on the left and stopping on the right side. When the SA-X arrives, jump off the left side of the shelf and race to the far right corner of the room, charging your beam while running. Fire a charged beam at the SA-X as it runs toward

Samus. When it gets close, repeat the process, jumping up to the top and waiting for the SA-X to follow. Keep this up until the SA-X morphs into a new form, which as you can see, is considerably larger.



Don't let the size scare you. This incarnation is more ugly than dangerous. Continue firing charged beams until it collapses onto the floor.



The next shape is a blue beam Core-X. Use the standard technique of firing, jumping over the Core-X, and firing again when the eye comes into view. You can try to collect the released X, but it disappears rapidly, so you are better off concentrating on the Core-X. Keep jumping left and right until you destroy the Core-X. A blue X cluster is released, but try as you might, you cannot capture it.



Exit through the top-left hatch to reach the Operations Room. Step on the computer pressure pad to change the orbit. You have three minutes to return to your ship.

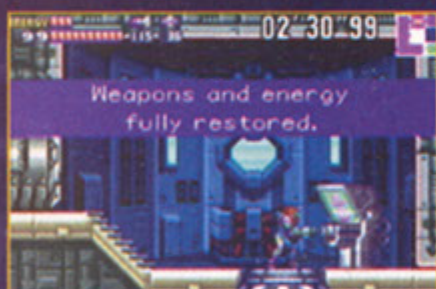
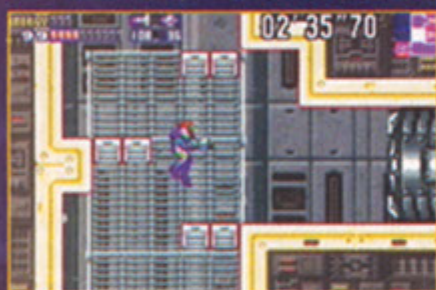

Run back to the left, through the room where you battled the SA-X, and take the elevator down to the Main Deck. Work your way to the left, through the Navigation Room. Drop one level and exit to the right through the white hatch. Step on the pressure pad to recharge your weapons and energy after the SA-X battle.

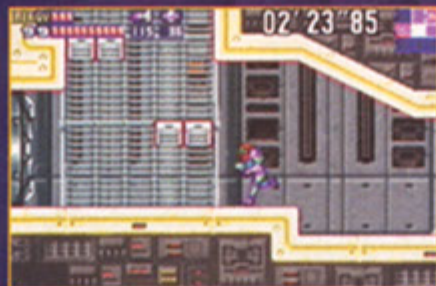

Exit the Recharge Room, drop to the floor, and go to the left through the white hatch. Stop and save your game, then continue to the left, through a short corridor and another white hatch. Drop all the way down to the floor and exit to the right.



Run through the corridor and drop down the vertical chamber toward the Docking Bays (use Screw Attack to smash through the shelves). Exit to the right and go through the wreckage to reach the bays. Samus reaches the bays, but a strange skin blocks her path.



An explosion signals the arrival of the Omega Metroid. A swipe of Omega Metroid's claw temporarily paralyzes Samus, and the beast advances while Samus sits motionless. Suddenly, the blue X floats by and morphs into the SA-X. It steps in front of Samus and attacks the Omega Metroid. It fights valiantly, but another claw swipe turns the SA-X back into X. Jump up and grab the X to restore Samus's weapons and energy. Now it is time for the final battle.



Pump the Omega Metroid with missiles or Wide Beams as fast as you can while staying away from its claws. The Omega Metroid advances to the left each time Samus is hit, and it is easy to be trapped in the corner. Fortunately, the Omega Metroid hops back to the far-right corner, and you have a few moments to recover. Toward the end of the battle when the Omega Metroid is weakening, you are able to inch forward as it backs away, staying close enough to keep firing while avoiding the claws. Keep hammering away until the monster disappears in a puff of biological smoke.



Samus's ship arrives in the Docking Bay to carry Samus to safety. A few secrets are revealed as Samus's ship avoids the mass destruction of the station, but we'll let you find out on your own. Samus is safe, and our job is done!



U.S. \$14.99 Can. \$21.95 U.K. £12.99

Games/Shooter
Platforms: Nintendo GameCube™ and
Game Boy® Advance

**TWO GAMES IN
ONE GUIDE!**

The Hunter has Returned

- ⚡ Complete walkthroughs of **METROID PRIME** and **METROID FUSION**
- ⚡ Detailed maps to help you explore every inch of the terrain
- ⚡ Explanation of Samus's abilities and how weapons enhance them
- ⚡ Every enemy's weak spot revealed
- ⚡ Special morphing strategies
- ⚡ Locations of every power-up, including classics such as Wave Beam and Ice Beam
- ⚡ Special Tactics for destroying every boss for both games
- ⚡ All secret tunnels and breakaway walls exposed
- ⚡ Metroid Prime endings and other secrets Revealed

© 2002 Nintendo. TM, ®, Game Boy Advance, and the Nintendo GameCube logo are trademarks of Nintendo.



David Cassady
Mark Cohen
Tri Pham

primagames.com

The Prima Games logo is a registered trademark of Random House, Inc., registered in the United States and other countries. Primagames.com is a registered trademark of Random House, Inc., registered in the United States.

ISBN 0-7615-3959-X



9 780761 539599



0 86874 53959 4